

windas

High Quality Tools Distributor

Jl.Kelapa Hibrida VIII Ra 23 No 12a
Kelapa Gading, Jakarta 14250
Phone : +62 21 45841539 / 4535134 / 4500784
Fax : +62 21 4513002
Hotline : +62 812 1818784
E-mail : info@windas.co.id
Web : www.windas.co.id
Marketplace : www.tokopedia.com/windas



The Catalogue



Content

Screwdrivers



Kraftform Stainless Steel	20
Kraftform Plus - Series 900	26
Kraftform Plus - Series 300	32
Kraftform Series Comfort	52
Wooden Handle Series	58
Flagdriver Series	61
Screwdriving Accessories	62
Kraftform Micro Series	64
400 T-Handle Series	74
ESD Tools	80

VDE Tools



Kraftform Stainless VDE	88
Kraftform 100 VDE	92
Kraftform Kompakt VDE	106
Kraftform Comfort VDE	120
The Zyklop VDE Ratchet and accessories	124

Ratchets



1/4" Zyklop Speed	144
1/4" Zyklop Metal Push	152
1/4" Zyklop Metal Switch	154
1/4" Zyklop Accessories	156
3/8" Zyklop Speed	172
3/8" Zyklop Metal Push	176
3/8" Zyklop Metal Switch	178
3/8" Zyklop Accessories	180
1/2" Zyklop Speed	190
1/2" Zyklop Hybrid	194
1/2" Zyklop Metal Push	198
1/2" Zyklop Metal Switch	200
1/2" Zyklop Accessories	202
1/2" Koloss	210
Zyklop Mini 1 & 2	214

Joker Combination Ratchet Wrenches



Joker Ratcheting Combination Wrenches	228
Joker Switch Ratcheting Combination Wrenches	230

L-Keys



L-Keys for Hexagon Socket Screws	238
L-Keys for TORX® Screws	250
Offset Screwdrivers	257

Kraftform Kompakt



Kraftform Kompakt 10, 12	262
Kraftform Kompakt 20, 22, 25, 26, 28	264
Kraftform Kompakt 40, 41	268
Kraftform Kompakt 50	269
Kraftform Kompakt 60, 62	270
Kraftform Kompakt 70, 71	276
Kraftform Kompakt 100	278
Kraftform Kompakt User-Specific Sets	280
Bitholding Screwdrivers And Adaptors	284
Kraftform Kompakt Vario With Ratchet Function	288
Kraftform Kompakt Vario Without Ratchet Function	292





















Wera 2go



Wera 2go 1 Tool Carrier	300
Wera 2go 2 Tool Container	300
Wera 2go 3 Tool Box	300
Wera 2go 4 Tool Quiver	300
Wera 2go 5 Tool Carrier	301
Wera 2go 6 Shoulder Strap	301
Hook and Loop Fastener Strips	303

Bits



	Bits For Phillips Screws	316
	Bits For Pozidriv Screws	338
	Bits For Plusminus Screws – Slotted/Phillips	350
	Bits For Plusminus Screws – Slotted/Pozidriv	351
	Bits For TORX® Screws	352
	Bits For TORX® BO Screws	366
	Bits For TORX PLUS® Screws	368
	Bits For TORX PLUS® IPR Screws	372
	Bits For ASSY® Screws	375
	Bits For Slotted Screws Guide Sleeves	376
	Bits For Hexagon Socket Screws	380
	Bits For Hexagon Socket BO Screws	387
	Bits For Square Socket Screws	388
	Bits For TORQ-SET® Screws	392
	Bits For TRI-WING® Screws	395
	Bits For Multi-Point Screws	396
	Bits For Hi-TORQUE Screws	397
	Bits For Microstix® Screws	398
	Bits For Spanner Screws	400
	Nutsetters	401
	Internal Thread Insertion Tool	403

Holder and Adaptors



Impaktor Bit Holders	410
Rapidaptor Bit Holders	414
BiTorsion Bit Holders With Quick-Release Chuck	418
Universal Bit Holders With Quick-Release Chuck	419
Universal Bit Holders With Retaining Ring	421
Universal Bit Holders With Stainless Steel Sleeve	422
Universal Bit Holders With Copper Beryllium Sleeve	424
Bit Holders With adjustable Depth-Control Stop	425
Adaptors	426

Bit Sets



Bit-Checks Impaktor	434
Bit-Checks Stainless	438
Bit-Checks / Bit-Safes BiTorsion	440
Bit-Checks Diamond	444
Bit-Checks / Bit-Safes Universal	448
Bit-Checks Wood	458
Bit-Checks Metal	460
Bit Sets For Special Applications	461

Torque Tools



Series 7400 Adjustable	470
Series 7400 Pre-Set	478
Series Torque-indicators	484
Series Click-Torque	490
Series Insert Tools	502

Impact Driver and Soft-faced Hammers























Impact Driver 90 Nm	510
Soft Faced Hammers	512

TechLex

Technical Compendium	516
Code No. Index	526
Article No. Index	540
Alphabetical Index	551

Tool Index

Tool	Tip type													
	Stainless	Series 900	Series 300	Series Comfort	Wooden Series	Micro Series	400 T-Handle Series	VDE	ESD	Ratchets	L-Keys	Kraftform kompakt	Impact Drivers	Joker
Phillips 	22, 24, 25	28, 30	36, 45, 46, 48, 49, 50	54, 56	60	66, 70, 71, 72		90, 91, 95, 96, 102	80, 81	144ff	257	264ff		
Pozidriv 	22, 24, 25	29, 30, 31	36, 45, 46, 48, 49, 50	54, 56	60	66, 70		90, 91, 95, 96, 102, 103	80	144ff	257	264ff		
PlusMinus Phillips 								97						
PlusMinus Pozidriv 								98, 102						
TORX® TORX® B0 	23	29, 31	38, 39, 40, 45, 50, 51	55		66, 67, 73	76	99, 102, 103	80	144ff	250-256	264ff		
TORX® ZA 														
TORX PLUS® 			40											
TORX PLUS® IPR 						68, 72			80					
ASSY® 														
Slotted 	22, 24, 25	28, 30, 31, 45, 46	34, 35, 45, 48, 49, 50	54, 56	60	66, 70, 71, 72		45, 46, 90, 91, 94, 102	80, 81		257	264ff		
Hexagon Socket 			38			68, 72	76			148ff	238-249	270		
Hexagon Socket B0 														
Square Socket 	23		41, 46, 51					100				266, 271, 272		
TORQ-SET® 			40									273, 276		
TRI-WING® 			42									273, 276		
Multi-Point 														
HTN 														
Microstix® 						68			82					
Spanner 												273, 276		
External Hex 			42, 43, 51			69, 73	77	100, 126, 127	82	144ff				228-232

Your guide to getting the best tools for the job.

														Tool	
1/4"	5/16"	1/4"	7/16"	4 mm	M4	M5	M6	NF2A	4 mm	5 mm	1/4"	5/16"	Tip type		
316-325	332	326-331		335	333	333	334	334	335	336	332	336	Phillips		
338-343	348	344-348			348	349	349						Pozidriv		
		350											PlusMinus Phillips		
		350											PlusMinus Pozidriv		
352-357, 366	361	358-360, 367		364	362	362	363	363	364	365			TORX [®] ZA		
													TORX [®] BO		
				370					370	370			TORX PLUS [®]		
372		369, 373		373					373				TORX PLUS [®] IPR		
375													ASSY [®]		
376-377	379	378											Slotted		
380-381	385	382-384		386									Hexagon Socket		
387		387											Hexagon Socket B0		
388-389	390-391												Square Socket		
392	394	393	394										TORQ-SET [®]		
395	395	395											TRI-WING [®]		
396		396											Multi-Point		
397													HTN		
				398					398				Microstix [®]		
400		400											Spanner		
		401,402							402				External Hex		

Weka

BE A

TOOL

REBEL



What we believe in ...

We believe in challenging the standard

We believe in thinking in a rebellious way

We believe in Rock'n'Roll

We love to be Tool Rebels

The way we challenge the standard is ...

by making the experience for our users ...

easier, safer and full of joy.

We simply create great tools for rebels.

BE A TOOL REBEL



Wera Tools

Passionate staff and a considerable degree of vertical manufacturing integration ensure an unmatched level of tool know-how.



Logistics Center Wera Werkzeuge GmbH, Wuppertal

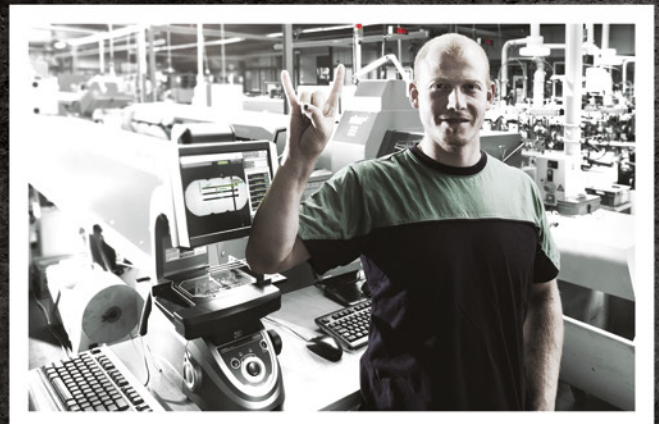



Production plant, Wera Werk Bystřice



Great Tools for Rebels

Kraftform Micro

Precision engineering made easy.



BiTorsion

Bits and holder live longer.



Zyklop Mini

Whenever space is tight.

Kraftform Kompakt

Big content, small size.



Kraftform

Ergonomics you can grasp.



The Chiseldriver

More than just screwdriving.



Zyklus Speed

A really fast mover.

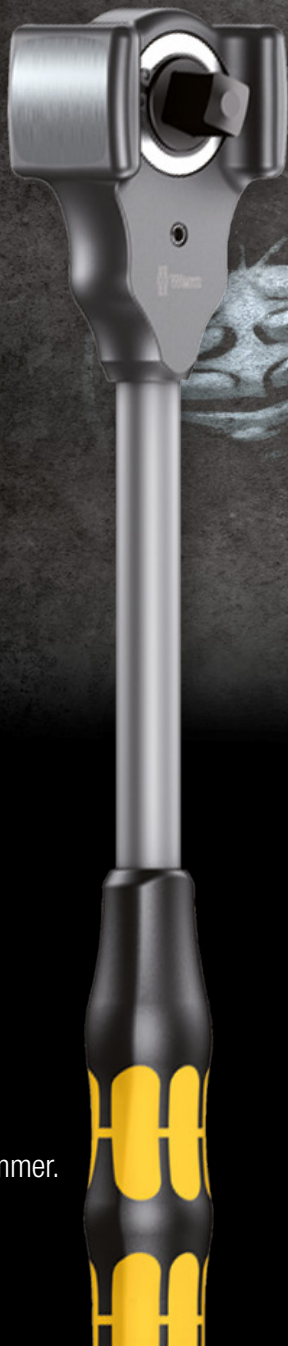

Koloss

Ratchet and hammer.



Lasertip

No more slips when screwdriving.

Joker

With an amazing holding function.



Great Tools for Rebels

Bit-Check

Everything at a glance. Always to hand.



Rapidaptor

More rapid bit change.

Tools in textile boxes

Small size and low weight for simpler mobility.

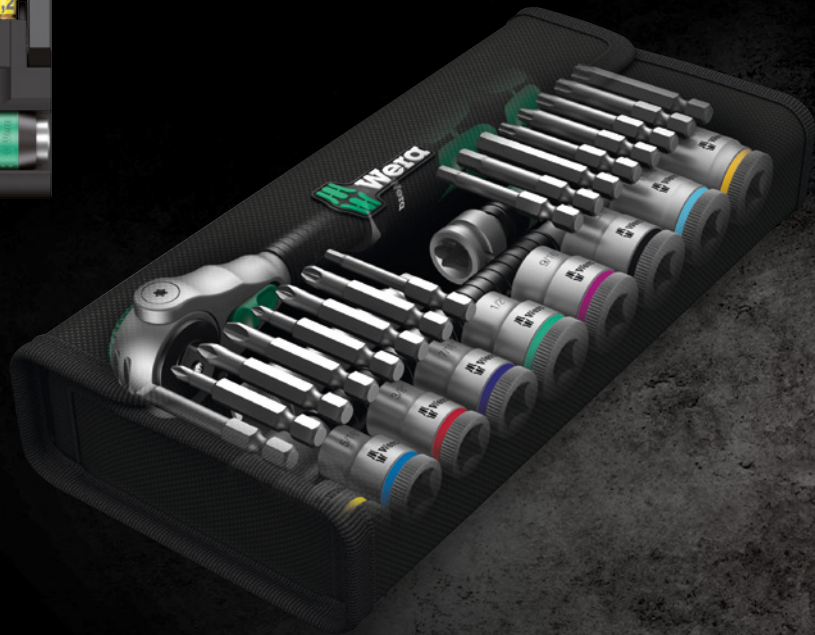

Kraftform Kompakt 20

Getting a handle on things.

Diamond-coated Bits

Bits with "bite".



Impaktor Bits

For extreme situations.



Hex-Plus

Allows hexagon socket screws
a longer service life.



Tools with holding function

Secure holding of screws.



Stainless tools

Attractive and hard.



“Take it easy” Tool finder

Rapid access to the tool thanks
to colour coding.

Great Tools for Rebels



Zyklop VDE
The Zyklop ratchet now in an insulated version.



Wera Belts
Storage of sockets completely revolutionised.



Click-Torque wrenches

The new generation of Wera torque wrenches.



Wera 2go

The space-saving wonder for mobile applications.

We love design

Wera has received several awards for the design of its products and packaging. Including: Red Dot Award, iF Gold Award, German Design Award and German Brand Award Gold.



” Our DNA “











We love Rock'n'Roll







Screwdrivers

	Kraftform Stainless Steel	20
	Kraftform Plus - Series 900	26
	Kraftform Plus - Series 300	32
	Kraftform Series Comfort	52
	Wooden Handle Series	58
	Flagdriver Series	61
	Screwdriving Accessories	62
	Kraftform Micro Series	64
	400 T-Handle Series	74
	ESD Tools	80

Kraftform Stainless Screwdrivers

Why are stainless elements so often affected by rust?

One reason: screwdriving jobs are often carried out with a tool made of conventional steel which can result in extraneous rust forming. This is annoying. We were confident that this could be prevented by using tools likewise out of stainless steel and meeting the required standard of industrial hardness.

A tool series out of stainless steel. The forming of extraneous rust is prevented and a special vacuum ice-hardening process ensures the required degree of hardness.



Solution to the rust problem: screw stainless steel together with stainless steel! Wera stainless steel tools are manufactured out of stainless steel so unsightly rust can be avoided.

The stainless steel tools from Wera are vacuum ice-hardened and have the hardness and strength needed for screw connections. There are no limitations to the industrial applications they are suitable for.



A precisely-focused laser creates a sharp-edged surface structure. This laser treatment results in an edge hardness of up to 1000 HV 0.3. Wera Lasertip "bites" itself into the screw head and prevents any slips out of the recess. It is available for screwdrivers for slotted, Phillips and Pozidriv screws.



Wera Lasertip reduces the contact pressure required and enhances force transfer – meaning less screwdriving effort is required. Screwdriving becomes safer and easier.



The outstanding design of the Kraftform handle that fits perfectly into the hand prevents hand injuries such as blisters and calluses.



The hard materials used for the handle ensure rapid hand repositioning without any danger of the skin “sticking” to the handle. The surrounding hard zones with large diameters glide like wheels across the hand.

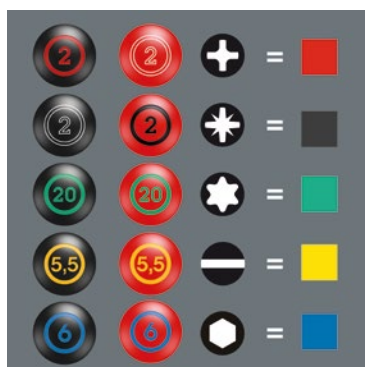

“Take it easy” tool finder: colour coding according to profile and size stamp. This enables faster and more reliable selection of the correct tool from the tool case.

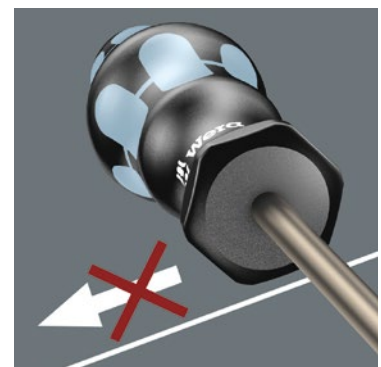

The hexagonal non-roll feature prevents any rolling away at the workplace.

Series Kraftform Screwdrivers Stainless Steel

3335 Screwdriver for slotted screws, stainless



Application: Slotted screws

Blade: Round

Design: Stainless steel for minimising rust, Lasertip

Handle: Kraftform with non-roll feature, multi-component. "Take it easy" tool finder: colour coding according to profile (yellow = slotted) and size stamp.

	┘ mm	┘ mm	∅ mm	┘ mm	┘ mm	┘ "	┘ "
05032001001 ¹⁾	0,5	3,0	3,0	80	81	1/8"	3 1/8"
05032002001	0,6	3,5	3,5	100	81	9/64"	4"
05032003001	0,8	4,0	4,0	100	98	5/32"	4"
05032004001	1,0	5,5	5,5	125	98	7/32"	5"

¹⁾ without Lasertip

3350 PH Screwdriver for Phillips screws, stainless



Application: Phillips screws

Blade: Round

Design: Stainless steel for minimising rust, Lasertip

Handle: Kraftform with non-roll feature, multi-component. "Take it easy" tool finder: colour coding according to profile (red = Phillips) and size stamp.

	+	┘ mm	┘ mm	∅ mm	┘ "
05032020001 ¹⁾	PH 0	60	81	3,0	2 3/8"
05032021001	PH 1	80	98	4,5	3 1/8"
05032022001	PH 2	100	105	6,0	4"
05032023001	PH 3	150	112	8,0	6"

¹⁾ without Lasertip

3334 Screwdriver for slotted screws, stainless



Application: Slotted screws

Blade: Round

Design: Lasertip, stainless steel for minimising rust,

Handle: Kraftform with non-roll feature, multi-component. "Take it easy" tool finder: colour coding according to profile (yellow = slotted) and size stamp.

	┘ mm	┘ mm	∅ mm	┘ mm	┘ mm	┘ "	┘ "
05032005001	1,2	6,5	6,0	150	105	1/4"	6"
05032006001	1,2	8,0	7,0	175	112	5/16"	7"
05032007001	1,6	10,0	9,0	200	112	3/8"	8"

3355 PZ Screwdriver for Pozidriv screws, stainless



Application: Suitable for Pozidriv screws

Blade: Round

Design: Stainless steel for minimising rust, Lasertip

Handle: Kraftform with non-roll feature, multi-component. "Take it easy" tool finder: colour coding according to profile (black = Pozidriv) and size stamp.

	✦	┘ mm	┘ mm	∅ mm	┘ "
05032030001 ¹⁾	PZ 0	60	81	3,0	2 3/8"
05032031001	PZ 1	80	98	4,5	3 1/8"
05032032001	PZ 2	100	105	6,0	4"
05032033001	PZ 3	150	112	8,0	6"

¹⁾ without Lasertip



Tip

3367 Screwdriver for TORX® screws, stainless



Application: TORX® socket screws
Blade: Round
Design: Stainless steel for minimising rust
Handle: Kraftform with non-roll feature, multi-component. "Take it easy" tool finder: colour coding according to profile (green = TORX®) and size stamp.

		mm	mm	mm	"
05032050001	TX 8	60	81	3,5	2 ³ / ₈ "
05032051001	TX 9	60	81	4,0	2 ³ / ₈ "
05032052001	TX 10	80	81	4,0	3 ¹ / ₈ "
05032053001	TX 15	80	98	4,0	3 ¹ / ₈ "
05032054001	TX 20	100	98	4,5	4"
05032055001	TX 25	100	105	5,0	4"
05032056001	TX 27	115	105	5,5	4 ⁹ / ₁₆ "
05032057001	TX 30	115	105	6,0	4 ⁹ / ₁₆ "
05032058001	TX 40	130	112	7,0	5 ³ / ₁₆ "

3368 Screwdriver for square socket screws, stainless



Application: Square socket screws
Blade: Round
Design: Stainless steel for minimising rust
Handle: Kraftform with non-roll feature, multi-component

		mm	mm	mm	"
05032070002	# 1	80	98	4,5	3 ¹ / ₈ "
05032071002	# 2	100	105	6,0	4"

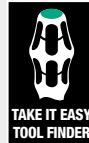

Screwdrivers "Take it easy"

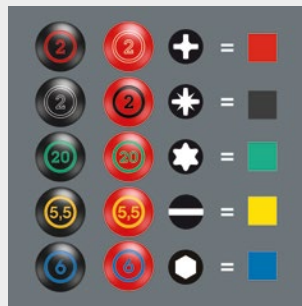

"Take it easy" tool finder: colour coding according to profile and size stamp. This enables faster and more reliable selection of the correct tool from the tool case.



How to prevent the screwdriver from slipping out of the screw head?



It happens time and time again that the tip slips out of the screw head when screwdriving, sometimes damaging valuable surfaces or even causing injury. The tips of the Wera Lasertip screwdrivers are microscopically roughened by means of a laser. This rough surface literally "bites" itself firmly into the screw head. Slipping out becomes a thing of the past.

Vacuum ice-hardened

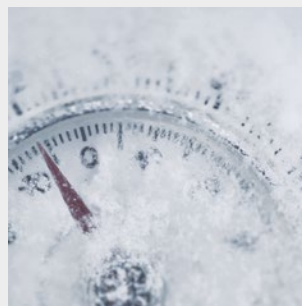

The stainless steel tools from Wera are vacuum ice-hardened and have the hardness and strength needed for screw connections. There are no limitations to the industrial applications they are suitable for.

Series Kraftform Screwdrivers

Stainless Steel

3334/6 Screwdriver set, stainless and rack



Application: Slotted and Phillips screws

Content: 6-piece set with "Take it easy" tool finder: colour coding according to profile and size stamp and rack in display carton

05032060001	
	3350 PH 1 x PH 1x80; 1 x PH 2x100
	3335 1 x 0,5x3,0x80 ¹⁾ ; 1 x 0,8x4,0x100; 1 x 1,0x5,5x125
	3334 1 x 1,2x6,5x150

¹⁾ without Lasertip

3334/3355/6 Screwdriver set, stainless and rack



Application: Slotted and Pozidriv screws

Content: 6-piece set with "Take it easy" tool finder: colour coding according to profile and size stamp and rack in display carton

05032061001	
	3355 PZ 1 x PZ 1x80; 1 x PZ 2x100
	3335 1 x 0,5x3,0x80 ¹⁾ ; 1 x 0,8x4,0x100; 1 x 1,0x5,5x125
	3334 1 x 1,2x6,5x150

¹⁾ without Lasertip



3334/3350/3355/6 Screwdriver set, stainless and rack



Application: Slotted, Phillips and Pozidriv screws

Content: 6-piece set with "Take it easy" tool finder: colour coding according to profile and size stamp and rack in display carton

05032063001		
	3350 PH	1 x PH 1x80; 1 x PH 2x100
	3355 PZ	1 x PZ 1x80; 1 x PZ 2x100
	3335	1 x 0,5x3,0x80 ¹⁾
	3334	1 x 1,2x6,5x150

¹⁾ without Lasertip

Tip



Screwdrivers "Take it easy"

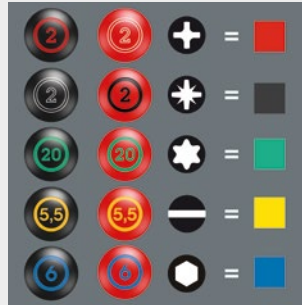

"Take it easy" tool finder: colour coding according to profile and size stamp. This enables faster and more reliable selection of the correct tool from the tool case.



Kraftform



The outstanding design of the Kraftform handle that fits perfectly into the hand prevents hand injuries such as blisters and calluses.



Non-roll feature

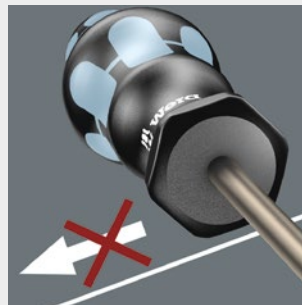

The hexagonal non-roll feature prevents any rolling away at the workplace.

Series 900 – the Chiseldriver

Screwdrivers are often misused as chisels. This can be dangerous.

The chiseldriver is the solution when not only screwdriving is required. For fastening, chiselling and loosening seized screws.

Wera chiseldriver: the screwdriver whenever the going gets tough!



An integrated impact cap lengthens the service life and reduces the danger of splintering. Nevertheless, always wear protective goggles.

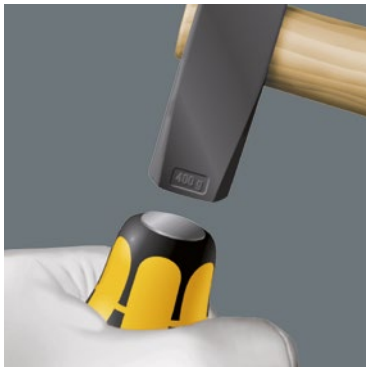

Greater torque can be transferred by fitting an open-jaw or ring spanner over the integrated hex bolster.



The hard materials used for the handle ensure rapid hand repositioning without any danger of the skin “sticking” to the handle. The softer “anti-slip” zones provide increased grip, enabling the low-loss transfer of high forces.

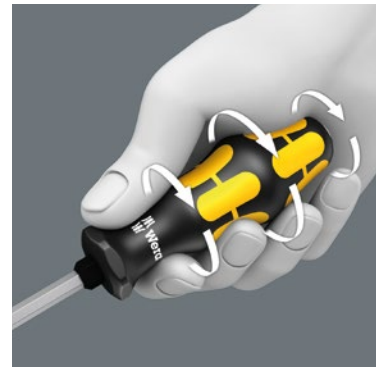

A hexagon blade made out of high-quality bit material extends right through the handle – thereby ensuring full transfer of force, even when struck with a hammer. The ductile tempered material prevents the blade from splintering or breaking.



The outstanding design of the Kraftform handle that fits perfectly into the hand. Prevents hand injuries such as blisters and calluses. Wera Kraftform: a synonym for “graspable” ergonomics!

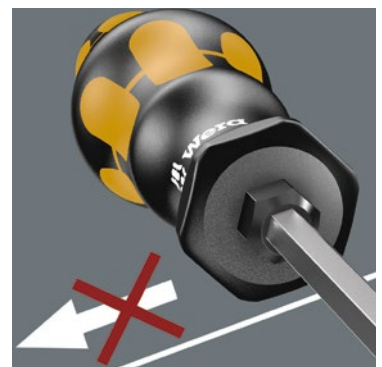

The hexagonal non-roll feature prevents any annoying rolling away at the workplace.



Kraftform Plus – Series 900

The chiseldriver for fastening and chiselling

932 A Screwdriver for slotted screws



- Application:** Slotted screws
- Blade:** Hexagonal throughout with impact cap, hexagonal bolster from 0.8 x 4.5
- Design:** Chrome-plated, Black Point
- Handle:** Kraftform with non-roll feature, multi-component, sizes 2.0 x 12.0, 2.5 x 14.0: Kraftform with non-roll feature, single-component

	mm	mm	mm	mm	mm	mm	mm
05018260001 ¹⁾	0,6	3,5	4		80	81	9/64" 3 1/8"
05018262001	0,8	4,5	5	8	90	98	0,178" 3 1/2"
05018264001	1,0	5,5	6	10	100	105	7/32" 4"
05018266001	1,2	7,0	6	10	125	105	9/32" 5"
05018268001	1,6	9,0	8	13	150	112	11/32" 6"
05018270001	1,6	10,0	8	13	175	112	3/8" 7"
05018272001	2,0	12,0	10	16	200	117	1/2" 8"
05018274001	2,5	14,0	10	16	250	117	9/16" 10"

¹⁾ No throughout blade, no impact cap and no hexagon bolster

932 A SB Screwdriver for slotted screws

		4013288
05100085001	1 x 1.0x5.5x100	181596
05100086001	1 x 1.2x7.0x125	181602
05100087001	1 x 1.6x9.0x150	181619



917 SPHS Screwdriver for Phillips screws



- Application:** Phillips screws
- Blade:** Hexagonal throughout, impact cap with integrated square socket for insertion of 1/4" blades for higher torque
- Design:** Chrome-plated, Black Point
- Handle:** Kraftform with non-roll feature, multi-component

		mm	mm	mm	mm	mm
05017040001	PH 1	5	8	90	98	3 35/64"
05017041001	PH 2	6	10	113	105	4 29/64"

932 AS Screwdriver for slotted screws



- Application:** Slotted screws
- Blade:** Hexagonal throughout, impact cap with integrated square socket for insertion of 1/4" blades for higher torque, hexagonal bolster
- Design:** Chrome-plated, Black Point
- Handle:** Kraftform with non-roll feature, multi-component

	mm	mm	mm	mm	mm	mm	mm
05018300001	0,8	4,5	5	8	100	98	0,178" 4 3/64"
05018301001	1,0	5,5	6	10	113	105	7/32" 4 1/16"
05018302001	1,2	7,0	6	10	138	105	9/32" 5 7/16"

917 SPH Screwdriver for Phillips screws



- Application:** Phillips screws
- Blade:** Hexagonal throughout with impact cap, hexagonal bolster for sizes 1 - 4
- Design:** Chrome-plated, Black Point
- Handle:** Kraftform with non-roll feature, multi-component, size 4/200: Kraftform with non-roll feature, single-component

		mm	mm	mm	mm	mm
05017005001	PH 1	5	8	80	98	3 1/8"
05017010001	PH 2	6	10	100	105	4"
05017015001	PH 3	8	13	150	112	6"
05017020001	PH 4	10	16	200	117	8"

917 SPH SB Screwdriver for Phillips screws

		4013288
05100075001	1 x PH 1x80	181565
05100076001	1 x PH 2x100	181572
05100077001	1 x PH 3x150	181589





918 SPZ Screwdriver for Pozidriv screws



- Application:** Suitable for Pozidriv screws
- Blade:** Hexagonal throughout with impact cap, hexagonal bolster for sizes 1 - 4
- Design:** Chrome-plated, Black Point
- Handle:** Kraftform with non-roll feature, multi-component, size 4/200:
Kraftform with non-roll feature, single-component

		mm	mm	mm	mm	
05017050001	PZ 1	5	8	80	98	3 1/8"
05017052001	PZ 2	6	10	100	105	4"
05017054001	PZ 3	8	13	150	112	6"
05017056001	PZ 4	10	16	200	117	8"

918 SPZ SB Screwdriver for Pozidriv screws

			4013288
05100080001	⊕	1 x PZ 1x80	181633
05100081001	⊕	1 x PZ 2x100	181640
05100082001	⊕	1 x PZ 3x150	181657



977 Screwdriver for TORX® screws



- Application:** TORX® socket screws
- Blade:** Hexagonal throughout with impact cap, hexagonal bolster
- Design:** Chrome-plated, Black Point
- Handle:** Kraftform with non-roll feature, multi-component

		mm	mm	mm	mm	
05024400001	TX 15	5	8	80	98	3 1/8"
05024401001	TX 20	5	8	90	98	3 1/2"
05024402001	TX 25	6	10	100	105	4"
05024403001	TX 27	6	10	125	105	5"
05024404001	TX 30	8	13	150	112	6"
05024405001	TX 40	8	13	150	112	6"

Tip



Why is the Kraftform Plus handle made from several components?



Wera makes its Kraftform handles from several materials with different properties. The core is made from a hardwearing plastic that holds the blade securely even when subjected to great forces. The yellow soft zones of the external mantle consist of a softer material with more friction resistance for high torque transfer. The black areas with a harder surface prevent the hand from sticking to the handle enabling you to adjust your grip more quickly.

Wera makes its Kraftform handles from several materials with different properties. The core is made from a hardwearing plastic that holds the blade securely even when subjected to great forces. The yellow soft zones of the external mantle consist of a softer material with more friction resistance for high torque transfer. The black areas with a harder surface prevent the hand from sticking to the handle enabling you to adjust your grip more quickly.



Wera Black Point tip



The Wera Black Point tip and a refined hardening process ensure long service life of the tip, improved corrosion protection and an exact fit.



Impact cap with integrated square socket

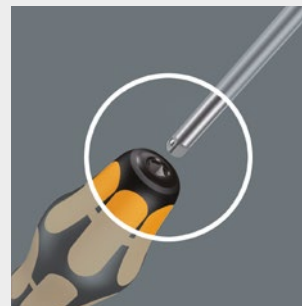

Even higher torque can be transferred by connecting the square drive version to a T-handle or Zyklop ratchet.

Kraftform Plus – Series 900

The chiseldriver for fastening and chiselling

Big Pack 900 Screwdriver set Kraftform Wera: Chiseldriver and rack



Application: Slotted, Phillips, Pozidriv and TORX® socket screws

Content: 13-piece set

	
05133285001	
+	917 SPH 1 x PH 1x80; 1 x PH 2x100; 1 x PH 3x150
+	918 SPZ 1 x PZ 1x80; 1 x PZ 2x100; 1 x PZ 3x150
●	932 A 1 x 0,6x3,5x80 ¹⁾ ; 1 x 0,8x4,5x90; 1 x 1,0x5,5x100; 1 x 1,2x7,0x125; 1 x 1,6x9,0x150
⊕	977 TORX® 1 x TX 20x90; 1 x TX 25x100
	Rack 2 x 190,0x50,0

¹⁾ No throughout blade, no impact cap and no hexagon bolster

932 S/6 Screwdriver set Kraftform Wera: Chiseldriver and rack



Application: Slotted and Phillips screws, impact cap with integrated square socket for insertion of 1/4" blades for higher torque

Content: 6-piece set and rack in display carton

	
05018283001	
+	917 SPHS 1 x PH 1x90; 1 x PH 2x113
●	932 A 1 x 0,6x3,5x80 ¹⁾
●	932 AS 1 x 0,8x4,5x100; 1 x 1,0x5,5x103; 1 x 1,2x7,0x138

¹⁾ No throughout blade, no impact cap and no hexagon bolster

932/6 Screwdriver set Kraftform Wera: Chiseldriver and rack



Application: Slotted and Phillips screws

Content: 6-piece set and rack in display carton

	
05018282001	
+	917 SPH 1 x PH 1x80; 1 x PH 2x100
●	932 A 1 x 0,6x3,5x80 ¹⁾ ; 1 x 0,8x4,5x90; 1 x 1,0x5,5x100; 1 x 1,2x7,0x125

¹⁾ No throughout blade, no impact cap and no hexagon bolster



**932/918/6 Screwdriver set Kraftform Wera:
Chiseldriver and rack**



Application: Slotted and Pozidriv screws
Content: 6-piece set and rack in display carton

05018287001	
+	918 SPZ 1 x PZ 1x80; 1 x PZ 2x100
-	932 A 1 x 0,6x3,5x80 ¹⁾ ; 1 x 0,8x4,5x90; 1 x 1,0x5,5x100; 1 x 1,2x7,0x125

¹⁾ No throughout blade, no impact cap and no hexagon bolster

**977/6 TORX® Screwdriver set Kraftform Wera:
Chiseldriver and rack**



Application: TORX®
Content: 6-piece set and rack in display carton

05024410001	
+	977 TORX® 1 x TX 15x80; 1 x TX 20x90; 1 x TX 25x100; 1 x TX 27x125; 1 x TX 30x150; 1 x TX 40x150



Kraftform Screwdrivers

Series 300

Kraftform Plus screwdrivers – ergonomics you can grasp. They relieve the entire hand-arm system even when used intensively.

Along with other technical and product advantages such as the Lasertip for a secure fit in the screw head, Kraftform screwdrivers are the ideal choice whenever manual screwdriving jobs are concerned.



The outstanding design of the Kraftform handle that fits perfectly into the hand prevents hand injuries such as blisters and calluses.

The hard materials used for the handle ensure rapid hand repositioning without any danger of the skin “sticking” to the handle. The surrounding hard zones with large diameters glide like wheels across the hand.



The basic idea for the prototype of the Kraftform handle – that the hand should dictate the design – has, right through to today, proved to be correct. In cooperation with the internationally recognised Fraunhofer IAO Institute, Wera developed a screwdriver handle designed to match the shape of the human hand as long ago as the 1960s. After a long development phase, the Wera Kraftform handle was launched to the market in 1968. It has been optimised through the years with new technologies, but has kept its proven shape. After all, the human hand has not changed either.



The large contact area – with particularly high friction to the soft zones – results in high torque transfer without any bruising from the edges.



A precisely-focused laser creates a sharp-edged surface structure. This laser treatment results in an edge hardness of up to 1000 HV 0.3. Wera Lasertip “bites” itself into the screw head and prevents any slips out of the recess. It is available for screwdrivers for slotted, Phillips and Pozidriv screws.



Wera Lasertip reduces the contact pressure required and enhances force transfer – meaning less screwdriving effort is required. Screwdriving becomes safer and easier.

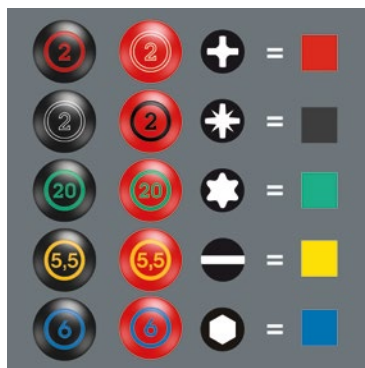

“Take it easy” tool finder: colour coding according to profile and size stamp. This enables faster and more reliable selection of the correct tool from the tool case.

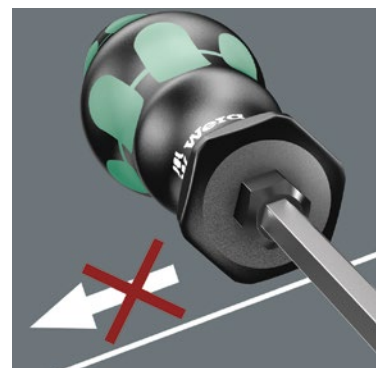

The hexagonal non-roll feature prevents any rolling away at the workplace.

Kraftform Plus – Series 300

The answer to almost every screw.

335 Screwdriver for slotted screws



Application: Slotted screws

Blade: Round

Design: Chrome-plated, Lasertip

Handle: Kraftform with non-roll feature, multi-component. "Take it easy" tool finder: colour coding according to profile (yellow = slotted) and size stamp.

	mm	mm	mm	mm	mm	mm	mm
05008006001 ¹⁾	0,4	2,0	60	70	2,5	5/64"	2 3/8"
05110000001 ¹⁾	0,4	2,5	60	70	2,5	3/32"	2 3/8"
05008007001 ¹⁾	0,4	2,5	75	70	2,5	3/32"	3"
05008008001 ¹⁾	0,5	3,0	150	81	4,0	1/8"	6"
05008009001 ¹⁾	0,5	3,0	200	81	4,0	1/8"	8"
05110001001 ¹⁾	0,5	3,0	80	81	3,0	1/8"	3 1/8"
05008015001	0,6	3,5	100	81	3,5	9/64"	4"
05110002001	0,6	3,5	125	81	3,5	9/64"	5"
05110003001	0,6	3,5	200	81	3,5	9/64"	8"
05110004001	0,8	4,0	100	98	4,0	5/32"	4"
05110005001	0,8	4,0	150	98	4,0	5/32"	6"
05110006001	0,8	4,0	200	98	4,0	5/32"	8"
05008027001 ¹⁾	0,8	4,0	300	98	4,0	5/32"	12"
05110007001	1,0	5,5	125	98	5,5	7/32"	5"
05008055001	1,0	5,5	150	98	5,5	7/32"	6"
05110008001	1,0	5,5	200	98	5,5	7/32"	8"
05008060001 ¹⁾	1,0	5,5	300	98	5,5	7/32"	12"
05008061001	1,2	6,0	100	105	6,0	5/16"	4"

¹⁾ without Lasertip

335 SB Slotted screwdriver

		4013288
05100042001	● 1 x 0.6x3.5x100	181275
05100043001	● 1 x 0.8x4.0x100	181251
05100044001	● 1 x 1.0x5.5x125	181244



334 SK Screwdriver for slotted screws



Application: Slotted screws

Blade: Hexagonal with bolster from 0.8 x 4.5

Design: Chrome-plated, Lasertip

Handle: Kraftform with non-roll feature, multi-component. "Take it easy" tool finder: colour coding according to profile (yellow = slotted) and size stamp.

	mm	mm	mm	mm	mm	mm	mm	
05007670001	0,6	3,5	4	-	75	81	9/64"	3"
05007671001	0,8	4,0	4	-	90	81	5/32"	3 1/2"
05007672001	0,8	4,5	5	8	90	98	0,178"	3 1/2"
05007673001	1,0	5,5	6	10	100	98	7/32"	4"
05007674001	1,2	6,5	6	10	125	105	1/4"	5"
05007675001	1,2	7,0	6	10	125	105	9/32"	5"
05007676001	1,6	9,0	8	13	150	112	11/32"	6"
05007677001	1,6	10,0	8	13	175	112	3/8"	7"

334 Screwdriver for slotted screws



Application: Slotted screws

Blade: Round

Design: Chrome-plated, Lasertip

Handle: Kraftform with non-roll feature, multi-component, sizes 2.0 x 12.0, 2.5 x 14.0: Kraftform with non-roll feature, single-component. "Take it easy" tool finder: colour coding according to profile (yellow = slotted) and size stamp.

	mm	mm	mm	mm	mm	mm	mm
05007610001	0,8	5,0	100	98	5,0	3/16"	4"
05007620001	1,0	6,0	125	105	6,0	1/4"	5"
05340330001	1,0	6,0	150	105	6,0	1/4"	6"
05110010001	1,2	6,5	150	105	6,0	1/4"	6"
05007635001	1,2	7,0	150	105	7,0	9/32"	6"
05007621001	1,2	6,5	200	105	7,0	9/32"	8"
05110011001	1,2	8,0	175	112	7,0	5/16"	7"
05007640001	1,6	8,0	175	112	7,0	5/16"	7"
05110104001	1,6	10,0	200	112	9,0	3/8"	8"
05110105001 ¹⁾	2,0	12,0	250	117	10,0	1/2"	10"

¹⁾ without Lasertip



334 SB Screwdriver for slotted screws

			4013288
051100030001		1 x 1.2x6.5x150	181411
051100031001		1 x 1.2x8.0x175	181220



378 B Screwdriver for slotted screws



Application: Slotted screws

Blade: Square as bolster

Design: Chrome-plated, Black Point

Handle: Kraftform with non-roll feature, multi-component, sizes 2.0 x 12.0 x 250, 2.5 x 14.0 x 225; Kraftform with non-roll feature, single-component. "Take it easy" tool finder: colour coding according to profile (yellow = slotted) and size stamp.

	mm	mm	mm	mm	mm	"	"
05110050001	0,8	4,0	4	75	98	5/32"	3"
05110051001	1,0	5,5	5	100	98	7/32"	4"
05110052001	1,2	6,5	6	125	105	1/4"	5"
05110053001	1,6	8,0	8	150	112	5/16"	6"
05007355001	1,6	10,0	8	60	112	3/8"	2 3/8"
05110054001	1,6	10,0	8	175	112	3/8"	7"
05110150001	1,6	10,0	8	200	112	3/8"	8"
05110055001	2,0	12,0	10	200	112	1/2"	8"
05110151001	2,0	12,0	10	250	112	1/2"	10"

Tip



How to prevent the screwdriver from slipping out of the screw head?



It happens time and time again that the tip slips out of the screw head when screwdriving, sometimes damaging valuable surfaces or even causing injury. The tips of the Wera Lasertip screwdrivers are microscopically roughened by means of a laser. This rough surface literally "bites" itself firmly into the screw head. Slipping out becomes a thing of the past.



Why is the Kraftform Plus handle made out of several components?



Wera produces the Kraftform handle out of several materials with different properties. A resistant plastic is used for the core which ensures that the blade is held securely, even under high strain. A softer material is used for the coloured soft zones, which has a high frictional resistance and allows the transfer of high forces – thus requiring less screwdriving effort. The black sections with their hard surfaces prevent any "sticking" of the hand to the handle, making rapid repositioning of the hand possible.



Wera Black Point tip



The Wera Black Point tip and a refined hardening process ensure long service life of the tip, improved corrosion protection and an exact fit.

Kraftform Plus – Series 300

The answer to almost every screw.

350 SK PH Screwdriver for Phillips screws



Application: Phillips screws

Blade: Hexagonal, sizes 1 - 3 with bolster

Design: Chrome-plated, Lasertip

Handle: Kraftform with non-roll feature, multi-component. "Take it easy" tool finder: colour coding according to profile (red = Phillips) and size stamp.

	+	mm	mm	mm	mm	mm
05008750001 ¹⁾	PH 0	4		60	81	2 3/8"
05008751001	PH 1	5	8	80	98	3 1/8"
05008752001	PH 2	6	10	100	105	4"
05008753001	PH 3	8	13	150	112	6"

¹⁾ without Lasertip

350 PH Screwdriver for Phillips screws



Application: Phillips screws

Blade: Round

Design: Chrome-plated, Lasertip

Handle: Kraftform with non-roll feature, multi-component. "Take it easy" tool finder: colour coding according to profile (red = Phillips) and size stamp.

	+	mm	mm	mm	mm
05008705001 ¹⁾	PH 0	60	81	3,0	2 3/8"
05008706001 ¹⁾	PH 0	100	81	3,0	4"
05008710001	PH 1	80	98	4,5	3 1/8"
05008712001	PH 1	200	98	4,5	8"
05008715001 ¹⁾	PH 1	300	98	4,5	12"
05008720001	PH 2	100	105	6,0	4"
05008723001	PH 2	150	105	6,0	6"
05008725001	PH 2	200	105	6,0	8"
05008730001 ¹⁾	PH 2	300	105	6,0	12"
05008735001	PH 3	150	112	8,0	6"
05008740001 ¹⁾	PH 4	200	112	10,0	8"

¹⁾ without Lasertip

350 PH SB Screwdriver for Phillips screws

		4013288
05100050001	1 x PH 0x60 ¹⁾	181329
05100051001	1 x PH 1x80	181336
05100052001	1 x PH 2x100	181343

¹⁾ without Lasertip





355 SK PZ Screwdriver for Pozidriv screws



Application: Suitable for Pozidriv screws

Blade: Hexagonal, sizes 1 - 3 with bolster

Design: Chrome-plated, Lasertip

Handle: Kraffform with non-roll feature, multi-component. "Take it easy" tool finder: colour coding according to profile (black = Pozidriv) and size stamp.

		mm	mm	mm	mm	mm
05009340001 ¹⁾	PZ 0	4		60	81	2 3/8"
05009341001	PZ 1	5	8	80	98	3 1/8"
05009342001	PZ 2	6	10	100	105	4"
05009343001	PZ 3	8	13	150	112	6"

¹⁾ without Lasertip

355 PZ Screwdriver for Pozidriv screws



Application: Suitable for Pozidriv screws

Blade: Round

Design: Chrome-plated, Lasertip

Handle: Kraffform with non-roll feature, multi-component. "Take it easy" tool finder: colour coding according to profile (black = Pozidriv) and size stamp.

		mm	mm	mm	mm
05009305001 ¹⁾	PZ 0	60	81	3,0	2 3/8"
05009310001	PZ 1	80	98	4,5	3 1/8"
05009312001	PZ 1	200	98	4,5	8"
05009313001 ¹⁾	PZ 1	300	98	4,5	12"
05009315001	PZ 2	100	105	6,0	4"
05009317001	PZ 2	200	105	6,0	8"
05347743001	PZ 2	250	105	6,0	10"
05009319001 ¹⁾	PZ 2	300	105	6,0	12"
05009320001	PZ 3	150	112	8,0	6"
05009325001 ¹⁾	PZ 4	200	112	10,0	8"

¹⁾ without Lasertip

355 PZ SB Screwdriver for Pozidriv screws

		4013288
05100055001	1 x PZ 0x60 ¹⁾	181282
05100056001	1 x PZ 1x80	181299
05100057001	1 x PZ 2x100	181305





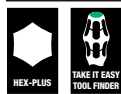

Kraftform Plus – Series 300

The answer to almost every screw.

354 Screwdriver for hexagon socket screws







Application: Hexagon socket screws
Blade: Round
Design: Hex-Plus, chrome-plated
Handle: Kraftform with non-roll feature, multi-component. "Take it easy" tool finder: colour coding according to profile (blue = hexagon) and size stamp.

					
	mm	mm	mm	mm	"
05023105001	2,0	75	70	3,0	3"
05023107001	2,5	75	81	3,0	3"
05023110001	3,0	75	81	4,0	3"
05023115001	4,0	75	98	5,0	3"
05023120001	5,0	80	105	6,0	3 1/8"
05023125001	6,0	80	105	7,0	3 1/8"
05023130001	8,0	100	112	10,0	4"

352 Ball end screwdriver for hexagon socket screws







Application: Hexagon socket screws
Blade: Hexagonal
Design: Ball end hexagon, chrome-plated, Black Point
Handle: Kraftform with non-roll feature, multi-component, sizes W/F 12,0, W/F 1/2": Kraftform with non-roll feature, single-component. "Take it easy" tool finder: colour coding according to profile (blue = hexagon) and size stamp.

					
	mm	mm	mm	mm	"
05022795001	1,5		60	70	2 3/8"
05022800001	2,0		100	70	4"
05138070001	2,5		100	81	4"
05022805001	3,0		100	81	4"
05022810001	4,0		100	98	4"
05022815001	5,0		100	105	4"
05022820001	6,0		125	105	5"
05022825001	8,0		150	112	6"
05022830001	10,0		150	112	6"
05022835001	12,0		150	117	6"
05022905001		5/32"	100	98	4"
05022910001		3/16"	100	105	4"
05022915001		7/32"	100	105	4"
05022920001		1/4"	125	105	5"
05022925001		5/16"	150	112	6"
05022930001		3/8"	150	112	6"
05022935001		1/2"	150	117	6"

367 TORX® HF Screwdriver with holding function for TORX® screws



Application: TORX® socket screws
Blade: Round
Design: Holding function for TORX® screws made according to Acument Intellectual Properties specifications, chrome-plated
Handle: Kraftform with non-roll feature, multi-component

					
		mm	mm	mm	"
05028048001	TX 8	60	81	3,5	2 3/8"
05028049001	TX 9	60	81	4,0	2 3/8"
05028050001	TX 10	80	81	4,0	3 1/8"
05028051001	TX 15	80	98	4,0	3 1/8"
05028052001	TX 20	100	98	4,5	4"
05028070001	TX 20	300	98	4,5	12"
05028053001	TX 25	100	105	5,0	4"
05028071001	TX 25	300	105	6,0	12"
05028054001	TX 27	115	105	5,5	4 9/16"
05028072001	TX 27	300	105	6,0	12"
05028055001	TX 30	115	105	6,0	4 9/16"
05028073001	TX 30	300	105	6,0	12"
05028056001	TX 40	130	112	7,0	5 3/16"



367 Screwdriver for TORX® screws



Application: TORX® socket screws

Blade: Round

Design: Chrome-plated, Black Point

Handle: Krafftform with non-roll feature, multi-component. "Take it easy" tool finder: colour coding according to profile (green = TORX®) and size stamp.

		mm	mm	mm	"
05028000001	TX 5	60	70	3,5	2 3/8"
05028001001	TX 6	60	70	3,5	2 3/8"
05028002001	TX 7	60	70	3,5	2 3/8"
05028003001	TX 8	60	81	3,5	2 3/8"
05028004001	TX 9	60	81	4,0	2 3/8"
05028005001	TX 10	80	81	4,0	3 1/8"
05028008001	TX 15	80	98	4,0	3 1/8"
05028010001	TX 20	100	98	4,5	4"
05028012001	TX 25	100	105	5,0	4"
05028013001	TX 27	115	105	5,5	4 9/16"
05028015001	TX 30	115	105	6,0	4 9/16"
05028020001	TX 40	130	112	7,0	5 1/8"
05028025001	TX 45	130	112	8,0	5 1/8"

367 SB Screwdriver for TORX® screws

		4013288
05100060001	⊕ 1 x TX 10x80	181350
05100061001	⊕ 1 x TX 15x80	181367
05100062001	⊕ 1 x TX 20x100	181374
05100063001	⊕ 1 x TX 25x100	181381
05100064001	⊕ 1 x TX 30x115	181398



Tip



TORX® and hexagon ball tip



The spherical drive profile means that it is possible to swivel the axis of the tool to that of the screw, and therefore enable angled, "around-the-corner" screwdriving jobs. This ball tip geometry – often found on L-keys – is now available on a number of Wera bits.



What is the purpose of the HF profile?



In tight assembly or disassembly situations, for example in engine compartments, it is not possible to securely hold the screw with the hand on the screwdriver, and the screw subsequently often gets lost. Lengthy searches or the loss of the screw (with the associated danger that could bring about) are the consequence. The HF

tools developed by Wera are ideal because they feature an optimised geometry of the original TORX® profile. The wedging forces resulting from the surface pressure between the drive tip and the screw profile mean that the screw is securely held on the tool!



How to prevent rounded screw heads?

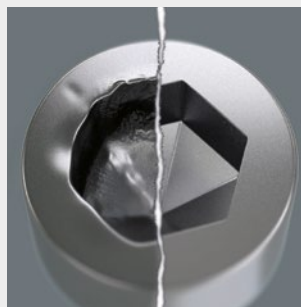

Hexagon socket screws are a problem, because the contact surfaces that transfer the force of the tool to the screw are very narrow. The consequence: the head of the screw can be damaged, usually rounding out the recess. Hex-Plus tools have larger contact surfaces to prevent this, driving from the flats of the recess, rather than the corners.

Good to know: Hex-Plus tools fit into every standard hexagon socket screw!

Kraftform Plus – Series 300

The answer to almost every screw.

367 K Ball end screwdriver for TORX® screws

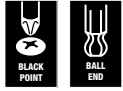

Application: TORX® socket screws

Blade: Round

Design: Ball end, chrome-plated, Black Point

Handle: Kraftform with non-roll feature, multi-component

		mm	mm	mm	"
05027950001	TX 15	80	98	4,0	3 1/8"
05027952001	TX 20	100	98	4,5	4"
05027954001	TX 25	100	105	5,0	4"
05027956001	TX 27	115	105	5,5	4 9/16"
05027958001	TX 30	115	105	6,0	4 9/16"

367 TORX® BO Screwdriver for tamper-proof TORX® screws



Application: TORX® screws with safety pin

(BO = with bore hole)

Blade: Round

Design: Bore hole in TORX® section, chrome-plated, Black Point

Handle: Kraftform with non-roll feature, multi-component

		mm	mm	mm	"
05138257001	TX 7	60	70	3,5	2 3/8"
05138258001	TX 8	60	81	3,5	2 3/8"
05138259001	TX 9	60	81	4,0	2 3/8"
05138260001	TX 10	80	81	4,0	3 1/8"
05138268001	TX 10	300	81	4,0	12"
05138261001	TX 15	80	98	4,0	3 1/8"
05138269001	TX 15	300	98	4,0	12"
05138262001	TX 20	100	98	4,5	4"
05138270001	TX 20	300	98	4,5	12"
05138263001	TX 25	100	105	5,0	4"
05138264001	TX 27	115	105	5,5	4 9/16"
05138265001	TX 30	115	105	6,0	4 9/16"
05138266001	TX 40	130	112	7,0	5 3/16"

367 TORX PLUS® Screwdriver for TORX PLUS® screws



Application: TORX PLUS® socket screws

Blade: Round

Design: Chrome-plated, Black Point

Handle: Kraftform with non-roll feature, multi-component

		mm	mm	mm	"
05028029001	5 IP	60	70	3,5	2 3/8"
05028030001	6 IP	60	70	3,5	2 3/8"
05028031001	7 IP	60	70	3,5	2 3/8"
05028032001	8 IP	60	70	3,5	2 3/8"
05028033001	9 IP	60	81	4,0	2 3/8"
05028034001	10 IP	80	81	4,0	3 1/8"
05028035001	15 IP	80	98	4,0	3 1/8"
05028036001	20 IP	100	98	4,5	4"
05028037001	25 IP	100	105	5,0	4"
05028038001	30 IP	115	105	6,0	4 9/16"

371 TORQ-SET® Mplus screwdriver for TORQ-SET® screws



Application: TORQ-SET® screws

Blade: Round

Design: Mplus for higher breaking torque and longer service life, chrome-plated

Handle: Kraftform with non-roll feature, multi-component

	mm	mm	mm	mm	"
05028130001	6	80	98	4,5	3 1/8"
05028132001	8	100	105	6,0	4"
05028134001	10	100	105	6,0	4"
05028136001	1/4"	125	112	8,0	5"



Tip

How can I prevent frequent breakages of TORQ-SET® tools?

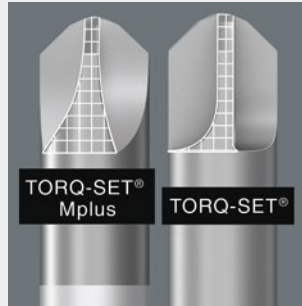

Wera developed the Mplus profile with stronger flanks compared with tools with a conventional TORQ-SET® profile. This results in approximately 70 % extra torsional strength and greatly extends the service life of Wera Mplus tools.

368 Screwdriver for square socket head screws



- Application:** Square socket screws
- Blade:** Round
- Design:** Chrome-plated, Black Point except for sizes 01+02
- Handle:** Kraffform with non-roll feature, multi-component, # 2/300, # 01/25, # 02/25: single-component

		mm	mm	mm	
05117680001		# 00	60	81	3,5 2 3/8"
05117681001		# 0	60	81	4,0 2 3/8"
05117682001		# 1	80	98	4,5 3 1/8"
05117683001		# 1	200	98	4,5 8"
05117684001		# 2	100	105	6,0 4"
05117685001		# 2	200	105	6,0 8"
05117691001		# 2	300	105	6,0 12"
05117686001		# 3	150	112	8,0 6"
05117687001		# 4	200	112	8,0 8"
05117688001		# 01	25	54	4,5 1"
05117689001		# 02	25	54	6,0 1"

368 SB Screwdriver for square socket head screws

		4013288
05100070001	1 x # 1x80	181404
05100071001	1 x # 2x100	181428
05100072001	1 x # 3x150	181435



TORX PLUS®



Compared with the "normal" TORX® profile, the elliptical instead of circular profile enlarges the 6 flanks that transfer torque between the tool and the screw. This means that the force applied when screwdriving is spread across a larger surface area. Higher torque is transferred and, in addition, the service life of the screw and tool are lengthened. The so-called centre-lock screws on cutting tools represent a typical use of this type of screw profile. The thermal influences on such holders for carbide insert tips often "bake" the retaining screws so firmly that it is important to have

a profile that considerably enhances the loosening torque capability of the screws. For this reason a torque-stable screw profile is necessary to avoid any possible damage to the screw and to exclude the possibility of an otherwise costly machine downtime.

TORX® with borehole (BO)

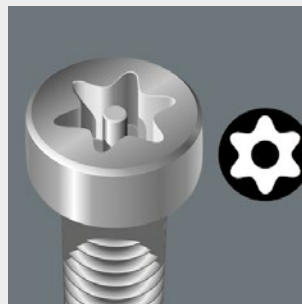

TORX® tools with a borehole prevent the unauthorised unfastening of safety screws. The screws contain a pin that protrudes into the drive profile so that "normal" TORX® tools cannot be used. This pin fits into the borehole of TORX® BO tools allowing safety screws to be unfastened.

Kraftform Plus – Series 300

The answer to almost every screw.

375 TRI-WING® screwdriver for TRI-WING® screws



Application: TRI-WING® screws
Blade: Round
Design: Chrome-plated, Black Point
Handle: Kraftform with non-roll feature, multi-component

		mm	mm	mm	
05028116001	0	80	81	3,5	3 1/8"
05028118001	1	80	81	3,5	3 1/8"
05028120001	2	80	98	4,5	3 1/8"
05028122001	3	80	98	4,5	3 1/8"
05028124001	4	100	98	6,0	4"
05028126001	5	100	98	6,0	4"

395 Nutdriver



Application: Hexagon headed bolts, screws and nuts
Blade: Round
Design: Chrome-plated, nutdriver for hexagon head bolts
Handle: Kraftform with non-roll feature, multi-component

	mm	mm	mm	mm	
05028205001	3,0	125	98	5,0	5"
05028210001	3,5	125	98	6,1	5"
05028215001	4,0	125	98	6,9	5"
05028220001	4,5	125	98	7,1	5"
05028225001	5,0	125	98	8,1	5"
05028230001	5,5	125	98	8,1	5"
05029405001	6,0	125	98	9,1	5"
05029410001	7,0	125	105	11,0	5"
05029415001	8,0	125	105	12,1	5"
05029420001	9,0	125	105	13,1	5"
05029425001	10,0	125	112	14,1	5"
05029430001	11,0	125	112	16,0	5"
05029435001	12,0	125	112	17,1	5"
05029440001	13,0	125	112	18,1	5"
05029445001	14,0	125	112	19,1	5"
05029450001	15,0	125	112	21,0	5"

391 Hose clamp screwdriver



Application: Hexagon headed bolts, screws and nuts
Blade: Round, flexible
Design: Nutdriver for hexagon head bolts
Handle: Kraftform with non-roll feature, multi-component

	mm	mm	mm	
05028148001	6	167	98	6 9/16"
05028150001	7	167	98	6 9/16"
05028152001	8	167	98	6 9/16"

395 HO Nutdriver









Application: Hexagon headed bolts, screws and nuts

Blade: Round

Design: Chrome-plated, hollow shaft for protruding threaded rods

Handle: Kraftform with non-roll feature, multi-component

TIP: The hollow shaft enables seized screws or those on long threads to be tightened and loosened

						
	mm	mm	mm	mm	mm	mm
05029460001	5,0	90	98	7,2	3 35/64"	3 35/64"
05029461001	5,5	90	98	7,2	3 35/64"	3 35/64"
05029462001	6,0	90	98	7,2	3 35/64"	3 35/64"
05029463001	7,0	90	105	7,2	3 35/64"	3 35/64"
05029464001	8,0	90	105	9,3	3 35/64"	3 35/64"
05029465001	10,0	90	112	9,3	3 35/64"	3 35/64"
05029466001	13,0	90	112	11,0	3 35/64"	3 35/64"
05029501001		3/16"	90	98	7,2	3 35/64"
05029502001		1/4"	90	98	7,2	3 35/64"
05029503001		5/16"	90	105	9,3	3 35/64"
05029504001		11/32"	90	105	9,3	3 35/64"
05029505001		3/8"	90	112	9,3	3 35/64"
05029506001		7/16"	90	112	11,0	3 35/64"
05029507001		1/2"	90	112	11,0	3 35/64"

Tip



What is the purpose of a screwdriver with hollow shaft?

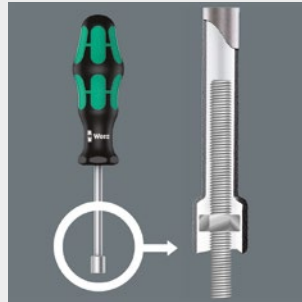

A screwdriver with a hollow shaft is needed whenever there are screwdriving jobs involving threaded rods i.e. the threaded rod through the nut can slip into the hollow shaft of the screwdriver.



Flexible shaft



Screwdriving can also be achieved "around the corner" with the screwdriver 391. The flexible shaft allows unfavourably-positioned screw fastenings to be reached. The ideal tool for difficult-to-access screwdriving applications e.g. in the engine compartment of a car.

The TRI-WING® screwdriving system



The TRI-WING® screwdriving system is mainly found in aviation and household technology (here e.g. on live components). The asymmetric arrangement of the three profile flanks prevents the use of anything other than the original tools. The high-precision Wera profile design ensures a secure fit of the tool in the head of the screw. The blades are manufactured out of bit material. The Wera know-how with regard to the hardening technology ensures a long service life of the tool.

Kraftform Plus – Series 300

The answer to almost every screw.

336 Stubby/Carburettor screwdriver









Application: Slotted screws

Blade: Round

Design: Chrome-plated, Black Point

Handle: Kraftform with non-roll feature, single-component

	 mm	 mm	 mm	 mm	 mm	 mm	 mm
05110068001	0,6	3,5	25	54	3,5	$\frac{9}{64}$ "	1"
05110069001	0,8	4,0	25	54	4,0	$\frac{5}{32}$ "	1"
05110070001	1,0	5,5	25	54	5,5	$\frac{7}{32}$ "	1"
05110075001	1,2	6,5	25	54	6,5	$\frac{1}{4}$ "	1"
05110078001	1,2	8,0	25	54	8,0	$\frac{5}{16}$ "	1"

Stubby/Carburettor screwdriver







Application: Phillips screws

Blade: Round

Design: Chrome-plated, Black Point

Handle: Kraftform, with non-roll feature, single-component

		 mm	 mm	 mm	 mm
05008775001	PH 01	25	54	4,5	1"
05008780001	PH 02	25	54	6,0	1"
05008782001	PH 03	25	54	8,0	1"

Stubby/Carburettor screwdriver







Application: Suitable for Pozidriv screws

Blade: Round

Design: Chrome-plated, Black Point

Handle: Kraftform with non-roll feature, single-component

		 mm	 mm	 mm	 mm
05009330001	PZ 01	25	54	4,5	1"
05009335001	PZ 02	25	54	6,0	1"
05009337001	PZ 03	25	54	8,0	1"



Kraftform Big Pack 300

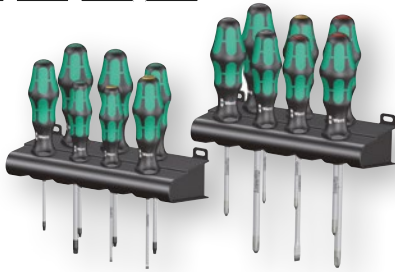

Kraftform Plus – Series 300. With Lasertip blade, voltage tester and rack. “Take it easy” tool finder: colour coding according to profile and size stamp.

Application: Slotted, cross, Phillips-Recess, Pozidriv and TORX® screws

Content: 14-piece set in display carton

05105630001		
+	350 PH	1 x PH 1x80; 1 x PH 2x100; 1 x PH 3x150
+	355 PZ	1 x PZ 1x80; 1 x PZ 2x100; 1 x PZ 3x150
+	367 TORX®	1 x TX 10x80; 1 x TX 15x80; 1 x TX 20x100; 1 x TX 25x100; 1 x TX 30x115
+	334	1 x 1,2x6,5x150
+	335	1 x 0,6x3,5x100; 1 x 0,8x4,0x100
	Rack	2 x 190,0x50,0

Kraftform XXL



12-piece screwdriver set for all-round applications. “Take it easy” tool finder: colour coding according to profile and size stamp.

05051010001		
+	350 PH	1 x PH 1x80; 1 x PH 2x100
+	355 PZ	1 x PZ 1x80; 1 x PZ 2x100
+	932 A	1 x 1,0x5,5x100; 1 x 1,2x7,0x125
+	334	1 x 1,2x6,5x150
+	335	1 x 0,8x4,0x100; 1 x 1,0x5,5x125
+	160 i VDE	1 x 0,4x2,5x80 ¹⁾ ; 1 x 0,6x3,5x100
+	247	1 x 0,5x3,0x70
	Rack	2 x 190,0x50,0

¹⁾ without Lasertip

²⁾ Product not available in the USA and Canada.

Tip



Screwdrivers “Take it easy”



“Take it easy” tool finder: colour coding according to profile and size stamp. This enables faster and more reliable selection of the correct tool from the tool case.



The Chiseldriver

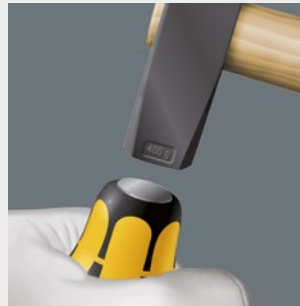

An integrated impact cap lengthens the service life and reduces the danger of splintering. Nevertheless, always wear protective goggles.

Kraftform Plus – Series 300

The answer to almost every screw.

Kraftform XXL 2



12-piece screwdriver set for all-round applications. "Take it easy" tool finder: colour coding according to profile and size stamp.

05051011001		
+	350 PH	1 x PH 2x100
+	355 PZ	1 x PZ 1x80; 1 x PZ 2x100
+	932 A	1 x 1,0x5,5x100; 1 x 1,2x7,0x125
+	335	1 x 0,8x4,0x100
+	367 TORX®	1 x TX 15x80; 1 x TX 20x100; 1 x TX 25x100
+	160 i VDE	1 x 0,4x2,5x80 ¹⁾ ; 1 x 0,6x3,5x100
+	247	1 x 0,5x3,0x70
	Rack	2 x 190,0x50,0

¹⁾ without Lasertip

²⁾ Product not available in the USA and Canada.

Kraftform XXL 3



11-piece screwdriver set for all-round applications. "Take it easy" tool finder: colour coding according to profile and size stamp.

05347106001		
+	160 i VDE	1 x 0,4x2,5x80 ¹⁾ ; 1 x 0,6x3,5x100
+	350 PH	1 x PH 1x80; 1 x PH 2x100
+	932 A	1 x 1,0x5,5x100; 1 x 1,2x7,0x125
+	335	1 x 0,8x4,0x100; 1 x 1,0x5,5x125
+	334	1 x 1,2x6,5x150
+	368	1 x # 1x80; 1 x # 2x100
	Rack	2 x 190,0x50,0

¹⁾ without Lasertip

Kraftform 2go 300



11 Kraftform screwdrivers, Series 300 for cross recess screws Phillips and Pozidriv, TORX® and slotted screws. "Take it easy" tool finder: colour coding according to profile and size stamp.

1 dimensionally stable and robust Tool Quiver, equipped with handle for the storage and transport of tools; high resistance against cuts and stabs; comes with hook and loop fastener zone for docking with the Wera 2go system and includes 1 variably adjustable hook and loop fastener partition for a division into as many as 5 sections.

05004313001		
	Wera 2go 4	1 x 165,0x165,0x105
+	350 PH	1 x PH 1x80; 1 x PH 2x100
+	355 PZ	1 x PZ 1x80; 1 x PZ 2x100
+	367 TORX®	1 x TX 10x80; 1 x TX 15x80; 1 x TX 20x100; 1 x TX 25x100; 1 x TX 30x115
+	334 SK	1 x 0,8x4,5x90; 1 x 1,2x7,0x125
	Hook and Loop Fastener Strip	1 x 50,0x120,0



Kraftform Plus – Series 300

The answer to almost every screw.

334 SK/6 Rack screwdriver set Kraftform Plus Lasertip and rack



Lasertip hexagon blades and rack. "Take it easy" tool finder: colour coding according to profile and size stamp.

Application: Slotted and Phillips screws

Content: 6-piece set and rack in display carton

05007680001	
+	350 SK PH 1 x PH 1x80; 1 x PH 2x100
-	334 SK 1 x 0,6x3,5x75; 1 x 0,8x4,0x90; 1 x 1,0x5,5x100; 1 x 1,2x6,5x125

334/355 SK/6 Screwdriver set Kraftform Plus Lasertip and rack



Lasertip hexagonal blades and rack. "Take it easy" tool finder: colour coding according to profile and size stamp.

Application: Slotted and Pozidriv screws

Content: 6-piece set and rack in display carton

05007681001	
+	355 SK PZ 1 x PZ 1x80; 1 x PZ 2x100
-	334 SK 1 x 0,6x3,5x75; 1 x 0,8x4,0x90; 1 x 1,0x5,5x100; 1 x 1,2x6,5x125

334/6 Rack screwdriver set Kraftform Plus Lasertip and rack



Lasertip round blades and rack. "Take it easy" tool finder: colour coding according to profile and size stamp.

Application: Slotted and Phillips screws

Content: 6-piece set and rack in display carton

05105650001	
+	350 PH 1 x PH 1x80; 1 x PH 2x100
-	334 1 x 1,2x6,5x150
-	335 1 x 0,5x3,0x80 ¹⁾ ; 1 x 0,8x4,0x100; 1 x 1,0x5,5x125

¹⁾ without Lasertip

334/355/6 Rack screwdriver set Kraftform Plus Lasertip and rack



Lasertip round blades and rack. "Take it easy" tool finder: colour coding according to profile and size stamp.

Application: Slotted and Pozidriv screws

Content: 6-piece set and rack in display carton

05105656001	
+	355 PZ 1 x PZ 1x80; 1 x PZ 2x100
-	334 1 x 1,2x6,5x150
-	335 1 x 0,5x3,0x80 ¹⁾ ; 1 x 0,8x4,0x100; 1 x 1,0x5,5x125

¹⁾ without Lasertip



335/350/355/6 Screwdriver set Kraftform Plus Lasertip and rack



Lasertip blades and rack. "Take it easy" tool finder: colour coding according to profile and size stamp.

Application: Slotted, Phillips and Pozidriv screws

Content: 6-piece set and rack in display carton

05105622001		
+	350 PH	1 x PH 1x80; 1 x PH 2x100
*	355 PZ	1 x PZ 1x80; 1 x PZ 2x100
-	335	1 x 0,8x4,0x100; 1 x 1,0x5,5x125

335/350/355/3 Screwdriver set Kraftform Plus with holding function and 300 mm-long blades

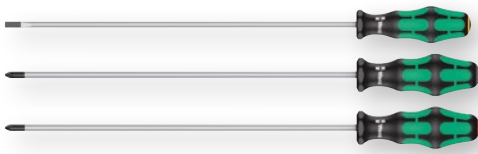

"Take it easy" tool finder: colour coding according to profile and size stamp.

Application: Slotted, Phillips and Pozidriv screws

Content: 3-piece set

05347735002		
+	350 PH	1 x PH 2x300 ¹⁾
*	355 PZ	1 x PZ 2x300 ¹⁾
-	335	1 x 1,0x5,5x300 ¹⁾

¹⁾ without Lasertip

Tip



Screwdrivers "Take it easy"



"Take it easy" tool finder: colour coding according to profile and size stamp. This enables faster and more reliable selection of the correct tool from the tool case.



How to prevent the screwdriver from slipping out of the screw head?



It happens time and time again that the tip slips out of the screw head when screwdriving, sometimes damaging valuable surfaces or even causing injury. The tips of the Wera Lasertip screwdrivers are microscopically roughened by means of a laser. This rough surface literally "bites" itself firmly into the screw head. Slipping out becomes a thing of the past.



Why is the Kraftform Plus handle made out of several components?



Wera produces the Kraftform handle out of several materials with different properties. A resistant plastic is used for the core which ensures that the blade is held securely, even under high strain. A softer material is used for the coloured soft zones, which has a high frictional resistance and allows the transfer of high forces – thus requiring less screwdriving effort. The black sections with their hard surfaces prevent any "sticking" of the hand to the handle, making rapid repositioning of the hand possible.

Kraftform Plus – Series 300

The answer to almost every screw.

335/350/355/4 Screwdriver set Kraftform Plus Lasertip with holding function and 200 mm-long blades



Lasertip blades. "Take it easy" tool finder: colour coding according to profile and size stamp.

Application: Slotted, Phillips and Pozidriv screws

Content: 4-piece set

05347736002		
+	350 PH	1 x PH 2x200
+	355 PZ	1 x PZ 1x200; 1 x PZ 2x200
—	335	1 x 1,0x5,5x200

335/350/367/7 Rack screwdriver set Kraftform Plus Lasertip and rack

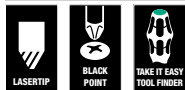

Lasertip round blades and rack. "Take it easy" tool finder: colour coding according to profile and size stamp.

Application: Slotted, cross, Phillips-Recess, Pozidriv and TORX® screws

Content: 7-piece set and rack in display carton

05320540001		
+	350 PH	1 x PH 2x100
+	355 PZ	1 x PZ 1x80; 1 x PZ 2x100
—	335	1 x 0,8x4,0x100
⊕	367 TORX®	1 x TX 15x80; 1 x TX 20x100; 1 x TX 25x100

367/7 TORX® HF Kraftform Plus screwdriver set with holding function and rack



Application: TORX®

Content: 7-piece set and rack in display carton

05223161001	
⊕	367 TORX® HF 1 x TX 8x60; 1 x TX 10x80; 1 x TX 15x80; 1 x TX 20x100; 1 x TX 25x100; 1 x TX 27x115; 1 x TX 30x115

367/6 TORX® HF Kraftform Plus screwdriver set with holding function and rack



Application: TORX®

Content: 6-piece set and rack in display carton

05028059001	
⊕	367 TORX® HF 1 x TX 10x80; 1 x TX 15x80; 1 x TX 20x100; 1 x TX 25x100; 1 x TX 30x115; 1 x TX 40x130

367/4 TORX® HF Kraftform Plus screwdriver set with holding function and 300 mm-long blades



Application: TORX® with holding function, extra long (300 mm) blade

Content: 4-piece set

05028074001	
⊕	367 TORX® HF 1 x TX 20x300; 1 x TX 25x300; 1 x TX 27x300; 1 x TX 30x300



367/6 Screwdriver set Krafftform Plus TORX® and rack



Application: TORX®

Content: 6-piece set with "Take it easy" tool finder: colour coding according to profile and size stamp and rack in display carton.

05028062001	
⊕	367 TORX® 1 x TX 10x80; 1 x TX 15x80; 1 x TX 20x100; 1 x TX 25x100; 1 x TX 30x115; 1 x TX 40x130

334/368/6 Screwdriver set and rack



Application: Slotted, Phillips and square-head screws

Content: 6-piece set with "Take it easy" tool finder: colour coding according to profile and size stamp and rack in display carton

05347778001	
⊕	350 PH 1 x PH 1x80; 1 x PH 2x100
⊖	334 1 x 1,2x6,5x150
⊞	335 1 x 0,8x4,0x100
⊚	368 1 x # 1x80; 1 x # 2x100

367/6 TORX® B0 Krafftform Plus screwdriver set and rack



Application: TORX® screws with safety pin (B0 = with bore hole)

Content: 6-piece set and rack in display carton

05138250001	
⊕	367 TORX® B0 1 x TX 10x80; 1 x TX 15x80; 1 x TX 20x100; 1 x TX 25x100; 1 x TX 30x115; 1 x TX 40x130

395 H0/7 SM Nutdriver set



Application: Hexagon headed bolts, screws and nuts

Content: 7-piece set in display carton

TIP: The hollow shaft enables seized screws or those on long threads to be tightened and loosened

05029510001	
⊕	395 H0 1 x 5,0x90; 1 x 5,5x90; 1 x 6,0x90; 1 x 7,0x90; 1 x 8,0x90; 1 x 10,0x90; 1 x 13,0x90

Kraftform Comfort Screwdrivers

The ergonomic introduction to convenient screwdriving.

Handle with Kraftform geometry and blade made from power bit material with Black Point tip for precise fit.

For all kinds of application.



The multi-component Kraftform handle for quick and low-exertion working.



The screw symbol and tip size identification markings on the handle make it easier to find the right screwdriver in the tool case, or at the workplace.

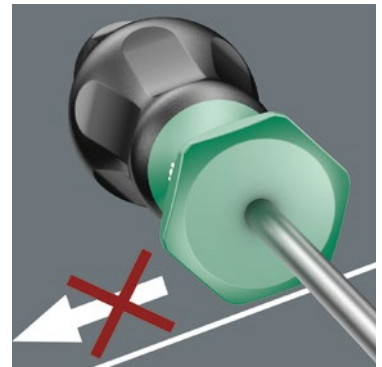

The hexagonal non-roll feature prevents any annoying rolling away.



The Wera Black Point tip and a refined hardening process ensure long service life of the tip, improved corrosion protection and an exact fit.

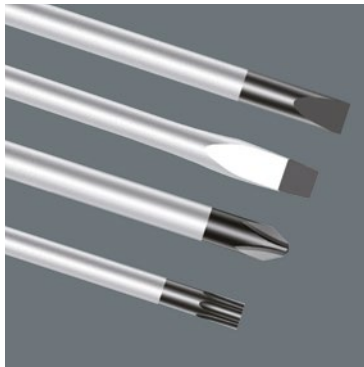

The bit material used for manufacturing is subjected to a specific Wera hardening process, and this ensures longer product service life.







Kraftform Comfort

Convenient, safe, good!

1335 Screwdriver for slotted screws









Application: Slotted screws
Blade: Round
Design: Chrome-plated, Black Point
Handle: Kraftform Comfort with non-roll feature, multi-component

	 mm	 mm	 mm	 mm	 mm	 mm	 mm
05031400001	0,4	2,0	60	81	2,5	$\frac{5}{64}$ "	$2\frac{3}{8}$ "
05031401001	0,4	2,5	75	81	2,5	$\frac{3}{32}$ "	3"
05031402001	0,5	3,0	80	81	3,0	$\frac{1}{8}$ "	$3\frac{1}{8}$ "
05031403001	0,5	3,0	150	81	3,0	$\frac{1}{8}$ "	6"
05031405001	0,6	3,5	100	81	3,5	$\frac{9}{64}$ "	4"
05031406001	0,6	3,5	125	81	3,5	$\frac{9}{64}$ "	5"
05031408001	0,8	4,0	100	98	4,0	$\frac{5}{32}$ "	4"
05031409001	0,8	4,0	150	98	4,0	$\frac{5}{32}$ "	6"
05031411001	0,8	4,0	300	98	4,0	$\frac{5}{32}$ "	12"
05031412001	1,0	5,5	125	98	5,5	$\frac{7}{32}$ "	5"
05031413001	1,0	5,5	150	98	5,5	$\frac{7}{32}$ "	6"
05031416001	1,2	6,0	100	105	6,0	$\frac{15}{64}$ "	4"

1334 Screwdriver for slotted screws







Application: Slotted screws
Blade: Round
Design: Chrome-plated, Black Point
Handle: Kraftform Comfort with non-roll feature, multi-component

	 mm	 mm	 mm	 mm	 mm	 mm	 mm
05031420001	0,8	5,0	100	98	$\frac{3}{16}$ "	4"	
05031421001	1,0	6,0	125	105	$\frac{15}{64}$ "	5"	
05031422001	1,2	6,5	150	105	$\frac{1}{4}$ "	6"	
05031424001	1,2	7,0	150	105	$\frac{9}{32}$ "	6"	
05031425001	1,2	8,0	175	112	$\frac{5}{16}$ "	7"	
05031426001	1,6	8,0	175	112	$\frac{5}{16}$ "	7"	
05031427001	1,6	10,0	200	112	$\frac{3}{8}$ "	8"	

1350 PH Screwdriver for Phillips screws







Application: Phillips screws
Blade: Round
Design: Chrome-plated, Black Point
Handle: Kraftform Comfort with non-roll feature, multi-component

		 mm	 mm	 mm	 mm
05031440001	PH 0	60	81	3,0	$2\frac{3}{8}$ "
05031441001	PH 1	80	98	4,5	$3\frac{1}{8}$ "
05031442001	PH 1	200	98	4,5	8"
05031444001	PH 2	100	105	6,0	4"
05031445001	PH 2	200	105	6,0	8"
05031447001	PH 3	150	112	8,0	6"

1355 PZ Screwdriver for Pozidriv screws



Application: Suitable for Pozidriv screws
Blade: Round
Design: Chrome-plated, Black Point
Handle: Kraftform Comfort with non-roll feature, multi-component

		 mm	 mm	 mm	 mm
05031460001	PZ 0	60	81	3,0	$2\frac{3}{8}$ "
05031461001	PZ 1	80	98	4,5	$3\frac{1}{8}$ "
05031463001	PZ 2	100	105	6,0	4"
05031466001	PZ 3	150	112	8,0	6"



Tip

1367 TORX® screwdriver for TORX® screws



- Application:** TORX® socket screws
- Blade:** Round
- Design:** Chrome-plated, Black Point
- Handle:** Kraffform Comfort with non-roll feature, multi-component

		 mm	 mm	 mm	 "
05031500001	TX 5	60	81	3,5	2 3/8"
05031501001	TX 6	60	81	3,5	2 3/8"
05031502001	TX 7	60	81	3,5	2 3/8"
05031503001	TX 8	60	81	3,5	2 3/8"
05031504001	TX 9	60	81	4,0	2 3/8"
05031505001	TX 10	80	81	4,0	3 1/8"
05031506001	TX 15	80	98	4,0	3 1/8"
05031507001	TX 20	100	98	4,5	4"
05031508001	TX 25	100	105	5,0	4"
05031509001	TX 27	115	105	5,5	4 9/16"
05031510001	TX 30	115	105	6,0	4 9/16"
05031511001	TX 40	130	112	7,0	5 3/16"
05031512001	TX 45	130	112	8,0	5 1/8"



The Wera Black Point tip



The Wera Black Point tip and a refined hardening process ensure long service life of the tip, improved corrosion protection and an exact fit.

The screw symbol



The screw symbol and tip size identification markings on the handle make it easier to find the right screwdriver in the tool case, or at the workplace.

Kraftform Comfort

Convenient, safe, good!

1334/6 Screwdriver set Kraftform Comfort



Application: Slotted and Phillips screws

Content: 6-piece set in display carton

05031551001	
+	1350 PH 1 x PH 1x80; 1 x PH 2x100
+	1335 1 x 0,5x3,0x80; 1 x 0,8x4,0x100; 1 x 1,0x5,5x125
+	1334 1 x 1,2x6,5x150

1335/1350/1355/6 Screwdriver set Kraftform Comfort



Application: Slotted, Phillips and Pozidriv screws

Content: 6-piece set in display carton

05031553001	
+	1350 PH 1 x PH 1x80; 1 x PH 2x100
+	1355 PZ 1 x PZ 1x80; 1 x PZ 2x100
+	1335 1 x 0,8x4,0x100; 1 x 1,0x5,5x125

1334/1355/6 Screwdriver set Kraftform Comfort



Application: Slotted and Pozidriv screws

Content: 6-piece set in display carton

05031552001	
+	1355 PZ 1 x PZ 1x80; 1 x PZ 2x100
+	1335 1 x 0,5x3,0x80; 1 x 0,8x4,0x100; 1 x 1,0x5,5x125
+	1334 1 x 1,2x6,5x150

1367/6 TORX® Screwdriver set Kraftform Comfort



Application: TORX® screws

Content: 6-piece set in display carton

05031554001	
+	1367 TORX® 1 x TX 10x80; 1 x TX 15x80; 1 x TX 20x100; 1 x TX 25x100; 1 x TX 30x115; 1 x TX 40x130



Screwdrivers with wooden handles

The traditional screwdriver with very specific product benefits.



Higher torque can be transferred by fitting an open-jaw or ring spanner over the hex bolster that is welded to the blade.



A double leather cap combined with the blade that extends right through the handle provide additional safety and reduce the danger of a splintering of the handle when struck with a hammer.

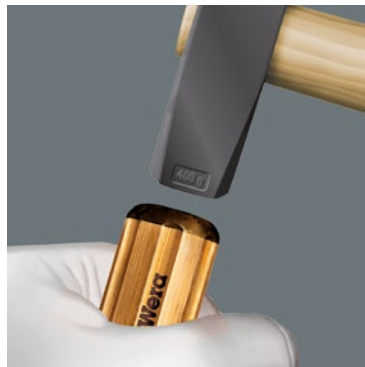

With pound-thru blade out of high quality bit material. As a result, loss-free transfer of power, even in the case of hammer blows. The material prevents any splintering or breakage of the blade.



The Wera Black Point tip and a refined hardening process ensure long service life of the tip, improved corrosion protection and an exact fit.









Wooden Handle Series

Traditionally good quality!

930 A Screwdriver for slotted screws







Application: Slotted screws
Blade: Round, hexagon bolster
Design: Chrome-plated, Black Point
Handle: Beech wood with leather cap

	 mm	 mm	 mm	 mm	 mm	 mm	 mm
05018005001	0,6	3,5	8	90	102	$\frac{9}{64}$ "	$3\frac{1}{2}$ "
05018010001	0,8	4,5	8	90	102	0,178"	$3\frac{1}{2}$ "
05018015001	1,0	5,5	8	100	102	$\frac{7}{32}$ "	4"
05018020001	1,2	7,0	10	125	111	$\frac{9}{32}$ "	5"
05018025001	1,6	9,0	13	175	126	$\frac{11}{32}$ "	7"
05018030001	1,6	10,0	13	175	126	$\frac{3}{8}$ "	7"
05018035001	2,0	12,0	13	200	126	$\frac{1}{2}$ "	8"
05018040001	2,5	14,0	16	250	140	$\frac{9}{16}$ "	10"

935 SPH Screwdriver for Phillips screws







Application: Phillips screws
Blade: Round, hexagon bolster
Design: Chrome-plated, Black Point
Handle: Beech wood with leather cap

	 mm	 mm	 mm	 mm	 mm
05018350001	PH 1	8	90	102	$3\frac{1}{2}$ "
05018352001	PH 2	10	100	111	4"
05018354001	PH 3	13	175	126	7"
05018355001	PH 4	16	200	140	8"

955 SPZ Screwdriver for Pozidriv screws





Application: Suitable for Pozidriv screws
Blade: Round, hexagon bolster
Design: Chrome-plated, Black Point
Handle: Beech wood with leather cap

	 mm	 mm	 mm	 mm	 mm
05023305001	PZ 1	8	90	102	$3\frac{1}{2}$ "
05023307001	PZ 2	10	100	111	4"
05023309001	PZ 3	13	175	126	7"

930/935/6 Screwdriver set





Application: Slotted and Phillips screws
Content: 6-piece set in display carton

		
05018251001		
	935 SPH	1 x PH 1x90; 1 x PH 2x100
	930 A	1 x 0,6x3,5x90; 1 x 0,8x4,5x90; 1 x 1,0x5,5x100; 1 x 1,2x7,0x125

930/955/6 Screwdriver set



Application: Slotted and Pozidriv screws
Content: 6-piece set in display carton

		
05137810001		
	955 SPZ	1 x PZ 1x90; 1 x PZ 2x100
	930 A	1 x 0,6x3,5x90; 1 x 0,8x4,5x90; 1 x 1,0x5,5x100; 1 x 1,2x7,0x125

Flagdriver Series

The right tool for every application



1267 A TORX® flagdriver for TORX® screws



Application: TORX® socket screws
Blade: Round
Design: BlackLaser surface
Handle: Multi-component

		mm	mm	mm	
05026350001	TX 6	33	62,0	3,0	1 19/64"
05026351001	TX 7	33	62,0	3,0	1 19/64"
05026352001	TX 8	40	69,0	3,0	1 37/64"
05026353001	TX 9	40	69,0	3,0	1 37/64"
05026354001	TX 10	40	69,0	3,0	1 37/64"

1267 B TORX® combination flagdriver for TORX® and hexagon socket screws



Application: TORX® and hexagon socket screws
Blade: Hexagon
Design: TORX® and hexagon, BlackLaser surface
Handle: Multi-component

		mm	mm	mm	
05026372001	TX 15	3,5	47	86,0	1 27/32"
05026373001	TX 15	4	47	86,0	1 27/32"
05026374001	TX 20	4	47	86,0	1 27/32"

1267 A TORX PLUS® flagdriver for TORX PLUS® screws



Application: TORX PLUS® socket screws
Blade: Round
Design: BlackLaser surface
Handle: Multi-component

		mm	mm	mm	
05026360001	6 IP	33	62,0	3,0	1 19/64"
05026361001	7 IP	33	62,0	3,0	1 19/64"
05026363001	9 IP	40	69,0	3,0	1 37/64"

1267 B TORX PLUS® combination flagdriver for TORX PLUS® and hexagon socket screws



Application: TORX PLUS® and hexagon socket screws
Blade: Hexagon
Design: TORX PLUS® and hexagon, BlackLaser surface
Handle: Multi-component

		mm	mm	mm	
05026382001	15 IP	3,5	47	86,0	1 27/32"

Accessories

Indispensable aids for screwdriving jobs

Wera Star Magnetizer/Demagnetizer



Application: Simply run the tool down the positive side of the Wera magnetiser/demagnetiser and the tool immediately becomes magnetised and is able to hold the screw securely on the blade. To demagnetise the tool, simply run it down one of the four negative sides.

	
05073403001	
Wera Star	1 x 48,0



Magnetising

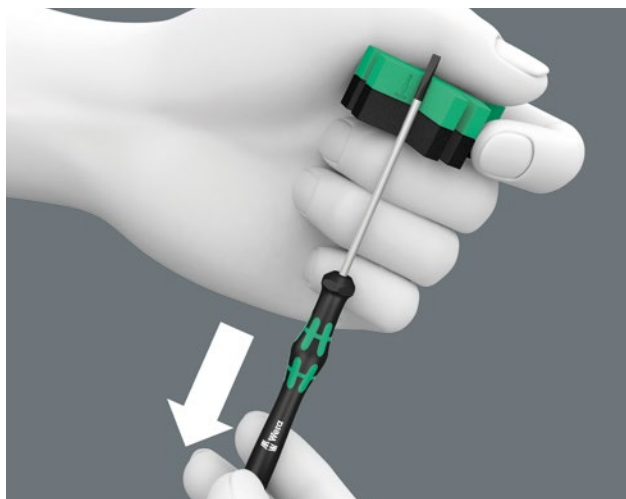



Demagnetising

1427 Awl



Handle: single-component

Blade: Extends through handle



			
	mm	mm	
05027405001	105	92	4 3/16"

1428 Reamer





Handle: single-component

Blade: Extends through handle

			
	mm	mm	
05027455001	107	92	4 9/32"

Rack for Kraftform Micro screwdrivers



		
	mm	mm
05134002001	190,0	80



Rack for Kraftform screwdrivers



	mm	mm
05134001001	190,0	50,0

1440/1442 Screw gripper set

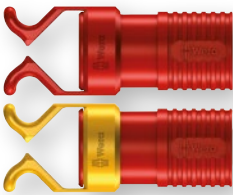

Application: Attachment with holding function for screws, holds all screw profiles and sizes securely on the tool, suitable for round and hexagon blades with a diameter from 4.5 mm to 6.0 mm and 6.0 mm to 8.5 mm

Design: Elastomer

05073680001		
	1440	1 x 4,5 - 6,0x41,0
	1442	1 x 6,0-8,5x41,0

1441 Screw gripper attachment for screwdriver blades, long bits and L-keys, with holding function for screws



Application: Attachment with holding function for screws, holds all screw profiles and sizes securely on the tool, suitable for round and hexagon blades with a diameter from 4.5 mm to 6.0 mm

Design: Elastomer

	mm	mm
05073681001	4,5-6,0	41,0

And this is how the gripper works:

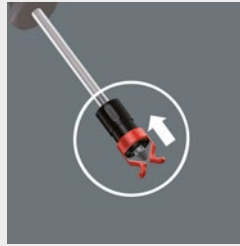

Push the screw gripper onto the tip of the screwdriver until the end of the blade protrudes from the rubber blade holder.

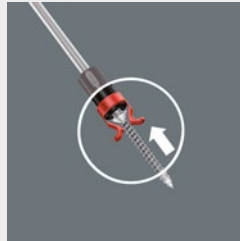

Attach the screw to the tip of the blade and secure it in the screw gripper.

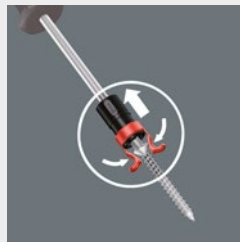

Pull the screw gripper towards the screwdriver handle until the two arms of the gripper sit against the head of the screw and are spread slightly apart. The Wera screw gripper releases the screw automatically after it has been fastened.

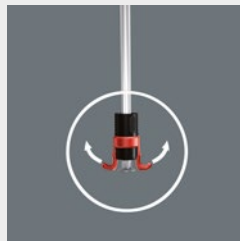

The two gripper arms spread further apart as they are pushed against the surface and automatically snap back when the head of the screw is countersunk.

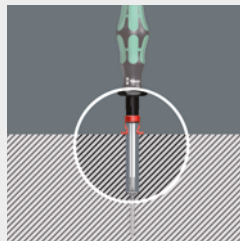

When fastening screws in blind holes the screw gripper is pushed back, making it possible to reach even deep-seated screws.



The screw gripper attachment can also be used with L-keys and long bits!

Kraftform Micro

Screwdriving jobs in electrical and precision engineering applications are often tedious and time-consuming.

We learned from users what is important for them: working speeds, torque, precision – and we then focused particularly on these issues.



The fast-turning zone just below the rotating cap allows rapid twisting.



The power zone has integrated soft zones near the blade tip to ensure high torque transfer for loosening or tightening screws without losing contact with the screw.



The precision zone directly above the blade gives the user a better feel for the right rotation angle during fine adjustment work.

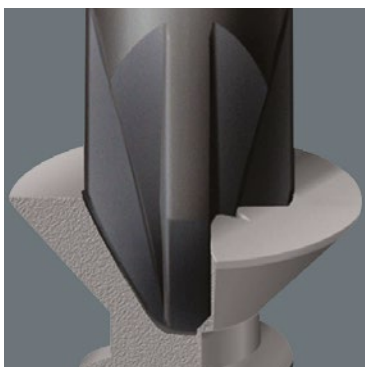
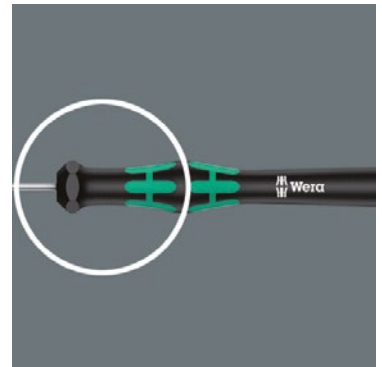

The Wera Black Point tip, as well as a refined hardening process, ensure long service life and enhanced corrosion protection.

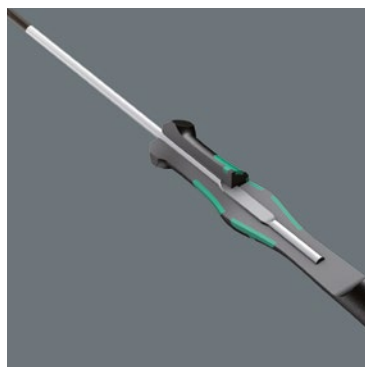

Multi-component screwdriver handle for ergonomic working.

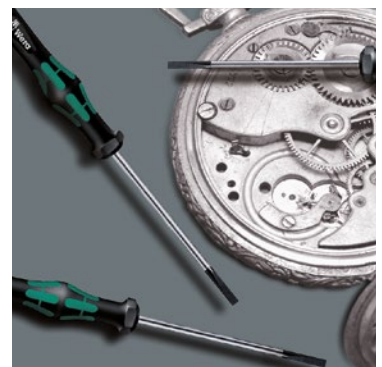

Indispensable for many users, including electronics technicians, opticians, precision engineers, jewellers, EDP hardware fitters and model-makers.



Series Kraftform Micro

The refined screwdriver for electronics technicians

2035 Screwdriver for slotted screws for electronic applications



Application: Slotted screws
Blade: Round
Design: Chrome-plated, Black Point
Handle: Kraftform Micro with non-roll feature and rotating cap, multi-component

	mm	mm	mm	mm	mm	mm	mm
05117990001	0,16	0,8	40	97	2,0	1/32"	1 9/16"
05117991001	0,18	1,0	40	97	2,0	0,04"	1 9/16"
05117992001	0,20	1,2	40	97	2,0	0,05"	1 9/16"
05118002001	0,23	1,5	40	97	2,0	1/16"	1 9/16"
05118003001	0,23	1,5	60	97	2,0	1/16"	2 3/8"
05118000001	0,25	1,2	40	97	2,0	0,05"	1 9/16"
05117993001	0,30	1,8	40	97	2,0	0,07"	1 9/16"
05118004001	0,30	1,8	60	97	2,0	0,07"	2 3/8"
05117997001	0,35	2,5	40	97	2,0	0,07"	1 9/16"
05118017001	0,30	2,0	50	97	2,0	0,07"	2"
05118005001	0,40	2,0	40	97	2,5	5/64"	1 9/16"
05118006001	0,40	2,0	60	97	2,5	5/64"	2 3/8"
05118007001	0,40	2,0	100	97	2,5	5/64"	4"
05117994001	0,40	2,5	50	97	2,5	3/32"	2"
05118008001	0,40	2,5	80	97	2,5	3/32"	3 1/8"
05117995001	0,50	3,0	50	97	3,0	1/8"	2"
05118010001	0,50	3,0	80	97	3,0	1/8"	3 1/8"
05118012001	0,60	3,5	80	97	4,0	9/64"	3 1/8"
05118014001	0,80	4,0	80	97	4,0	5/32"	3 1/8"

2055 PZ Screwdriver for Pozidriv screws for electronic applications



Application: Suitable for Pozidriv screws
Blade: Round
Design: Chrome-plated, Black Point
Handle: Kraftform Micro with non-roll feature and rotating cap, multi-component

	mm	mm	mm	mm	
05118030001	PZ 0	60	97	3,0	2 3/8"
05118032001	PZ 1	80	97	4,0	3 1/16"

2050 PH Screwdriver for Phillips screws for electronic applications



Application: Phillips screws
Blade: Round
Design: Chrome-plated, Black Point
Handle: Kraftform Micro with non-roll feature and rotating cap, multi-component

	mm	mm	mm	mm	
05345290001 ^{1) 2)}	PH 000	40	97	1,5/2,5	1 9/16"
05118019001 ^{1) 3)}	PH 00	40	97	1,8/2,5	1 9/16"
05118020001 ¹⁾	PH 00	60	97	2,5	2 3/8"
05118026001 ²⁾	PH 0	40	97	3,0	1 9/16"
05118022001 ²⁾	PH 0	60	97	3,0	2 3/8"
05118023001	PH 1	60	97	4,0	2 3/8"
05118024001	PH 1	80	97	4,0	3 1/8"

¹⁾ Optimised for Asian PH screws

²⁾ Size 0 modified according to JCS 0 (Japanese Camera Industrial Standard)

³⁾ On the output side, the blade is turned to a nominal length of 10 mm.

2067 TORX® HF screwdriver with holding function for electronic applications



Application: TORX® socket screws
Blade: Round
Design: Holding function for TORX® screws made according to Acument Global Technologies Inc. specifications, chrome-plated, Black Point
Handle: Kraftform Micro with non-roll feature and rotating cap, multi-component

	mm	mm	mm	mm	
05118180001	TX 4	40	97	2,5	1 9/16"
05118181001	TX 5	40	97	3,0	1 9/16"
05118182001	TX 6	40	97	3,0	1 9/16"
05118183001	TX 7	60	97	3,0	2 3/8"
05118184001	TX 8	60	97	3,0	2 3/8"
05118185001	TX 9	60	97	4,0	2 3/8"
05118186001	TX 10	60	97	4,0	2 3/8"



Tip

2067 TORX® screwdriver for TORX® screws for electronic applications



- Application:** TORX® socket screws
- Blade:** Round
- Design:** Chrome-plated, Black Point
- Handle:** Krafftform Micro with non-roll feature and rotating cap, multi-component

		 mm	 mm	 mm	 "
05118035001	TX 1	40	97	2,0	1 9/16"
05118036001	TX 2	40	97	2,0	1 9/16"
05118037001	TX 3	40	97	2,0	1 9/16"
05118039001	TX 4	40	97	2,5	1 9/16"
05118040001	TX 5	40	97	3,0	1 9/16"
05118042001	TX 6	40	97	3,0	1 9/16"

2067 TORX® BO screwdriver for tamper-proof TORX® screws for electronic applications



- Application:** TORX® socket screws with safety pin (BO = with bore hole)
- Blade:** Round
- Design:** Bore hole in TORX® section, chrome-plated, Black Point
- Handle:** Krafftform Micro with non-roll feature and rotating cap, multi-component

		 mm	 mm	 mm	 "
05118044001	TX 7	60	97	3,0	1 9/16"
05118046001	TX 8	60	97	3,0	2 3/8"
05118048001	TX 9	60	97	4,0	2 3/8"
05118050001	TX 10	60	97	4,0	2 3/8"
05118052001	TX 15	60	97	4,0	2 3/8"
05118054001	TX 20	60	97	4,0	2 3/8"

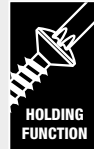

How can I hold my TORX® screw securely on the screwdriver?



The electronic TORX® screwdriver with holding function (HF) literally presses the screw onto the screwdriver. The conical driving flanks that taper toward the tip of the tool, the optimised flank base and the ideal engage depth hold the screw securely on the blade.

How to perform precision screwdriving jobs quickly whilst still applying the required degree of force?

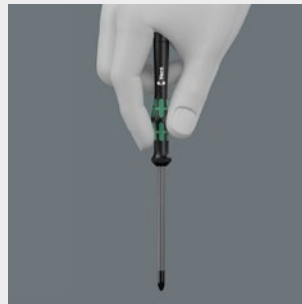

The Krafftform Micro, with its three zones and their specific arrangement, satisfies these requirements perfectly. The free-turning cap that provides support for the hand works with these advantages, enabling quick and easy precision work.

Series Kraftform Micro

The refined screwdriver for electronics technicians

2067 IPR TORX PLUS® screwdriver for electronic applications



Application: TORX PLUS® IPR socket screws
Blade: Round
Design: Chrome-plated, Black Point
Handle: Kraftform Micro with non-roll feature and rotating cap, multi-component

	mm	mm	mm	mm	mm
05030160001	1 IPR	44	97	2,0	1 47/64"

2054 Screwdriver for hexagon socket screws for electronic applications



Application: Hexagon socket screws
Blade: Round
Design: Hex-Plus, chrome-plated, Black Point
Handle: Kraftform Micro with non-roll feature and rotating cap, multi-component

	mm	mm	mm	mm	mm	
05118060001	0,7	40	97	3,0	1 9/16"	
05118062001	0,9	40	97	3,0	1 9/16"	
05118064001	1,3	40	97	3,0	1 9/16"	
05118066001	1,5	60	97	3,0	2 3/8"	
05118068001	2	60	97	3,0	2 3/8"	
05118070001	2,5	60	97	4,0	2 3/8"	
05118072001	3,0	60	97	4,0	2 3/8"	
05345284001	-	0,028"	40	97	3,0	1 9/16"
05345285001	-	0,035"	40	97	3,0	1 9/16"
05118074001	-	0,05"	40	97	3,0	1 9/16"
05118076001	-	1/16"	60	97	3,0	2 3/8"
05118078001	-	5/64"	60	97	3,0	2 3/8"
05118080001	-	3/32"	60	97	4,0	2 3/8"
05118082001	-	7/64"	60	97	4,0	2 3/8"
05118075001	-	1/8"	60	97	4,0	2 3/8"

2052 Ball end hexagon screwdriver for electronic applications



Application: Hexagon socket screws
Blade: Round
Design: Hexagon ball end, chrome-plated, Black Point
Handle: Kraftform Micro with non-roll feature and rotating cap, multi-component

	mm	mm	mm	mm	mm	
05118089001	1,3	60	97	3,0	2 3/8"	
05118090001	1,5	60	97	3,0	2 3/8"	
05118092001	2,0	60	97	3,0	2 3/8"	
05118094001	2,5	60	97	4,0	2 3/8"	
05118096001	3,0	60	97	4,0	2 3/8"	
05118098001	-	1/16"	60	97	3,0	2 3/8"
05118100001	-	5/64"	60	97	3,0	2 3/8"
05118102001	-	3/32"	60	97	3,0	2 3/8"
05118106001	-	7/64"	60	97	4,0	2 3/8"
05118103001	-	1/8"	60	97	4,0	2 3/8"

2072 Kraftform Micro screwdriver for Microstix® screws



Application: Microstix® socket screws
Blade: Round
Design: Chrome-plated, Black Point
Handle: Kraftform Micro with non-roll feature and rotating cap, multi-component







	mm	mm	mm	mm	mm
05118145001	m	40	97	2,5	1 9/16"



2069 Nutdriver for electronic applications







Application: Hexagon headed bolts, screws and nuts
Blade: Round
Design: Chrome-plated
Handle: Kraftform Micro with non-roll feature and rotating cap, multi-component

	 mm	 mm	 mm	 mm	 mm	 mm
05118108001	1,5		60	97	5,7	2 ³ / ₈ "
05118109001	1,8		60	97	5,7	2 ³ / ₈ "
05118110001	2,0		60	97	5,7	2 ³ / ₈ "
05118112001	2,5		60	97	5,7	2 ³ / ₈ "
05118114001	3,0		60	97	5,7	2 ³ / ₈ "
05118116001	3,2		60	97	5,7	2 ³ / ₈ "
05118118001	3,5		60	97	5,7	2 ³ / ₈ "
05118120001	4,0		60	97	5,7	2 ³ / ₈ "
05118122001	4,5		60	97	6,4	2 ³ / ₈ "
05118124001	5,0		60	97	7,0	2 ³ / ₈ "
05118126001	5,5		60	97	7,8	2 ³ / ₈ "
05345281001	6,0		60	97	8,5	2 ³ / ₈ "
05118128001	-	³ / ₃₂ "	60	97	5,7	2 ³ / ₈ "
05118130001	-	⁷ / ₆₄ "	60	97	5,7	2 ³ / ₈ "
05118132001	-	¹ / ₈ "	60	97	5,7	2 ³ / ₈ "
05118134001	-	⁹ / ₆₄ "	60	97	5,7	2 ³ / ₈ "
05118136001	-	⁵ / ₃₂ "	60	97	5,7	2 ³ / ₈ "
05118135001	-	³ / ₁₆ "	60	97	6,6	2 ³ / ₈ "
05118137001	-	⁷ / ₃₂ "	60	97	7,8	2 ³ / ₈ "
05345282001	-	¹ / ₄ "	60	97	9,0	2 ³ / ₈ "

1429 Chip lifter



Application: Lifting tightly-fitting parts from circuit boards after desoldering
Blade: Round
Design: Chrome-plated
Handle: Kraftform Micro with non-roll feature and rotating cap, multi-component

	 mm	 mm	 mm	 mm
05027456001	1,0	3,5	50	97

Tip

How to hold any screw securely on the screwdriver?



With the Wera magnetiser/demagnetiser: simply run the tool down the positive side of the Wera magnetiser/demagnetiser and the tool immediately becomes magnetised and is able to hold the screw securely on the blade.

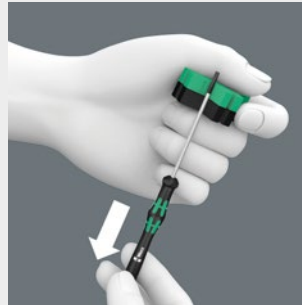

To demagnetise the tool, simply run it down one of the four negative sides. See page 62.



Hexagon ball tip



The spherical drive profile means that it is possible to swivel the axis of the tool to that of the screw, and therefore enable angled, "around-the-corner" screw-driving jobs.

Series Kraftform Micro

The refined screwdriver for electronics technicians

1013 Kraftform Micro bitholding screwdriver

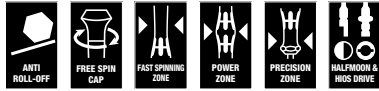

Application: Suitable for bits with 4 mm Halfmoon drive (and Wera Serie 9) and 4 mm HIOS drive (and Wera Series 21)

Design: With quick-release chuck for rapid bit change

Handle: Kraftform Micro with non-roll feature and rotating cap, multi-component

	mm	mm	"
05051276001	23	97	1"

Kraftform Micro 12 Electronics 1 Screwdriver set for electronic applications



Application: Slotted, Phillips, TORX® BO, TORX PLUS® IPR, Microstix® screws and hexagon headed bolts, screws and nuts. 1 remover.

Content: 12-piece set, in a belt pouch

Kraftform Micro 12 Universal 1 Screwdriver set for electronic applications



Application: Slotted and Phillips screws, TORX® socket screws, and Hexagon socket screws

Content: 12-piece set, in a belt pouch

05073677001		
	2050 PH Micro	1 x PH 000x40 ¹⁾ ; 1 x PH 00x40 ¹⁾ ; 1 x PH 0x40 ²⁾
	2067 TORX® BO Micro	1 x TX 8x60; 1 x TX 10x60
	2067 IPR Micro	1 x 1 IPR x 44
	2035 Micro	1 x 0,23x1,5x40; 1 x 0,35x2,5x40
	2069 Micro	1 x 2,5x60; 1 x 3,0x60
	2072	1 x mx40
	1429	1 x 1,0x3,5x50

¹⁾ Optimised for Asian PH screws

²⁾ Size 0 modified according to JCIS 0 (Japanese Camera Industrial Standard)

05073675001		
	2050 PH Micro	1 x PH 00x60 ¹⁾ ; 1 x PH 0x60 ²⁾
	2067 TORX® HF	1 x TX 5x40; 1 x TX 6x40
	2035 Micro	1 x 0,23x1,5x40; 1 x 0,30x1,8x60; 1 x 0,40x2,0x60; 1 x 0,40x2,5x80; 1 x 0,50x3,0x80
	2054 Micro	1 x 0,9x40; 1 x 1,5x60; 1 x 2x60

¹⁾ Optimised for Asian PH screws

²⁾ Size 0 modified according to JCIS 0 (Japanese Camera Industrial Standard)



Kraftform Kompakt Micro 11 Electronics 1



11-piece set
Pouch with 44 mm bits
1 Kraftform Micro bitholding screwdriver 1013

05073676001	
1013	1 x 97
Kraftform Micro	
851/9 C	1 x PH 000x44 ¹⁾ ; 1 x PH 00x44 ¹⁾ ; 1 x PH 0x44 ²⁾
867/9 C	1 x TX 8x44
TORX®	
867/9 C TORX PLUS®	1 x 3 IPx44
867/9 IPR	1 x 1 IPRx44
TORX® PLUS	
800/9 C	1 x 0,35x2,5x44
872/9	1 x mx44
869/9	1 x 2,5x44,0; 1 x 3,0x44,0

¹⁾ Optimised for Asian PH screws
²⁾ Size 0 modified according to JCIS 0 (Japanese Camera Industrial Standard)

Kraftform Kompakt Micro 11 Universal 1



11-piece set
Pouch with 44 mm bits
1 Kraftform Micro bitholding screwdriver 1013

05135938001	
1013	1 x 97
Kraftform Micro	
851/9 C	1 x PH 00x44 ¹⁾ ; 1 x PH 0x44 ²⁾ ; 1 x PH 1x44 ¹⁾
840/9 C	1 x 1,5x44; 1 x 2,0x44
800/9 C	1 x 0,23x1,5x44; 1 x 0,40x2,0x44; 1 x 0,50x3,0x44
867/9 C	1 x TX 5x44; 1 x TX 6x44
TORX®	

¹⁾ Optimised for Asian PH screws
²⁾ Size 0 modified according to JCIS 0 (Japanese Camera Industrial Standard)

2035/6 A Screwdriver set and rack for electronic applications



Application: Slotted and Phillips screws
Content: 6-piece set and rack in display carton

05118150001	
2050 PH Micro	1 x PH 00x60 ¹⁾ ; 1 x PH 0x60 ²⁾
2035 Micro	1 x 0,30x1,8x60; 1 x 0,40x2,0x60; 1 x 0,40x2,5x80; 1 x 0,50x3,0x80

¹⁾ Optimised for Asian PH screws
²⁾ Size 0 modified according to JCIS 0 (Japanese Camera Industrial Standard)

Series Kraftform Micro

The refined screwdriver for electronics technicians

2035/6 B Screwdriver set and rack for electronic applications



Application: Slotted and Phillips screws
Content: 6-piece set and rack in display carton

05118152001	
	2050 PH Micro 1 x PH 0x60 ¹⁾ ; 1 x PH 1x80
	2035 Micro 1 x 0,40x2,5x80; 1 x 0,50x3,0x80; 1 x 0,60x3,5x80; 1 x 0,80x4,0x80

¹⁾ Size 0 modified according to JCIS 0 (Japanese Camera Industrial Standard)

2050/6 Screwdriver set and rack for electronic applications



Application: Slotted, Phillips, TORX PLUS® IPR and Microstix® screws
Content: 6-piece set and rack in display carton

05030181001	
	2050 PH Micro 1 x PH 000x40 ¹⁾ ; 1 x PH 00x40 ¹⁾ ; 1 x PH 0x40 ²⁾
	2067 IPR 1 x 1 IPR x 44
	Micro
	2072 1 x mx40
	2035 Micro 1 x 0,35x2,5x40

¹⁾ Optimised for Asian PH screws

²⁾ Size 0 modified according to JCIS 0 (Japanese Camera Industrial Standard)

2052/6 Hexagon screwdriver set and rack for electronic applications



Application: Ball end for hexagon socket screws
Content: 6-piece set and rack in display carton

05118156001	
	2052 Micro 1 x 1,5x60; 1 x 2,0x60; 1 x 2,5x60; 1 x 3,0x60
	2054 Micro 1 x 0,9x40; 1 x 1,3x40



2067/6 TORX® BO screwdriver set and rack for electronic applications



Application: TORX® socket screws with safety pin (BO = with bore hole)
Content: 6-piece set and rack in display carton

05118154001	
	2067 TORX® BO Micro 1 x TX 7x60; 1 x TX 8x60; 1 x TX 9x60; 1 x TX 10x60; 1 x TX 15x60; 1 x TX 20x60

2069/6 Screwdriver set and rack for electronic applications



Application: Hexagon headed bolts, screws and nuts
Content: 6-piece set and rack in display carton

05118158001	
	2069 Micro 1 x 2,0x60; 1 x 2,5x60; 1 x 3,0x60; 1 x 3,5x60; 1 x 4,0x60; 1 x 5,0x60



Screwdrivers with T-handle

The T-handle is useful whenever higher tightening or loosening torque need to be applied.

The exclusive use of hard material in combination with the large contact surface area in the hand ensures an efficient, positive transfer of power.



The ergonomic design of the T-handle fills the palm of the hand. The fingers rest in the soft, rounded recess, and the whole hand is in contact with the handle – so there is no friction loss between the hand and handle.

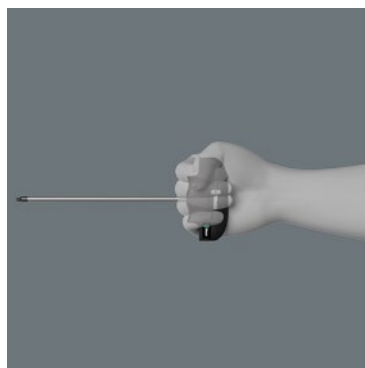

By using the blade as an extension of your lower arm you can transfer particularly high torque.

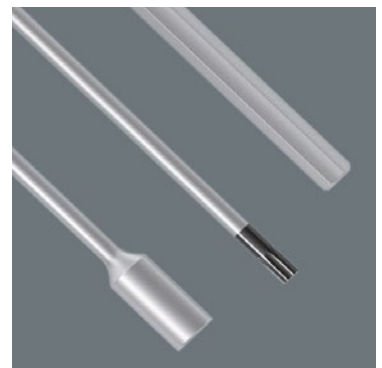

The blades are made for superior wear resistance and robustness.







Series 400 T-Handle

Ideal for high torque

454 T-handle hexdriver







Application: Hexagon socket screws
Blade: Hexagon
Design: Hex-Plus, chamfered, chrome-plated
Handle: T-handle, single-component

		 mm	 mm	 mm	 "
05013300001	2	100	27	61	4"
05013301001	2	200	27	61	8"
05013302001	2,5	100	27	61	4"
05013303001	2,5	200	27	61	8"
05013304001	3	100	33	70	4"
05013305001	3	150	33	70	6"
05013330001	3	200	33	70	8"
05013331001	3	350	33	70	14"
05013332001	4	100	33	70	4"
05013306001	4	150	33	70	6"
05013307001	4	200	33	70	8"
05013333001	4	350	33	70	14"
05013334001	5	100	44	87	4"
05013308001	5	150	44	87	6"
05013309001	5	200	44	87	8"
05013335001	5	350	44	87	18"
05013337001	6	100	44	87	4"
05013338001	6	150	44	87	6"
05013310001	6	200	44	87	8"
05013339001	6	350	44	87	14"
05013311001	7	200	44	87	8"
05013341001	8	150	44	87	6"
05013312001	8	200	44	87	8"
05013314001	10	200	44	87	8"

454 T-handle hexdriver, imperial









Application: Hexagon socket screws
Blade: Hexagon
Design: Hex-Plus, chamfered, BlackLaser surface
Handle: T-handle, single-component

		 mm	 mm	 mm	 "
05344536001	$\frac{3}{32}$ "	100	27	61	4"
05344537001	$\frac{7}{64}$ "	100	27	61	4"
05344538001	$\frac{1}{8}$ "	100	33	70	4"
05344546001	$\frac{9}{64}$ "	150	33	70	6"
05344545001	$\frac{5}{32}$ "	150	33	70	6"
05344544001	$\frac{3}{16}$ "	150	44	87	6"
05344543001	$\frac{7}{32}$ "	150	44	87	6"
05344542001	$\frac{1}{4}$ "	200	44	87	8"
05344541001	$\frac{5}{16}$ "	200	44	87	8"
05344540001	$\frac{3}{8}$ "	200	44	87	8"

467 T-handle TORX® driver



Application: TORX® screws
Blade: Round
Design: Chrome-plated, Black Point
Handle: T-handle, single-component

		 mm	 mm	 mm	 "	 mm
05013350001	TX 6	100	27	61	4"	3,0
05013352001	TX 7	100	27	61	4"	3,0
05013354001	TX 8	100	27	61	4"	3,5
05013356001	TX 9	100	27	61	4"	3,5
05013358001	TX 10	100	27	61	4"	4,0
05013360001	TX 15	100	33	70	4"	4,0
05013362001	TX 20	100	33	70	4"	4,5
05013364001	TX 20	200	33	70	8"	4,5
05013366001	TX 25	100	33	70	4"	5,0
05013368001	TX 25	200	33	70	8"	5,0
05013370001	TX 27	200	44	87	8"	6,0
05013372001	TX 30	200	44	87	8"	6,0
05013374001	TX 40	200	44	87	8"	8,0
05013376001	TX 45	200	44	87	8"	9,0



495 T-handle nutspinner



Application: Hexagon headed bolts, screws and nuts
Blade: Round
Design: Hexagonal, chrome-plated
Handle: T-handle, single-component

		mm	mm	mm	mm	mm	mm
05013400001	5	230	33	70	9"		8,1
05013399001	5,5	230	33	70	9"		8,1
05013401001	6	230	33	70	9"		9,1
05013402001	7	230	44	87	9"		11,0
05013403001	8	230	44	87	9"		12,1
05013404001	9	230	44	87	9"		13,1
05013405001	10	230	44	87	9"		14,1
05013407001	11	230	44	87	9"		16,0
05013409001	12	230	44	87	9"		17,1
05013411001	13	230	44	87	9"		18,1

489 R T-handle Rapidaptor



Application: Suitable for 1/4" DIN ISO 1173-C 6,3 and E 6,3 hexagon insert bits and Wera Series 1 and 4

Drive: 1/4" hexagon with Rapidaptor rapid-in, rapid-out, rapid-spin, chuck-all and single-hand technology, magnetic

Handle: T-handle, multi-component

		mm	mm	mm	mm	mm
05013390001	1/4"	45	44	87	1 25/32"	

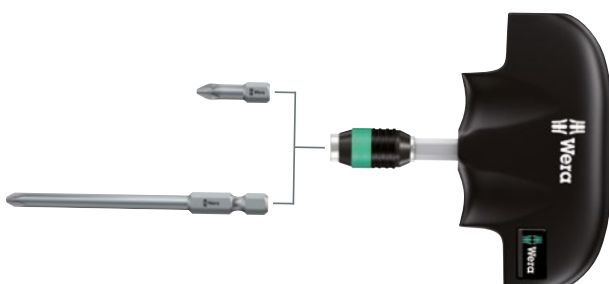

Rapidaptor

Rapid-in and self-lock



The bit can be pushed into the adaptor without moving the sleeve. The lock is activated automatically as soon as the bit is applied to the screw. Bits are held securely and wobble-free.

Rapid-out



Simply push the sleeve forward to change the bit. The spring mechanism lifts the bit off the magnet and unlocks the tool. The bit can be easily removed. The rapid-out function makes it easy to remove even the smallest bits without extra tools.

Chuck-all

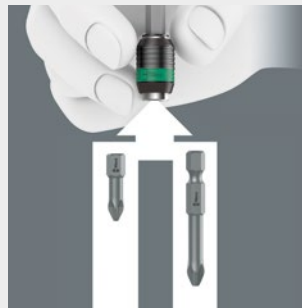

The Rapidaptor quick-release chucks hold 1/4" DIN ISO 1173-C 6,3 and E 6,3 as well as Wera series 1 and 4 bits.

Single-hand function



Every function of the Rapidaptor quick-release chuck, such as inserting or releasing bits, can be carried out with one hand. This is faster, more economical and more ergonomic. There are no unnecessary manoeuvres.

ESD Tools

When doing screwdriving jobs on electronic components (like e.g. smartphones and tablet PCs), there should be no electrostatic discharge as this could cause malfunctions and a complete failure.

Therefore, tools that are secure against electrostatic discharge are indispensable.



The requirements for ESD-safe screwdrivers are specified in the European standard DIN EN 61340-5-1. This standard also includes a handle that has to be out of a defined conductive material. The Wera products in the ESD series satisfy these standards and the even more stringent requirements demanded by some technology companies.

The electric surface resistance of the Wera ESD material is $\leq 10^9$ ohm. This securely protects components against electrostatic energy and associated damage.

Wera Black Point tips and a refined hardening process ensure long service life of the tip, improved corrosion protection and an exact fit.

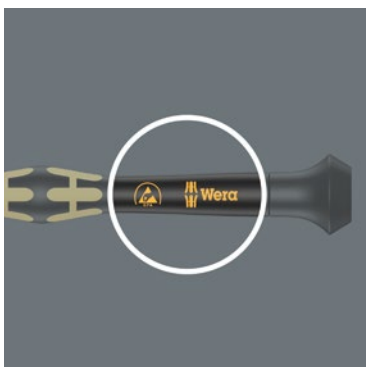
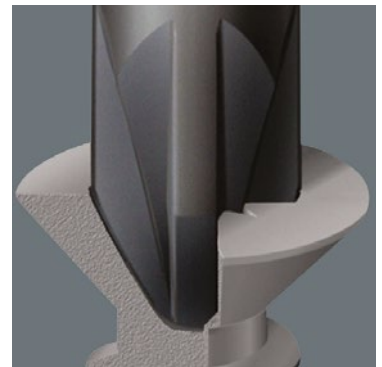

The fast-turning zone just below the rotating allows rapid twisting.

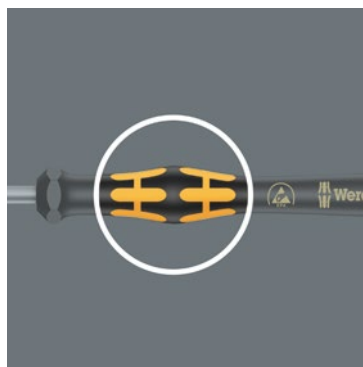

The power zone has integrated soft zones near the blade tip to ensure high torque transfer for loosening or tightening screws without losing contact with the screw.

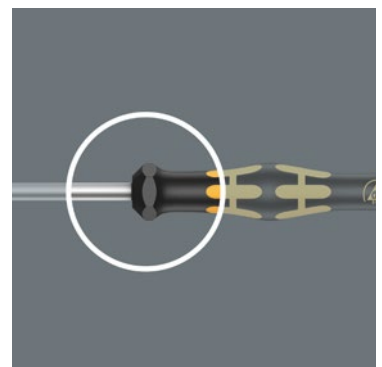

The precision zone directly above the blade gives the user a better feel for the right rotation angle during fine adjustment work.

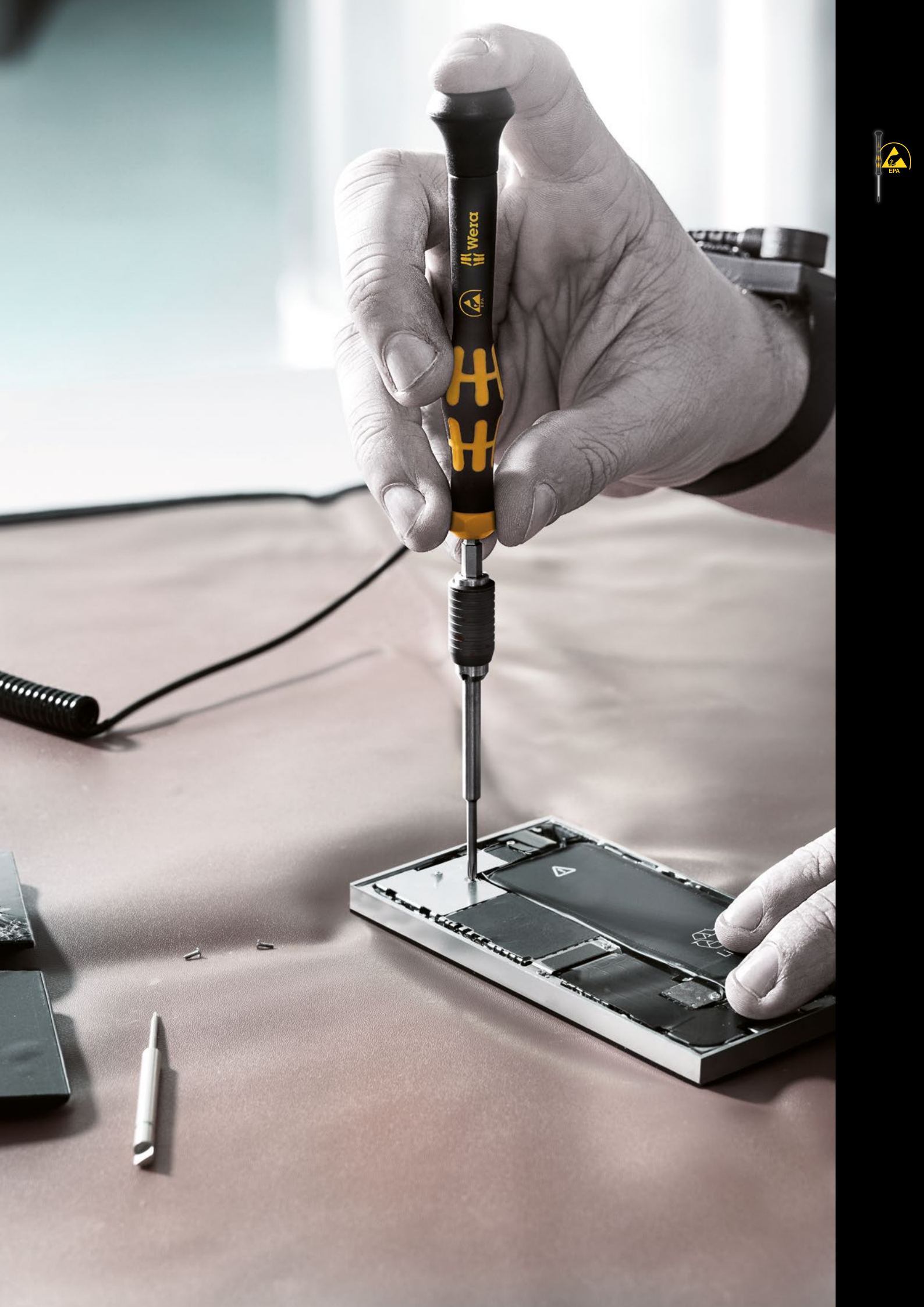







ESD Series

ESD-safe tools

1578 A Kraftform Micro screwdriver for slotted screws







Application: Slotted screws
Blade: Round
Design: Chrome-plated, Black Point
Handle: Kraftform Micro with non-roll feature and rotating cap, multi-component

							
	mm	mm	mm	mm	mm	"	"
05030101001	0,23	1,5	40	97	2,5	1/16"	1 9/16"
05030100001	0,25	1,2	40	97	2,5	0,05"	1 9/16"
05030102001	0,30	1,8	60	97	2,5	0,07"	2 3/8"
05030108001	0,35	2,5	40	97	2,5	3/32"	1 9/16"
05030103001	0,40	2,0	60	97	2,5	5/64"	2 3/8"
05030104001	0,40	2,5	80	97	2,5	3/32"	3 1/8"
05030105001	0,50	3,0	80	97	3,0	1/8"	3 1/8"
05030106001	0,60	3,5	80	97	4,0	9/64"	3 1/8"
05030107001	0,80	4,0	80	97	4,0	5/32"	3 1/8"

1550 PH Kraftform Micro screwdriver for Phillips screws



Application: Phillips screws
Blade: Round
Design: Chrome-plated, Black Point
Handle: Kraftform Micro with non-roll feature and rotating cap, multi-component

					
		mm	mm	mm	"
05030117001 ¹⁾ 3)	PH 000	40	97	1,5/2,5	1 9/16"
05030118001 ¹⁾ 3)	PH 00	40	97	1,8/2,5	1 9/16"
05030110001 ³⁾	PH 00	60	97	1,8/2,5	2 3/8"
05030119001	PH 0	40	97	3,0	1 9/16"
05030111001 ²⁾	PH 0	60	97	3,0	2 3/8"
05030112001	PH 1	80	97	4,0	3 1/8"

¹⁾ Optimised for Asian PH screws





²⁾ Size 0 modified according to JCIS 0 (Japanese Camera Industrial Standard)

³⁾ On the output side, the blade is turned to a nominal length of 10 mm.

1555 PZ Kraftform Micro screwdriver for Pozidriv screws







Application: Suitable for Pozidriv screws
Blade: Round
Design: Chrome-plated, Black Point
Handle: Kraftform Micro with non-roll feature and rotating cap, multi-component

					
		mm	mm	mm	"
05030115001	PZ 0	60	97	3,0	2 3/8"
05030116001	PZ 1	80	97	4,0	3 1/8"

1567 TORX® HF Kraftform Micro screwdriver with holding function for TORX® screws



Application: TORX® socket screws
Blade: Round
Design: Holding function for TORX® screws made according to Acument Intellectual Properties specifications, chrome-plated, Black Point
Handle: Kraftform Micro with non-roll feature and rotating cap, multi-component

					
		mm	mm	mm	"
05030400001	TX 4	40	97	2,5	1 9/16"
05030401001	TX 5	40	97	3,0	1 9/16"
05030402001	TX 6	40	97	3,0	1 9/16"
05030403001	TX 7	60	97	3,0	2 3/8"
05030404001	TX 8	60	97	3,0	2 3/8"
05030405001	TX 9	60	97	4,0	2 3/8"
05030406001	TX 10	60	97	4,0	2 3/8"



Tip

1567 TORX® Kraftform Micro screwdriver for TORX® screws



Application: TORX® socket screws
Blade: Round
Design: Chrome-plated, Black Point
Handle: Kraftform Micro with non-roll feature and rotating cap, multi-component

		mm	mm	mm	"
05030120001	TX 4	40	97	2,5	1 9/16"
05030121001	TX 5	40	97	3,0	1 9/16"
05030122001	TX 6	40	97	3,0	1 9/16"

1567 TORX® BO Screwdriver for tamper-proof TORX® screws



Application: TORX® socket screws with safety pin (BO = with bore hole)
Blade: Round
Design: Bore hole in TORX® section, chrome-plated, Black Point
Handle: Kraftform with non-roll feature, single-component

		mm	mm	mm	"
05030131001	TX 10	80	81	4,0	3 1/8"
05030127001	TX 15	80	98	4,0	3 1/8"
05030128001	TX 20	100	98	4,5	4"
05030129001	TX 25	100	98	5,0	4"
05030130001	TX 30	115	98	6,0	4 9/16"

1567 IPR TORX PLUS® screwdriver for electronic applications



Application: TORX PLUS® IPR socket screws
Blade: Round
Design: Chrome-plated, Black Point
Handle: Kraftform Micro with non-roll feature and rotating cap, multi-component

		mm	mm	mm	"
05030135001	1 IPR	40	97	2,0	1 9/16"

Rotating cap and fast-turning zone

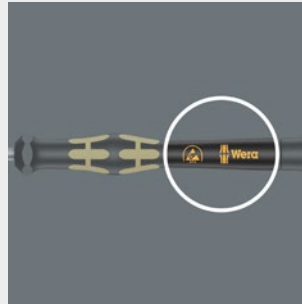

The fast-turning zone just below the rotating cap allow rapid twisting. This makes time-consuming grip adjustments as with other conventional precision screwdrivers unnecessary.

The power zone

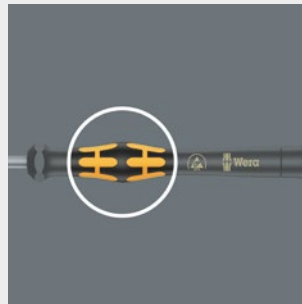

The power zone has integrated soft zones near the blade tip to ensure high torque transfer for loosening or tightening screws without losing contact with the screw.

The precision zone

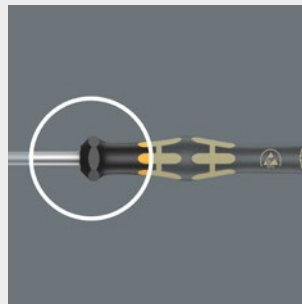

The precision zone directly above the blade gives the user a better feel for the right rotation angle during fine adjustment work.

ESD Series

ESD-safe tools

1572 ESD Krafftform Micro screwdriver for Microstix® screws



Application: Microstix® socket screws
Blade: Round
Design: Chrome-plated, Black Point
Handle: Krafftform Micro with non-roll feature and rotating cap, multi-component

		mm	mm	mm	"
05030080001	m	40	97	2,5	1 9/16"
05030081001	00	40	97	2,5	1 9/16"
05030082001	F	40	97	2,5	1 9/16"
05030083001	0	40	97	2,5	1 9/16"
05030084001	1	40	97	2,5	1 9/16"

1569 ESD Nutdriver



Application: Hexagon headed bolts, screws and nuts
Blade: Round
Design: Chrome-plated
Handle: Krafftform Micro with non-roll feature and rotating cap, multi-component

		mm	mm	mm	"
05030410001	1,5	60	97	5,7	2 3/8"
05030411001	1,8	60	97	5,7	2 3/8"
05030412001	2,0	60	97	5,7	2 3/8"
05030413001	2,5	60	97	5,7	2 3/8"
05030414001	3,0	60	97	5,7	2 3/8"
05030415001	3,2	60	97	5,7	2 3/8"
05030416001	3,5	60	97	5,7	2 3/8"
05030417001	4,0	60	97	5,7	2 3/8"
05030418001	4,5	60	97	6,4	2 3/8"
05030150001	5,0	60	97	7,0	2 3/8"
05030151001	5,5	60	97	7,8	2 3/8"

1578 A/6 ESD Screwdriver set and rack for electronic applications



Application: Slotted and Phillips screws
Content: 6-piece set and rack in display carton

05030170001	
	1550 PH Micro 1 x PH 0x60; 1 x PH 1x80
	1578 A Micro 1 x 0,23x1,5x40; 1 x 0,25x1,2x40; 1 x 0,30x1,8x60; 1 x 0,40x2,5x80

1550/6 ESD Screwdriver set and rack for electronic applications



Application: Slotted, Phillips and Microstix® screws
Content: 6-piece set and rack in display carton

05030180001	
	1550 PH Micro 1 x PH 000x40 ¹⁾ ; 1 x PH 00x40 ¹⁾ ; 1 x PH 0x40
	1578 A Micro 1 x 0,25x1,2x40; 1 x 0,35x2,5x40
	1572 ESD 1 x mx40

¹⁾ Optimised for Asian PH screws



1013 Kraffform Micro ESD bitholding screwdriver



Application: Suitable for bits with 4 mm Halfmoon drive (and Wera Serie 9) and 4 mm HIOS drive (and Wera Series 21)

Design: With quick-release chuck for rapid bit change

Handle: Kraffform Micro with non-roll feature and rotating cap, multi-component

	 mm	 mm	 "
05300004001	23	97	1"



816 R ESD bitholding screwdriver, non-magnetic



Application: Suitable for 1/4" DIN ISO 1173-C and E 6,3 hexagon insert bits and Wera Series 1 and 4

Design: 1/4" hexagon socket with Wera quick-release chuck and Rapidaptor rapid-in, rapid-out, rapid-spin, chuck-all and single-hand technology

Handle: Kraffform with non-roll feature, multi-component

	 "	 mm
05051464001	1/4"	119

Tip

Chuck-all



The Rapidaptor quick-release chucks hold both 1/4" bits as per DIN ISO 1173-C 6,3 (Wera series 1) and E 6,3 (Wera series 4).

Single-hand



All functions of the quick-release chuck such as the inserting or releasing of bits can be done with just one hand. That is faster, more economic and ergonomic. There are no unnecessary manoeuvres.

Rapid-in and self-lock

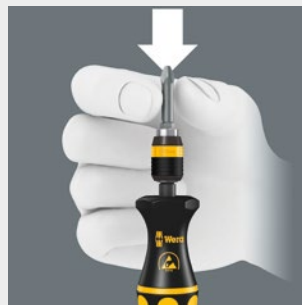

The bit can be pushed into the chuck without moving the sleeve. It automatically locks with a secure and wobble-free fit as soon as the bit is applied to the screw.

Rapid-out

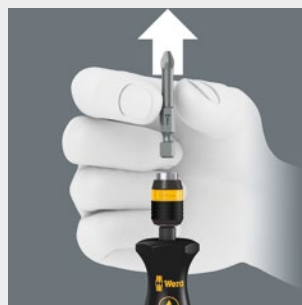

Simply push the sleeve forward to change the bit. The spring mechanism lifts the bit off the magnet and unlocks the tool. The bit can be easily removed. Particularly helpful: even the smallest bits can be removed without any extra tools.



ESD Series

ESD-safe tools

813 R ESD bitholding screwdriver, non-magnetic



Application: Suitable for 1/4" DIN ISO 1173-C and E 6,3 hexagon insert bits and Wera Series 1 and 4

Design: 1/4" hexagon socket with Wera quick-release chuck and Rapidaptor rapid-in, rapid-out, rapid-spin, chuck-all and single-hand technology

Handle: Kraftform with non-roll feature, multi-component

05051273001	1/4"	90

Kraftform Kompakt 60 ESD



Pouch with 89 mm bits

17-piece set

1 Kraftform bitholding screwdriver 816 R ESD with Rapidaptor quick-release chuck

05051043001		
	816 R ESD	1 x 1/4"x119
	851/4 Z PH	1 x PH 1x89; 1 x PH 2x89; 1 x PH 3x89
	855/4 Z PZ	1 x PZ 1x89; 1 x PZ 2x89; 1 x PZ 3x89
	867/4 Z TORX®	1 x TX 10x89; 1 x TX 15x89; 1 x TX 20x89; 1 x TX 25x89; 1 x TX 30x89
	840/4 Z Hex-Plus	1 x 3,0x89; 1 x 4,0x89; 1 x 5,0x89; 1 x 6,0x89
	800/4 Z	1 x 1,0x5,5x89

Kraftform Kompakt Micro 21 ESD 1



21-piece set

Pouch with 44 mm bits

1 Kraftform Micro ESD bitholding screwdriver

05135973001		
	1013 Kraftform Micro ESD	1 x 97
	851/9 C	1 x PH 000x44 ¹⁾ ; 1 x PH 00x44 ¹⁾ ; 1 x PH 0x44 ²⁾
	867/9 C TORX®	1 x TX 1x44; 1 x TX 2x44; 1 x TX 3x44; 1 x TX 4x44; 1 x TX 5x44
	867/9 C TORX PLUS®	1 x 1 IPx44; 1 x 2 IPx44; 1 x 3 IPx44; 1 x 4 IPx44
	867/9 IPR TORX® PLUS	1 x 1 IPRx44
	872/9	1 x mx44; 1 x 00x44; 1 x Fx44; 1 x 0x44
	800/9 C	1 x 0,23x1,5x44; 1 x 0,35x2,5x44
	869/9	1 x 2,5x44,0

¹⁾ Optimised for Asian PH screws

²⁾ Size 0 modified according to JCIS 0 (Japanese Camera Industrial Standard)



Kraftform Kompakt Micro 20 ESD 1



20-piece set
Pouch with 44 mm bits
1 Kraftform Micro ESD bitholding screwdriver

05073671001		
	1013	1 x 97 Kraftform Micro ESD
	851/9 C	1 x PH 00x44 ¹⁾ ; 1 x PH 0x44 ²⁾ ; 1 x PH 1x44 ¹⁾
	867/9 C	1 x TX 1x44; 1 x TX 2x44; 1 x TX 3x44; 1 x TX 4x44; 1 x TX 5x44; 1 x TX 6x44 TORX®
	867/9 C TORX PLUS®	1 x 1 IPx44; 1 x 2 IPx44; 1 x 3 IPx44; 1 x 4 IPx44
	840/9 C	1 x 1,5x44; 1 x 2,0x44
	800/9 C	1 x 0,23x1,5x44; 1 x 0,40x2,0x44; 1 x 0,50x3,0x44
	867/9 IPR TORX® PLUS	1 x 1 IPRx44

¹⁾ Optimised for Asian PH screws
²⁾ Size 0 modified according to JCS 0 (Japanese Camera Industrial Standard)

811/1 ESD bitholding screwdriver



Application: Suitable for 1/4" DIN ISO 1173-C 6,3 hexagon socket bits and Wera Series 1
Design: Extra short, 1/4" hexagon insert bits with retaining ring
Handle: Kraftform, single-component

		mm	mm	
05051106001	1/4"	10	54	3/8"

Kraftform Kompakt Micro 11 ESD 1



11-piece set
Pouch with 44 mm bits
1 Kraftform Micro ESD bitholding screwdriver

05073670001		
	1013	1 x 97 Kraftform Micro ESD
	851/9 C	1 x PH 00x44 ¹⁾ ; 1 x PH 0x44 ²⁾ ; 1 x PH 1x44 ¹⁾
	867/9 C	1 x TX 5x44; 1 x TX 6x44 TORX®
	800/9 C	1 x 0,23x1,5x44; 1 x 0,40x2,0x44; 1 x 0,50x3,0x44
	840/9 C	1 x 1,5x44; 1 x 2,0x44

¹⁾ Optimised for Asian PH screws
²⁾ Size 0 modified according to JCS 0 (Japanese Camera Industrial Standard)

810/1 ESD bitholding screwdriver with retaining ring

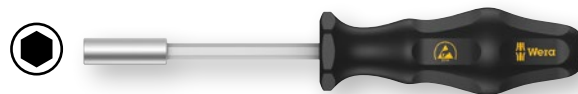





Application: Suitable for 1/4" DIN ISO 1173-C 6,3 hexagon insert bits and Wera Series 1
Blade: Hexagon
Design: 1/4" hexagon socket with retaining ring, chrome-plated
Handle: Kraftform with non-roll feature, single-component

		mm	mm	
05328463001	1/4"	100	112	4"



VDE Tools



	Kraftform Stainless VDE	88
	Kraftform Series 100 VDE	92
	Kraftform Kompakt VDE	106
	Kraftform Comfort VDE	120
	The Zyklop VDE Ratchet and accessories	124

Kraftform Stainless Screwdrivers VDE

Why are stainless elements so often affected by rust? One reason: screwdriving jobs are often carried out with a tool out of made from conventional steel which can result in extraneous rust forming. This is annoying. We were confident that this could be prevented by using tools likewise out of stainless steel and meeting the required standard of industrial hardness.

A tool series out of stainless steel. The forming of extraneous rust is prevented and a special vacuum ice-hardening process ensures the required degree of hardness – and they are even VDE-tested, too.



Solution to the rust problem: screw stainless steel together with stainless steel! Wera stainless steel tools are manufactured out of stainless steel so unsightly rust can be avoided.

The stainless steel tools from Wera are vacuum ice-hardened and have the hardness and strength needed for screw connections. There are no limitations to the industrial applications they are suitable for.



A precisely-focused laser creates a sharp-edged surface structure. This laser treatment results in an edge hardness of up to 1000 HV 0.3. Wera Lasertip "bites" itself into the screw head and prevents any slips out of the recess. It is available for screwdrivers for slotted, Phillips and Pozidriv screws.

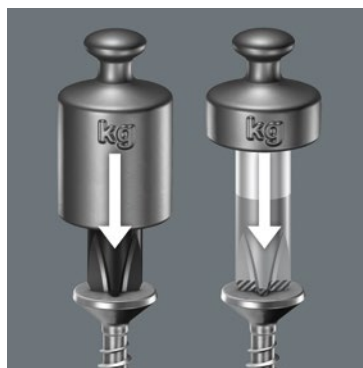

Wera Lasertip reduces the contact pressure required and enhances force transfer – meaning less screwdriving effort is required. Screwdriving becomes safer and easier.



The outstanding design of the Kraftform handle that fits perfectly into the hand prevents hand injuries such as blisters and calluses.



The hard materials used for the handle ensure rapid hand repositioning without any danger of the skin “sticking” to the handle. The surrounding hard zones with large diameters glide like wheels across the hand.

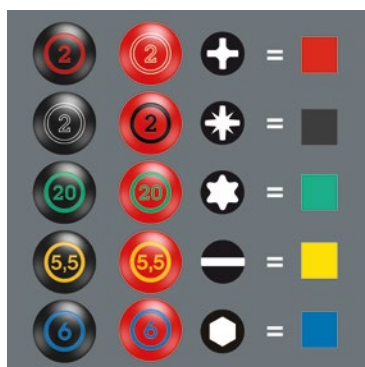

“Take it easy” tool finder: colour coding according to profile and size stamp. This enables faster and more reliable selection of the correct tool from the tool case.



The hexagonal non-roll feature prevents any rolling away at the workplace.

Series Kraftform Screwdrivers

Stainless Steel VDE

3160 i VDE Insulated Screwdriver for slotted screws, stainless



Application: Slotted screws

Blade: Insulated, individually tested as per IEC 60900

Design: Conical edge, Lasertip, stainless steel for minimising rust

Handle: Kraftform with non-roll feature, multi-component. "Take it easy" tool finder: colour coding according to profile (yellow = slotted) and size stamp.

	mm	mm	mm	mm	"	"
05022729001 ¹⁾	0,5	3,0	80	81	1/8"	3 1/8"
05022730001	0,6	3,5	100	81	9/64"	4"
05022731001	0,8	4,0	100	98	5/32"	4"
05022732001	1,0	5,5	125	98	7/32"	5"

¹⁾ without Lasertip

3165 i PZ VDE Insulated screwdriver for Pozidriv screws, stainless



Application: Suitable for Pozidriv screws

Blade: Insulated, individually tested as per IEC 60900

Design: Lasertip, stainless steel for minimising rust

Handle: Kraftform with non-roll feature, multi-component. "Take it easy" tool finder: colour coding according to profile (black = Pozidriv) and size stamp.

		mm	mm	"
05022740001	PZ 1	80	98	3 1/8"
05022741001	PZ 2	100	105	4"

3162 i PH VDE Insulated screwdriver for Phillips screws, stainless



Application: Phillips screws

Blade: Insulated, individually tested as per IEC 60900

Design: Lasertip, stainless steel for minimising rust

Handle: Kraftform with non-roll feature, multi-component. "Take it easy" tool finder: colour coding according to profile (red = Phillips) and size stamp.

		mm	mm	"
05022733001	PH 1	80	98	3 1/8"
05022734001	PH 2	100	105	4"

3160 i/7 Screwdriver set, stainless and rack



Kraftform stainless: the safety screwdriver for stainless steel screws, Lasertip blade + voltage tester + rack. "Take it easy" tool finder: colour coding according to profile and size stamp.

Application: Slotted and Phillips screws

Contents: Stainless steel, 7-piece set and rack in display carton

05022728001	
+	3247 1 x 0,5x3,0x70
+	3162 i VDE 1 x PH 1x80; 1 x PH 2x100
-	3160 i VDE 1 x 0,5x3,0x80 ¹⁾ ; 1 x 0,6x3,5x100; 1 x 0,8x4,0x100; 1 x 1,0x5,5x125

¹⁾ without Lasertip

²⁾ Product not available in the USA and Canada.

3165 i/6 Screwdriver set, stainless and rack



Kraftform stainless: the safety screwdriver for stainless steel screws, Lasertip blade + rack. "Take it easy" tool finder: colour coding according to profile and size stamp.

Application: Slotted and Pozidriv screws

Contents: Stainless steel, 6-piece set and rack in display carton

05022745001	
+	3165 i PZ VDE 1 x PZ 1x80; 1 x PZ 2x100
-	3160 i VDE 1 x 0,5x3,0x80 ¹⁾ ; 1 x 0,6x3,5x100; 1 x 0,8x4,0x100; 1 x 1,0x5,5x125

¹⁾ without Lasertip

Tip

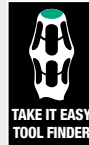

Screwdrivers "Take it easy"



"Take it easy" tool finder: colour coding according to profile and size stamp. This enables faster and more reliable selection of the correct tool from the tool case.



Tested for dielectric strength



Our screwdrivers are tested for dielectric strength under a 10,000 volt load to make sure that their most important property, their insulation, has been exhaustively tested. Each individual Wera VDE screwdriver is subjected to this test to guarantee safe working up to 1,000 volts.

Kraftform Screwdrivers

Series 100 VDE

We want our users to be able to work safely and conveniently.
So we have now transferred the advantages of the Kraftform Plus technology into the VDE segment.



The individual testing at 10,000 volts, in accordance with IEC 60900, ensures safe working with loads up to 1,000 volts.



Impact strength tested at -40°C, guaranteeing safety even under extreme conditions.

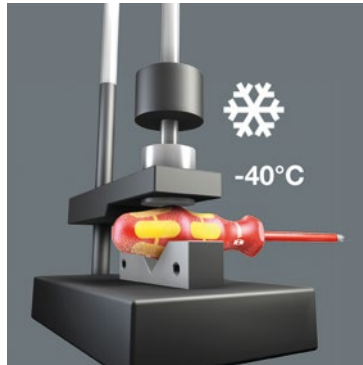

The outstanding design of the Kraftform handle ensures that it fits perfectly into the hand, preventing hand injuries such as blisters and calluses.



The hard materials used for the handle ensure rapid hand repositioning, without any danger of the skin "sticking" to the handle. The softer "anti-slip" zones enable the low-loss transfer of high forces – resulting in less screwdriving effort being required.



A precisely-focused laser creates a sharp-edged surface structure. This laser treatment results in an edge hardness of up to 1000 HV 0.3. Wera Lasertip "bites" itself into the screw head and prevents any slips out of the recess. It is available for screwdrivers for slotted, Phillips and Pozidriv screws.

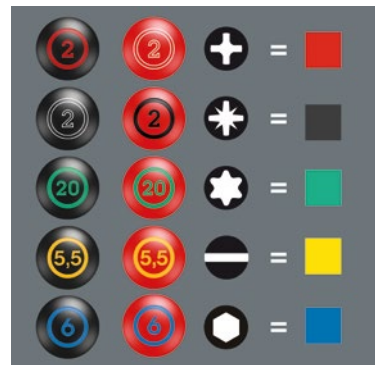

"Take it easy" tool finder: colour coding according to profile and size stamp. This enables faster and more reliable selection of the correct tool from the tool case.



The hexagonal non-roll feature prevents any annoying rolling away at the workplace.

Kraftform Plus – Series 100 VDE

The safety screwdriver for working with live wiring

160 i VDE Insulated screwdriver for slotted screws



Application: Slotted screws

Blade: Insulated, individually tested as per IEC 60900

Design: Conical tip, Lasertip

Handle: Kraftform with non-roll feature, multi-component. "Take it easy" tool finder: colour coding according to profile (yellow = slotted) and size stamp.

	\perp mm	\perp mm	\perp mm	\perp mm	\perp mm	\perp mm
05006100001 ¹⁾	0,4	2,5	80	81	$\frac{3}{32}$ "	$3 \frac{1}{8}$ "
05006105001 ¹⁾	0,5	3,0	100	81	$\frac{1}{8}$ "	4"
05006110001	0,6	3,5	100	81	$\frac{9}{64}$ "	4"
05006115001	0,8	4,0	100	98	$\frac{5}{32}$ "	4"
05006116001	0,8	4,0	150	98	$\frac{5}{32}$ "	6"
05006120001	1,0	5,5	125	98	$\frac{7}{32}$ "	5"
05006121001	1,0	5,5	200	98	$\frac{7}{32}$ "	8"
05006125001	1,2	6,5	150	105	$\frac{1}{4}$ "	6"
05006126001	1,2	6,5	200	105	$\frac{1}{4}$ "	8"
05006130001	1,2	8,0	175	112	$\frac{5}{16}$ "	7"
05006135001	1,6	8,0	200	112	$\frac{5}{16}$ "	8"
05006140001	1,6	10,0	200	112	$\frac{3}{8}$ "	8"

¹⁾ without Lasertip

160 i SB VDE Insulated screwdriver for slotted screws

		4013288	
05100000001	● 1 x 0.4x2.5x80 ¹⁾	181466	
05100001001	● 1 x 0.5x3.0x100 ¹⁾	181473	
05100002001	● 1 x 0.6x3.5x100	181480	
05100003001	● 1 x 0.8x4.0x100	181497	
05100004001	● 1 x 1.0x5.5x125	181503	



160 iS VDE Insulated screwdriver with reduced blade diameter for slotted screws



Application: Slotted screws and actuating tool for spring terminals

Blade: Reduced blade diameter with integrated protective insulation, allows sunken screws and spring elements to be accessed and actuated, individually tested as per IEC 60900

Design: Conical blade, zinc-phosphated

Handle: Kraftform with non-roll feature, multi-component. "Take it easy" tool finder: colour coding according to profile (yellow = slotted) and size stamp.

	\perp mm	\perp mm	\perp mm	\perp mm	\perp mm	\perp mm
05006440001	0,6	3,5	100	81	$\frac{9}{64}$ "	4"
05006441001	0,8	4,0	100	98	$\frac{5}{32}$ "	4"
05006442001	1,0	5,5	125	98	$\frac{7}{32}$ "	5"

160 iSS VDE Insulated screwdriver with reduced blade diameter for slotted screws



Application: Slotted screws and actuating tool for spring terminals

Blade: Reduced blade diameter with integrated protective insulation, allows sunken screws and spring elements to be accessed and actuated, individually tested as per IEC 60900

Design: Conical blade, zinc-phosphated

Handle: Kraftform with non-roll feature, multi-component. "Take it easy" tool finder: colour coding according to profile (yellow = slotted) and size stamp.

	\perp mm	\perp mm	\perp mm	\perp mm	\perp mm	\perp mm
05020129001	0,8	4,0	100	81	$\frac{5}{32}$ "	4"

162 i PH VDE Insulated screwdriver for Phillips screws



Application: Phillips screws

Blade: Insulated, individually tested as per IEC 60900

Design: Lasertip

Handle: Kraftform with non-roll feature, multi-component. "Take it easy" tool finder: colour coding according to profile and size stamp.

	+	mm	mm	"
05006150001 ¹⁾	PH 0	80	81	3 1/8"
05006152001	PH 1	80	98	3 1/8"
05006153001	PH 1	150	98	6"
05006154001	PH 2	100	105	4"
05006159001	PH 2	200	105	8"
05006156001	PH 3	150	112	6"
05006158001 ¹⁾	PH 4	200	112	8"

¹⁾ without Lasertip

162 i PH SB VDE Insulated screwdriver for Phillips screws

		4013288
05100011001	1 x PH 1x80	181442
05100012001	1 x PH 2x100	181459



Tip

VDE-insulated screwdriver with reduced blade diameter

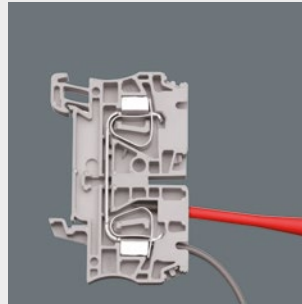

Reduced blade diameter with integrated protective insulation, allows sunken screws and spring elements to be accessed and actuated, individually tested as per IEC 60900.



How to prevent the screwdriver from slipping out of the screw head?



It happens time and time again that the tip slips out of the screw head when screwdriving, sometimes damaging valuable surfaces or even causing injury. The tips of the Wera Lasertip screwdrivers are microscopically roughened by means of a laser. This rough surface literally "bites" itself firmly into the screw head. Slipping out becomes a thing of the past.

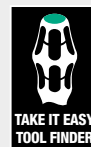

Screwdrivers "Take it easy"

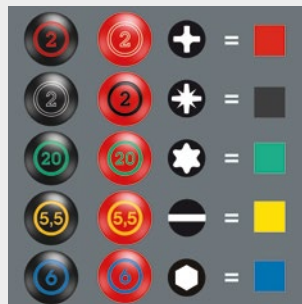

"Take it easy" tool finder: colour coding according to profile and size stamp. This enables faster and more reliable selection of the correct tool from the tool case.

Kraftform Plus – Series 100 VDE

The safety screwdriver for working with live wiring

162 iS PH VDE Insulated screwdriver with reduced blade diameter for Phillips screws



Application: Phillips screws

Blade: Reduced blade diameter with integrated protective insulation, allows sunken PH screws to be accessed and actuated, individually tested as per IEC 60900

Design: Blade zinc-phosphated

Handle: Kraftform with non-roll feature, multi-component. "Take it easy" tool finder: colour coding according to profile (red = Phillips) and size stamp.

	+	mm	mm	"
05006450001	PH 1	80	98	3 1/8"
05006451001	PH 2	100	105	4"

162 iSS PH VDE Insulated screwdriver with reduced blade diameter for Phillips screws



Application: Phillips screws

Blade: Reduced blade diameter with integrated protective insulation, allows sunken PH screws to be accessed and actuated, individually tested as per IEC 60900

Design: Blade zinc-phosphated

Handle: Kraftform with non-roll feature, multi-component. "Take it easy" tool finder: colour coding according to profile (red = Phillips) and size stamp.

	+	mm	mm	"
05020131001	PH 1	80	81	3 1/8"
05020133001	PH 2	100	98	4"

165 i PZ VDE Insulated screwdriver for Pozidriv screws



Application: Suitable for Pozidriv screws

Blade: Insulated, individually tested as per IEC 60900

Design: Lasertip

Handle: Kraftform with non-roll feature, multi-component. "Take it easy" tool finder: colour coding according to profile (black = Pozidriv) and size stamp.

	+	mm	mm	"
05006160001 ¹⁾	PZ 0	80	81	3 1/8"
05006162001	PZ 1	80	98	3 1/8"
05006163001	PZ 1	150	98	6"
05006164001	PZ 2	100	105	4"
05006165001	PZ 2	200	105	8"
05006166001	PZ 3	150	112	6"
05006168001 ¹⁾	PZ 4	200	112	8"

¹⁾ without Lasertip

165 i PZ SB VDE Insulated screwdriver for Pozidriv screws

		4013288
05100015001	1 x PZ 1x80	181510
05100016001	1 x PZ 2x100	181527



165 iS PZ VDE Insulated screwdriver with reduced blade diameter for Pozidriv screws



Application: Suitable for Pozidriv screws

Blade: Reduced blade diameter with integrated protective insulation, allows sunken PZ screws to be accessed and actuated, individually tested as per IEC 60900

Design: Blade zinc-phosphated

Handle: Kraftform with non-roll feature, multi-component. "Take it easy" tool finder: colour coding according to profile (black = Pozidriv) and size stamp.

		mm	mm	in
05006460001	PZ 1	80	98	3 1/8"
05006461001	PZ 2	100	105	4"

162 i PH/S VDE Insulated screwdriver for PlusMinus screws (Phillips/slotted)



Application: PlusMinus screws (Phillips/slotted)

Blade: Insulated, individually tested as per IEC 60900

Design: PlusMinus (Phillips/slotted)

Handle: Kraftform with non-roll feature, multi-component

		mm	mm	in
05006380001	# 1	80	98	3 1/8"
05006381001	# 2	100	105	4"

162 i PH/S SB VDE Insulated screwdriver for PlusMinus screws (Phillips/slotted)

		4013288	
05100019001	162 i PH/S VDE	186560	1 x # 1x80
05100020001	162 i PH/S VDE	186577	1 x # 2x100



Tip

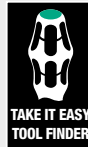

Screwdrivers "Take it easy"



"Take it easy" tool finder: colour coding according to profile and size stamp. This enables faster and more reliable selection of the correct tool from the tool case.



PlusMinus screwdrivers



For the use in terminal blocks, control cabinets, switches, relays, sockets etc.

Non-roll feature

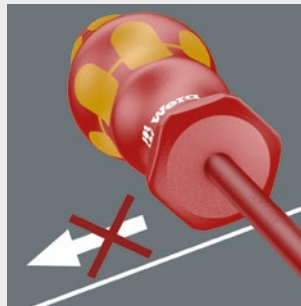

All Kraftform screwdrivers have a non-roll feature at the lower end of the handle. The hexagonal design prevents any annoying rolling away of the screwdriver at the workplace.

Kraftform Plus – Series 100 VDE

The safety screwdriver for working with live wiring

162 iS PH/S VDE Insulated screwdriver with reduced blade diameter for PlusMinus screws (Phillips/slotted)



- Application:** PlusMinus screws (Phillips/slotted)
- Blade:** Reduced blade diameter with integrated protective insulation, allows sunken PlusMinus screws to be accessed and actuated, individually tested as per IEC 60900
- Design:** Combination profile Phillips/slotted, blade zinc-phosphated
- Handle:** Kraftform with non-roll feature, multi-component

		mm	mm	
05006455001	# 1	80	98	3 1/8"
05006456001	# 2	100	105	4"

165 iS PZ/S VDE Insulated screwdriver with reduced blade diameter for PlusMinus screws (Pozidriv/slotted)



- Application:** For PlusMinus screws (Pozidriv/slotted)
- Blade:** Reduced blade diameter with integrated protective insulation, allows sunken PlusMinus screws to be accessed and actuated, individually tested as per IEC 60900
- Design:** PlusMinus (Pozidriv/slotted), blade zinc-phosphated
- Handle:** Kraftform with non-roll feature, multi-component

		mm	mm	
05006465001	# 1	80	98	3 1/8"
05006466001	# 2	100	105	4"

165 i PZ/S VDE Insulated screwdriver for PlusMinus screws (Pozidriv/slotted)



- Application:** For PlusMinus screws (Pozidriv/slotted)
- Blade:** Insulated, individually tested as per IEC 60900
- Design:** PlusMinus (Pozidriv/slotted)
- Handle:** Kraftform with non-roll feature, multi-component

		mm	mm	
05006190001	# 1	80	98	3 1/8"
05006191001	# 2	100	105	4"

165 iSS PZ/S VDE Insulated screwdriver with reduced blade diameter for PlusMinus screws (Pozidriv/slotted)



- Application:** For PlusMinus screws (Pozidriv/slotted)
- Blade:** Reduced blade diameter with integrated protective insulation, allows sunken PlusMinus screws to be accessed and actuated, individually tested as per IEC 60900
- Design:** PlusMinus (Pozidriv/slotted), blade zinc-phosphated
- Handle:** Kraftform with non-roll feature, multi-component

		mm	mm	
05020132001	# 1	80	81	3 1/8"
05020134001	# 2	100	98	4"

165 i PZ/S SB VDE Insulated screwdriver for PlusMinus screws (Pozidriv/slotted)

		4013288
05100021001	165 i PZ/S VDE 1 x # 1x80	186584
05100022001	165 i PZ/S VDE 1 x # 2x100	186591



167 i VDE Insulated screwdriver for TORX® screws



Application: TORX® socket screws

Blade: Insulated, individually tested as per IEC 60900

Design: Zinc-phosphated

Handle: Kraffform with non-roll feature, multi-component. "Take it easy" tool finder: colour coding according to profile (green = TORX®) and size stamp.

		mm	mm	"
05006181001	TX 5	80	81	3 1/8"
05006182001	TX 6	80	81	3 1/8"
05006183001	TX 7	80	81	3 1/8"
05006184001	TX 8	80	81	3 1/8"
05006169001	TX 9	80	81	3 1/8"
05006170001	TX 10	80	81	3 1/8"
05006172001	TX 15	80	98	3 1/8"
05006174001	TX 20	80	98	3 1/8"
05006176001	TX 25	100	105	4"
05006177001	TX 27	100	105	4"
05006178001	TX 30	100	105	4"
05006179001	TX 40	150	112	6"
05006186001	TX 45	150	112	6"

164 i VDE Insulated screwdriver for hexagon socket screws



Application: Hexagon socket screws

Blade: Insulated, individually tested as per IEC 60900

Design: Zinc-phosphated

Handle: Kraffform with non-roll feature, multi-component. "Take it easy" tool finder: colour coding according to profile (blue = hexagon) and size stamp.

	mm	mm	mm	"
05004650001	2,5	80	98	3 1/8"
05004655001	3,0	80	98	3 1/8"
05004660001	4,0	80	98	3 1/8"
05004665001	5,0	80	105	3 1/8"
05004670001	6,0	100	105	4"
05004675001	8,0	100	112	4"

Tip

Tested for dielectric strength



Our screwdrivers are tested for dielectric strength under a 10,000 volt load to make sure that their most important property, their insulation, has been exhaustively tested. Each individual Wera VDE screwdriver is subjected to this test to guarantee safe working up to 1,000 volts.



The super slim VDE screwdrivers



The super slim VDE screwdrivers for installation jobs in particularly confined spaces. Not only do the blades have a reduced diameter, the handles also have a very slim design.

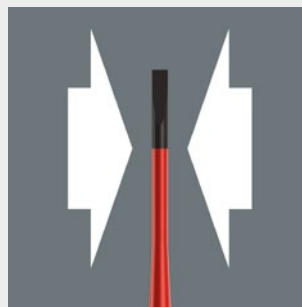









Kraftform Plus – Series 100 VDE

The safety screwdriver for working with live wiring





168 i VDE Insulated screwdriver for square socket head screws



- Application:** Square socket head screws
Blade: Insulated, individually tested as per IEC 60900
Design: Zinc-phosphated
Handle: Kraftform with non-roll feature, multi-component

					
		mm	mm	"	
05004780001		# 1	80	98	3 1/8"
05004783001		# 1	150	98	6"
05004781001		# 2	100	105	4"
05004784001		# 2	200	105	8"
05004782001		# 3	150	112	6"

168 i SB VDE Insulated screwdriver for square socket head screws







		
		4013288
05100024001	 1 x # 1x80	181534
05100025001	 1 x # 2x100	181541
05100026001	 1 x # 3x150	181558



190 i VDE Insulated nutdriver



- Application:** Hexagon headed bolts, screws and nuts
Blade: Insulated, individually inspected as per IEC 60900
Design: Zinc-phosphated
Handle: Kraftform with non-roll feature, multi-component







						
	mm	mm	mm	mm	mm	"
05005300001	5,5	125	98	11,0	5"	
05005305001	6,0	125	98	12,0	5"	
05005310001	7,0	125	105	14,0	5"	
05005315001	8,0	125	105	15,0	5"	
05005320001	9,0	125	105	16,0	5"	
05005325001	10,0	125	112	17,0	5"	
05005330001	11,0	125	112	19,0	5"	
05005335001	12,0	125	112	20,0	5"	
05005340001	13,0	125	112	21,0	5"	
05104900001	-	3/16"	125	98	11,0	5"
05345280001	-	7/32"	125	98	12,0	5"
05104905001	-	1/4"	125	98	13,0	5"
05104901001	-	5/16"	125	105	15,0	5"
05104906001	-	3/8"	125	105	17,0	5"
05104902001	-	7/16"	125	112	19,0	5"
05104904001	-	1/2"	125	112	21,0	5"
05104903001	-	9/16"	125	112	23,0	5"
05104907001	-	5/8"	125	112	25,0	5"

247 Single-pole voltage tester









Application: Voltage testing

Standard: ISO 57680/6 and VDE 0680/6 for 150 to 250 V

						
	mm	mm	mm	mm	"	"
05005655001	0,5	3,0	70	3,0	1/8"	2 3/4"

Product not available in the USA and Canada.

247 SB Single-pole voltage tester

					
mm	mm	mm	mm	"	"
05100100001	1 x 0.5	3.0	70	1/8"	2 3/4"

Product not available in the USA and Canada.

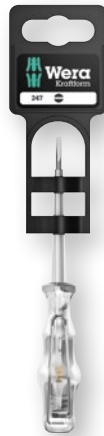

Tip



Why is the Kraftform Plus handle made out of several components?



Wera produces the Kraftform handle out of several materials with different properties. A resistant plastic is used for the core which ensures that the blade is held securely even under high strain. A softer material is used for the coloured soft zones, which provides high frictional resistance and allows the transfer of high

forces – resulting in less required screwdriving effort. The red sections with their hard surfaces prevent any “sticking” of the hand to the handle, making rapid repositioning of the hand possible.



Impact strength



Impact strength tested at -40°C, guaranteeing safety even under extreme conditions.

Kraftform Plus – Series 100 VDE

The safety screwdriver for working with live wiring

Kraftform Big Pack 100 VDE

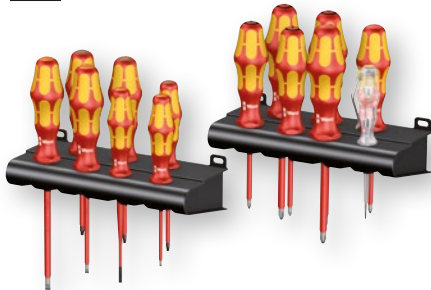

Kraftform: The safety screwdriver with Lasertip blade, voltage tester and rack. "Take it easy" tool finder: colour coding according to profile and size stamp.

Application: Slotted, Phillips, PlusMinus (Pozidriv/slotted), Pozidriv and TORX® screws

Content: 14-piece set in display carton

05105631001	
+	162 i PH VDE 1 x PH 1x80; 1 x PH 2x100
+	165 i PZ VDE 1 x PZ 1x80; 1 x PZ 2x100
+	165 i PZ/S VDE 1 x # 1x80; 1 x # 2x100
+	167 i TORX® VDE 1 x TX 10x80; 1 x TX 15x80; 1 x TX 20x80
⊖	160 iS 1 x 0,6x3,5x100
⊖	160 i VDE 1 x 0,4x2,5x80 ¹⁾ ; 1 x 0,8x4,0x100; 1 x 1,0x5,5x125
⊖	247 1 x 0,5x3,0x70
	Rack 2 x 190,0x50,0

¹⁾ without Lasertip

²⁾ Product not available in the USA and Canada.

160 i/6 Rack Screwdriver Set Kraftform Plus Series 100 + Rack



Kraftform: The safety screwdriver. Lasertip blade + rack. "Take it easy" tool finder: colour coding according to profile and size stamp.

Application: For slotted and Phillips screws

Content: 6-pieces set and rack in display carton

05006145001	
+	162 i PH VDE 1 x PH 1x80; 1 x PH 2x100
⊖	160 i VDE 1 x 0,4x2,5x80 ¹⁾ ; 1 x 0,6x3,5x100; 1 x 0,8x4,0x100; 1 x 1,0x5,5x125

¹⁾ without Lasertip

160 i/7 Rack screwdriver set Kraftform Plus Series 100, voltage tester and rack



Kraftform: The safety screwdriver with Lasertip blade, voltage tester and rack. "Take it easy" tool finder: colour coding according to profile and size stamp.

Application: Slotted and Phillips screws

Content: 7-piece set and rack in display carton

05006147001	
+	162 i PH VDE 1 x PH 1x80; 1 x PH 2x100
⊖	160 i VDE 1 x 0,4x2,5x80 ¹⁾ ; 1 x 0,6x3,5x100; 1 x 0,8x4,0x100; 1 x 1,0x5,5x125
⊖	247 1 x 0,5x3,0x70

¹⁾ without Lasertip

²⁾ Product not available in the USA and Canada.

160 i/165 i/7 Rack screwdriver set Kraffform Plus Series 100, voltage tester and rack



Kraffform: The safety screwdriver with Lasertip blade, voltage tester and rack. "Take it easy" tool finder: colour coding according to profile and size stamp.

Application: Slotted and Pozidriv screws

Content: 7-piece set and rack in display carton

05006148001	
+	165 i PZ VDE 1 x PZ 1x80; 1 x PZ 2x100
-	160 i VDE 1 x 0,4x2,5x80 ¹⁾ ; 1 x 0,6x3,5x100; 1 x 0,8x4,0x100; 1 x 1,0x5,5x125
-	247 1 x 0,5x3,0x70

¹⁾ without Lasertip

²⁾ Product not available in the USA and Canada.

167 i/6 Screwdriver set Kraffform Plus Series 100



Kraffform: The safety screwdriver. "Take it easy" tool finder: colour coding according to profile and size stamp.

Application: TORX® socket screws

Content: 6-piece set

05133356001	
+	167 i TORX® VDE 1 x TX 8x80; 1 x TX 9x80; 1 x TX 10x80; 1 x TX 15x80; 1 x TX 20x80; 1 x TX 25x100

Tip



Screwdrivers "Take it easy"



"Take it easy" tool finder: colour coding according to profile and size stamp. This enables faster and more reliable selection of the correct tool from the tool case.



Tested for dielectric strength



Our screwdrivers are tested for dielectric strength under a 10,000 volt load to make sure that their most important property, their insulation, has been exhaustively tested. Each individual Wera VDE screwdriver is subjected to this test to guarantee safe working up to 1,000 volts.



Lasertip



A precisely-focused laser creates a sharp-edged surface structure. This laser treatment results in an edge hardness of up to 1000 HV 0.3. Wera Lasertip "bites" itself into the screw head and prevents any slips out of the recess. It is available for screwdrivers for slotted, Phillips and Pozidriv screws.

Kraftform Plus – Series 100 VDE

The safety screwdriver for working with live wiring

160 iS/7 Rack screwdriver set Kraftform Plus Series 100, voltage tester and rack. With reduced blade diameter



Kraftform: The safety screwdriver. With reduced blade diameter, voltage tester and rack. "Take it easy" tool finder: colour coding according to profile and size stamp.

Application: Slotted, Phillips, PlusMinus screws (Pozidriv/slotted)

Content: 7-piece set and rack in display carton

05006480001		
+	162 iS	1 x PH 1x80; 1 x PH 2x100
+	165 iS PZ/S	1 x # 2x100
+	160 iS	1 x 0,6x3,5x100; 1 x 0,8x4,0x100; 1 x 1,0x5,5x125
+	247	1 x 0,5x3,0x70

^{*)} Product not available in the USA and Canada.

160 iSS/7 screwdriver set Kraftform Plus Series 100. With reduced blade diameter and smaller handle diameters



Kraftform: The safety screwdriver. With reduced blade diameter and partially smaller handle diameters. "Take it easy" tool finder: colour coding according to profile and size stamp.

Application: Slotted, Phillips, PlusMinus screws (Pozidriv/slotted)

Content: 7-piece set

05135961001		
+	160 iSS	1 x 0,8x4,0x100
+	160 iS	1 x 0,6x3,5x100; 1 x 1,0x5,5x125
+	162 iSS	1 x PH 1x80; 1 x PH 2x100
+	165 iSS PZ/S	1 x # 1x80; 1 x # 2x100

160 i/168 i/6 Rack screwdriver set Kraftform Plus Series 100 and rack



Kraftform: The safety screwdriver. Lasertip blade + rack. "Take it easy" tool finder: colour coding according to profile and size stamp.

Application: For slotted, Phillips and square socket screws

Content: 6-pieces set and rack in display carton

05347777001		
+	162 i PH VDE	1 x PH 1x80; 1 x PH 2x100
+	160 i VDE	1 x 0,6x3,5x100; 1 x 1,0x5,5x125
+	168 i VDE	1 x # 1x80; 1 x # 2x100

160 i/162 i/167 i/9 Screwdriver set Kraftform Plus Series 100



Kraftform: The safety screwdriver. "Take it easy" tool finder: colour coding according to profile and size stamp.

Application: Slotted, Phillips, Pozidriv, PlusMinus (Pozidriv/slotted) and TORX® socket screws

Content: 9-piece set

05133355001		
+	162 i PH VDE	1 x PH 2x100
+	165 i PZ VDE	1 x PZ 2x100
+	165 i PZ/S VDE	1 x # 1x80; 1 x # 2x100
+	167 i TORX® VDE	1 x TX 15x80; 1 x TX 20x80; 1 x TX 25x100
+	160 i VDE	1 x 0,4x2,5x80 ¹⁾ ; 1 x 1,0x5,5x125

¹⁾ without Lasertip

Kraftform 2go 100

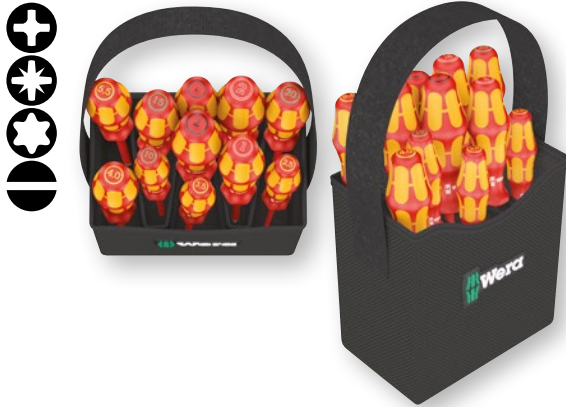

11 VDE-insulated, Kraftform screwdrivers for cross recess screws Phillips and Pozidriv, TORX® and slotted screws. "Take it easy" tool finder: colour coding according to profile and size stamp.

1 dimensionally stable and robust Tool Quiver, equipped with handle for the storage and transport of tools; high resistance against cuts and stabs; comes with hook and loop fastener zone for docking with the Wera 2go system and includes 1 variably adjustable hook and loop fastener partition for a division into as many as 5 sections.

05004310001	
	Wera 2go 4 1 x 165,0x165,0x105
+	162 i PH VDE 1 x PH 1x80; 1 x PH 2x100
+	165 i PZ VDE 1 x PZ 1x80; 1 x PZ 2x100
⊕	167 i TORX® 1 x TX 10x80; 1 x TX 15x80; 1 x TX 20x80
⊖	160 i VDE 1 x 0,4x2,5x80 ¹⁾ ; 1 x 0,8x4,0x150; 1 x 1,0x5,5x200
⊖	160 iS 1 x 0,6x3,5x100
	Hook and Loop Fastener Strip 120

¹⁾ without Lasertip

Tip

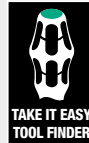

Screwdrivers "Take it easy"



"Take it easy" tool finder: colour coding according to profile and size stamp. This enables faster and more reliable selection of the correct tool from the tool case.

At the workplace and when out and about



The large set-down area improves the stability of the Tool Quiver. Its large handle means that the quiver can be easily transported or simply hung up at the workplace.

High resistance against cuts and stabs



The robust and dimensionally stable material is very resistant against cuts and stabs. The tools carried are protected against damage and moisture. This enhances the service life of the tool box.

Perfect system supplement

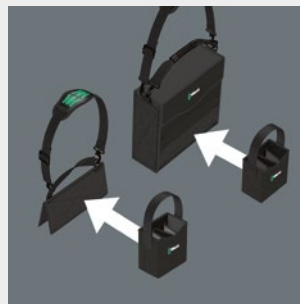

Thanks to its hook and loop fastener zone, the Tool Box can be docked with the Wera 2go 1 Tool Carrier and with the Wera 2go 2 Tool Container.



Kraftform Kompakt VDE

Why is the right tool so often missing at the workplace? The reason: too many tools and overly-heavy tool bags can make it bothersome to carry keep them with you.

So for us it was a clear challenge: to develop a tool that is suitable for a whole host of applications and can be easily taken along to the workplace.

Our solution: Kraftform Kompakt tools. A handle into which blades with a range of different profiles can be inserted. Compactly and protectively housed in a light and robust textile pouch – and they are even VDE-tested, too.



Kraftform Kompakt VDE sets come with an insulated handle and insulated interchangeable blades, that can be exchanged without any special tools.



The handle/interchangeable blade system allows rapid exchange of the blades required for a wide range of applications.



Each Kraftform Kompakt VDE set has been tested individually at 10,000 volts, in accordance with IEC 60900. This ten-times-higher testing load guarantees safe working at their maximum permitted load of 1,000 volts.



The tools can be stored and carried in a robust belt pouch, keeping them always to hand.



The hard materials used for the handle ensure rapid hand repositioning, without any danger of the skin “sticking” to the handle. The softer “anti-slip” zones enable the low-loss transfer of high forces – resulting in less screwdriving effort being required.



The outstanding design of the Kraftform handle ensures that it fits perfectly into the hand, preventing hand injuries such as blisters and calluses.

Kraftform Kompakt VDE

Versatile tools for work on live wiring

Kraftform Kompakt VDE 15 Torque 1.2-3.0 Nm extra slim 1



1 Series 7400 VDE Kraftform adjustable torque handle (1.2 - 3.0 Nm) for Wera VDE interchangeable blades only

VDE interchangeable blades (each 154 mm long) with reduced blade diameter (articles KK 60 i 0,4x2,5 and KK 67 i TX 10 conventional diameter) with integrated protective insulation, allows sunken screws and spring elements to be accessed and actuated

15-piece set

05059291001	
●	7400 VDE 1 x 7441 VDEx1,2-3,0
+	KK 62 iS 1 x PH 1x154; 1 x PH 2x154
+	KK 65 iS PZ 1 x PZ 1x154; 1 x PZ 2x154
+	KK 65 iS PZ/S 1 x # 1x154; 1 x # 2x154
+	KK 67 i TORX® 1 x TX 10x154
+	KK 67 iS 1 x TX 15x154; 1 x TX 20x154; 1 x TX 25x154 TORX®
●	KK 60 i 1 x 0,4x2,5x154
●	KK 60 iS 1 x 0,6x3,5x154; 1 x 0,8x4,0x154; 1 x 1,0x5,5x154

Kraftform Kompakt VDE 16 Torque 1.2-3.0 Nm extra slim 1



1 Series 7400 VDE Kraftform adjustable torque handle (1.2 - 3.0 Nm) and 1 Kraftform handle 817 VDE for Wera VDE interchangeable blades only

VDE interchangeable blades (each 154 mm long) with reduced blade diameter (articles KK 60 i 0,4x2,5 and KK 67 i TX 10 conventional diameter) with integrated protective insulation, allows sunken screws and spring elements to be accessed and actuated

16-piece set

05135906001	
●	7400 VDE 1 x 7441 VDE, 1,2-3,0 Nm
●	817 VDE 1 x 9x102
+	KK 62 iS 1 x PH 1x154; 1 x PH 2x154
+	KK 65 iS PZ 1 x PZ 1x154; 1 x PZ 2x154
+	KK 65 iS PZ/S 1 x # 1x154; 1 x # 2x154
+	KK 67 i TORX® 1 x TX 10x154
+	KK 67 iS 1 x TX 15x154; 1 x TX 20x154; 1 x TX 25x154 TORX®
●	KK 60 i 1 x 0,4x2,5x154
●	KK 60 iS 1 x 0,6x3,5x154; 1 x 0,8x4,0x154; 1 x 1,0x5,5x154

Kraftform Kompakt VDE 18 Universal 1



1x Kraftform handle 817 VDE for Wera VDE interchangeable blades only

VDE interchangeable blades (each 154 mm long)

Single-pole voltage tester

18-piece set

05003471001	
●	817 VDE 1 x 9x102
⊕	KK 62 i 1 x PH 1x154; 1 x PH 2x154
⊕	KK 62 i PH/S 1 x # 1x154; 1 x # 2x154
⊕	KK 65 i PZ 1 x PZ 1x154; 1 x PZ 2x154
⊕	KK 65 i PZ/S 1 x # 1x154; 1 x # 2x154
●	KK 60 i 1 x 0,4x2,5x154; 1 x 0,6x3,5x154; 1 x 0,8x4,0x154; 1 x 1,0x5,5x154
●	KK 96 VK 6,3 1 x 6,3x89
●	KK 97 VK 8,1 1 x 8,1x89
△	KK 98 DK 1 x 89
⦿	KK 99 FL 1 x 89
●	247 1 x 0,5x3,0x70

Product not available in the USA and Canada.

Tip



Kraftform VDE adjustable torque handle



Simple setting of the required torque by hand.

Easy-to-read scale value. Measurement accuracy is $\pm 6\%$ in accordance with the standard EN ISO 6789.

Distinctly audible and noticeable excess-load signal when the pre-set torque is reached.

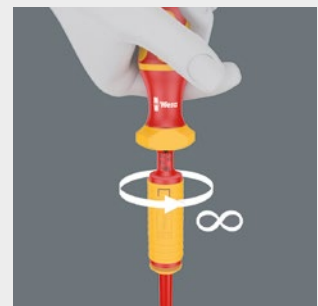
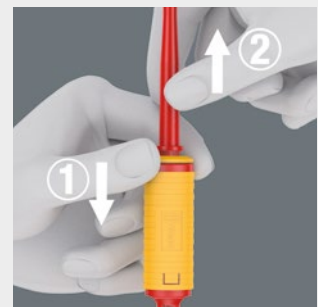
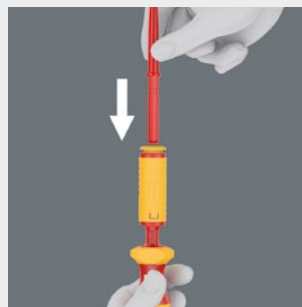

Kraftform Kompakt VDE

Versatile tools for work on live wiring

Kraftform Kompakt VDE 18 Imperial 1



2x Kraftform handle 817 VDE for Wera VDE interchangeable blades only
 VDE interchangeable blades (154 mm long)
 18-piece set

05347108001	
●	817 VDE 2 x 9x102
⊕	KK 62 i 1 x PH 1x154; 1 x PH 2x154
⊕	KK 62 i PH/S 1 x # 1x154; 1 x # 2x154
⊕	KK 65 i PZ/S 1 x # 1x154; 1 x # 2x154
●	KK 60 i 1 x 0,4x2,5x154; 1 x 0,6x3,5x154; 1 x 0,8x4,0x154; 1 x 1,0x5,5x154
○	KK 68 i 1 x # 1x154; 1 x # 2x154
○	KK 96 VK 6,3 1 x 6,3x89
○	KK 97 VK 8,1 1 x 8,1x89
△	KK 98 DK 1 x 89
◐	KK 99 FL 1 x 89

Kraftform Kompakt VDE 18 Universal 2



2x Kraftform handle 817 VDE for Wera VDE interchangeable blades only
 VDE interchangeable blades (each 154 mm long)
 18-piece set

05347107001	
●	817 VDE 2 x 9x102
⊕	KK 62 i 1 x PH 1x154; 1 x PH 2x154
⊕	KK 62 i PH/S 1 x # 1x154; 1 x # 2x154
●	KK 60 i 1 x 1,0x5,5x154; 1 x 0,4x2,5x154; 1 x 0,6x3,5x154; 1 x 0,8x4,0x154
⊕	KK 65 i PZ 1 x PZ 1x154; 1 x PZ 2x154
⊕	KK 65 i PZ/S 1 x # 1x154; 1 x # 2x154
○	KK 96 VK 6,3 1 x 6,3x89
○	KK 97 VK 8,1 1 x 8,1x89
△	KK 98 DK 1 x 89
◐	KK 99 FL 1 x 89

Kraftform Kompakt VDE 17 Universal 1



2x 817 VDE Kraftform handle for Wera VDE interchangeable blades only

VDE exchangeable blades (each 154 mm long)

17-piece set

05059030001	
●	817 VDE 2 x 9x102
+	KK 62 i 1 x PH 1x154; 1 x PH 2x154
+	KK 65 i PZ 1 x PZ 1x154; 1 x PZ 2x154
+	KK 65 i PZ/S 1 x # 1x154; 1 x # 2x154
+	KK 67 i TORX® 1 x TX 10x154; 1 x TX 15x154; 1 x TX 20x154; 1 x TX 25x154
—	KK 60 i 1 x 0,4x2,5x154; 1 x 0,8x4,0x154; 1 x 1,0x5,5x154; 1 x 1,2x6,5x154
—	KK 60 iS 1 x 0,6x3,5x154

Tip

One handle – many interchangeable blades



The system “one handle – many interchangeable blades” makes Kraftform Kompakt VDE compact screwdriving sets for in-house as well as mobile electrical applications out of the sets. The belt pouch is practical for tidy storage and transportation. Also available with electrical cabinet keys conforming to the industrial standards.



Tested for dielectric strength



Our screwdrivers are tested for dielectric strength under a 10,000 volt load to make sure that their most important property, their insulation, has been exhaustively tested. Each individual Wera VDE screwdriver is subjected to this test to guarantee safe working up to 1,000 volts.

Kraftform Kompakt VDE

Versatile tools for work on live wiring

Kraftform Kompakt VDE 16 Universal 1



1 Kraftform handle 817 VDE for Wera VDE interchangeable blades only

VDE interchangeable blades (each 154 mm long)

Single-pole voltage tester

16-piece set

05003474001	
●	817 VDE 1 x 9x102
⊕	KK 62 i 1 x PH 1x154; 1 x PH 2x154
⊕	KK 65 i PZ 1 x PZ 1x154; 1 x PZ 2x154
⊕	KK 65 i PZ/S 1 x # 1x154; 1 x # 2x154
⊕	KK 67 i TORX® 1 x TX 10x154; 1 x TX 15x154; 1 x TX 20x154; 1 x TX 25x154
●	KK 60 i 1 x 0,4x2,5x154; 1 x 0,6x3,5x154; 1 x 0,8x4,0x154; 1 x 1,0x5,5x154
●	247 1 x 0,5x3,0x70

Product not available in the USA and Canada.

Kraftform Kompakt VDE 16 extra slim 1



1 Kraftform handle 817 VDE for Wera VDE interchangeable blades only

VDE interchangeable blades (each 154 mm long) with reduced blade diameter with integrated protective insulation, allows sunken screws and spring elements to be accessed and actuated

Single-pole voltage tester

16-piece set

05003484001	
●	817 VDE 1 x 9x102
⊕	KK 62 iS 1 x PH 1x154; 1 x PH 2x154
⊕	KK 65 iS PZ 1 x PZ 1x154; 1 x PZ 2x154
⊕	KK 65 iS PZ/S 1 x # 1x154; 1 x # 2x154
⊕	KK 67 i TORX® 1 x TX 10x154
⊕	KK 67 iS 1 x TX 15x154; 1 x TX 20x154; 1 x TX 25x154 TORX®
●	KK 60 i 1 x 0,4x2,5x154
●	KK 60 iS 1 x 0,6x3,5x154; 1 x 0,8x4,0x154; 1 x 1,0x5,5x154
●	247 1 x 0,5x3,0x70

Product not available in the USA and Canada.

Kraftform Kompakt VDE 7 Universal 1



1 Kraftform handle 817 VDE for Wera interchangeable blades only
VDE interchangeable blades (each 154 mm long)
7-piece set

05003470001	
●	817 VDE 1 x 9x102
+	KK 62 i 1 x PH 1x154; 1 x PH 2x154
◐	KK 60 i 1 x 0,4x2,5x154; 1 x 0,6x3,5x154; 1 x 0,8x4,0x154; 1 x 1,0x5,5x154

Kraftform Kompakt VDE 7 Universal 2



1 Kraftform handle 817 VDE for Wera interchangeable blades only
VDE interchangeable blades (each 154 mm long)
7-piece set

05003472001	
●	817 VDE 1 x 9x102
+	KK 65 i PZ 1 x PZ 1x154; 1 x PZ 2x154
◐	KK 60 i 1 x 0,4x2,5x154; 1 x 0,6x3,5x154; 1 x 0,8x4,0x154; 1 x 1,0x5,5x154

Kraftform Kompakt VDE 7 Imperial 1



1 Kraftform handle 817 VDE for Wera VDE interchangeable blades only
VDE interchangeable blades (each 154 mm long)
7-piece set

05003473001	
●	817 VDE 1 x 9x102
+	KK 62 i 1 x PH 1x154; 1 x PH 2x154
◐	KK 60 i 1 x 0,6x3,5x154; 1 x 1,0x5,5x154
□	KK 68 i 1 x # 1x154; 1 x # 2x154



Kraftform Kompakt VDE

Versatile tools for work on live wiring

Series 7400 VDE Kraftform adjustable torque handle (0.3-3.5 Nm)



Application: For Wera interchangeable Kraftform Kompakt VDE blades only

Accuracy: ±6 % (DIN EN ISO 6789). Numerical torque value scale, audible excess-load signal

Handle: Kraftform with non-roll feature, multi-component

		mm	Nm	Nm	mm	mm
05074752001	7440 VDE	9	0,3-1,2	0,05	192	7 ⁹ / ₁₆ "
05074750001	7441 VDE	9	1,2-3,0	0,10	192	7 ⁹ / ₁₆ "
05074757001	7444 VDE	9	1,7-3,5	0,10	192	7 ⁹ / ₁₆ "

817 VDE Kraftform blade-holding handle



Application: For Wera interchangeable VDE blades only

Handle: Kraftform with non-roll feature, multi-component

	mm	mm
05003990001	9	102

Kraftform Kompakt VDE 60 i



Application: Slotted screws

Blade: Insulated, individually tested as per IEC 60900

Drive: 9 mm hexagonal with entry chamfer

Design: Conical blade, zinc-phosphated, Black Point

	mm	mm	mm	mm	mm
05003400001	0,4	2,5	154	³ / ₃₂ "	6 ¹ / ₁₆ "
05003401001	0,5	3,0	154	¹ / ₈ "	6 ¹ / ₁₆ "
05003402001	0,6	3,5	154	⁹ / ₆₄ "	6 ¹ / ₁₆ "
05003403001	0,8	4,0	154	⁵ / ₃₂ "	6 ¹ / ₁₆ "
05003404001	1,0	5,5	154	⁷ / ₃₂ "	6 ¹ / ₁₆ "
05003405001	1,2	6,5	154	¹ / ₄ "	6 ¹ / ₁₆ "

Kraftform Kompakt VDE 60 iS



Application: Slotted screws

Blade: Reduced blade diameter with integrated protective insulation, allows sunken screws and spring elements to be accessed and actuated, individually tested as per IEC 60900

Drive: 9 mm hexagonal with entry chamfer

Design: Conical blade, zinc-phosphated, Black Point

	mm	mm	mm	mm	mm
05003406001	0,6	3,5	154	⁹ / ₆₄ "	6 ¹ / ₁₆ "
05003407001	0,8	4,0	154	⁵ / ₃₂ "	6 ¹ / ₁₆ "
05003408001	1,0	5,5	154	⁷ / ₃₂ "	6 ¹ / ₁₆ "

Kraftform Kompakt VDE 62 i



Application: Phillips screws

Blade: Insulated, individually tested as per IEC 60900

Drive: 9 mm hexagonal with entry chamfer

Design: Zinc-phosphated, Black Point

		mm	mm
05003410001	PH 0	154	6 ¹ / ₁₆ "
05003411001	PH 1	154	6 ¹ / ₁₆ "
05003412001	PH 2	154	6 ¹ / ₁₆ "

Kraftform Kompakt VDE 62 iS



- Application:** Phillips screws
- Blade:** Reduced blade diameter with integrated protective insulation, allows sunken PH screws to be accessed and actuated, individually tested as per IEC 60900
- Drive:** 9 mm hexagonal with entry chamfer
- Design:** Zinc-phosphated, Black Point

	+	mm	mm
05003413001	PH 1	154	6 1/16"
05003414001	PH 2	154	6 1/16"

Kraftform Kompakt VDE 65 i



- Application:** Pozidriv screws
- Blade:** Insulated, individually tested as per IEC 60900
- Drive:** 9 mm hexagonal with entry chamfer
- Design:** Zinc-phosphated, Black Point

	+	mm	mm
05003450001	PZ 0	154	6 1/16"
05003451001	PZ 1	154	6 1/16"
05003452001	PZ 2	154	6 1/16"

Kraftform Kompakt VDE 65 iS



- Application:** Pozidriv screws
- Blade:** Reduced blade diameter with integrated protective insulation, allows sunken PZ screws to be accessed and actuated, individually tested as per IEC 60900
- Drive:** 9 mm hexagonal with entry chamfer
- Design:** Zinc-phosphated, Black Point

	+	mm	mm
05003455001	PZ 1	154	6 1/16"
05003456001	PZ 2	154	6 1/16"

Tip



Kraftform VDE adjustable torque handle



Simple setting of the required torque by hand.

Easy-to-read scale value. Measurement accuracy is $\pm 6\%$ in accordance with the standard EN ISO 6789.

Distinctly audible and noticeable excess-load signal when the pre-set torque is reached.

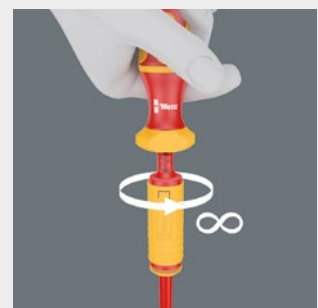
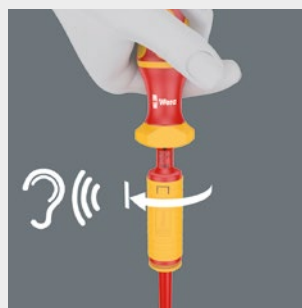
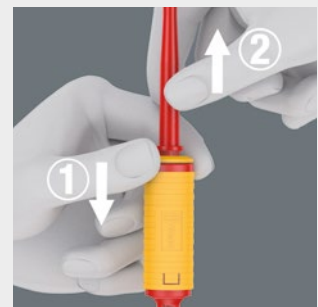
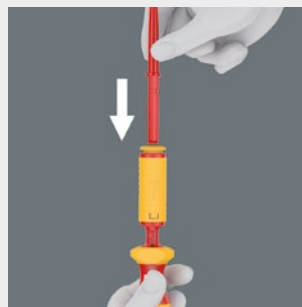



Kraftform Kompakt VDE

Versatile tools for work on live wiring

Kraftform Kompakt VDE 62 i PH/S





- Application:** PlusMinus screws, slotted/Phillips
Blade: Insulated, individually tested as per IEC 60900
Drive: 9 mm hexagonal with entry chamfer
Design: PlusMinus, slotted/Phillips, zinc-phosphated, Black Point

		 mm	
05003440001	# 1	154	6 1/16"
05003441001	# 2	154	6 1/16"

Kraftform Kompakt VDE 62 iS PH/S





- Application:** PlusMinus screws, slotted/Phillips
Blade: Reduced blade diameter with integrated protective insulation, allows sunken PlusMinus screws to be accessed and actuated, individually tested as per IEC 60900
Drive: 9 mm hexagonal with entry chamfer
Design: PlusMinus, slotted/Phillips, zinc-phosphated, Black Point

		 mm	
05003442001	# 1	154	6 1/16"
05003443001	# 2	154	6 1/16"

Kraftform Kompakt VDE 65 i PZ/S





- Application:** PlusMinus screws, slotted/Pozidriv
Blade: Insulated, individually tested as per IEC 60900
Drive: 9 mm hexagonal with entry chamfer
Design: PlusMinus, slotted/Pozidriv, zinc-phosphated, Black Point

		 mm	
05003445001	# 1	154	6 1/16"
05003446001	# 2	154	6 1/16"

Kraftform Kompakt VDE 65 iS PZ/S





- Application:** PlusMinus screws, slotted/Pozidriv
Blade: Reduced blade diameter with integrated protective insulation, allows sunken PlusMinus screws to be accessed and actuated, individually tested as per IEC 60900
Drive: 9 mm hexagonal with entry chamfer
Design: PlusMinus, slotted/Pozidriv, zinc-phosphated, Black Point

		 mm	
05003447001	# 1	154	6 1/16"
05003448001	# 2	154	6 1/16"

Kraftform Kompakt VDE 67 i TORX®



- Application:** TORX® socket screws
Blade: Insulated, individually tested as per IEC 60900
Drive: 9 mm hexagonal with entry chamfer
Design: Zinc-phosphated, Black Point

		 mm	
05003429001 ¹⁾	TX 8	154	6 1/16"
05003430001	TX 9	154	6 1/16"
05003431001	TX 10	154	6 1/16"
05003432001	TX 15	154	6 1/16"
05003433001	TX 20	154	6 1/16"
05003434001	TX 25	154	6 1/16"
05003435001	TX 27	154	6 1/16"
05003436001	TX 30	154	6 1/16"

¹⁾ available from May 2018

Kraftform Kompakt VDE 67 iS TORX®



Application: TORX® socket screws

Blade: Reduced blade diameter with integrated protective insulation, allows sunken TORX® socket screws to be accessed and actuated, individually tested as per IEC 60900

Drive: 9 mm hexagonal with entry chamfer

Design: Zinc-phosphated, Black Point

		 mm	 "
05003437001	TX 15	154	6 1/16"
05003438001	TX 20	154	6 1/16"
05003439001	TX 25	154	6 1/16"

Kraftform Kompakt VDE 68 i



Application: Square socket head screws

Blade: Insulated, individually tested as per IEC 60900

Drive: 9 mm hexagonal with entry chamfer

Design: Zinc-phosphated, Black Point

		 mm	 "
05003415001	# 1	154	6 1/16"
05003416001	# 2	154	6 1/16"

Kraftform Kompakt VDE 68 iS



Application: Square socket head screws

Blade: Reduced blade diameter with integrated protective insulation, allows sunken square socket head screws to be accessed and actuated, individually tested as per IEC 60900

Drive: 9 mm hexagonal with entry chamfer

Design: Zinc-phosphated, Black Point

		 mm	 "
05003417001	# 1	154	6 1/16"
05003418001	# 2	154	6 1/16"

Kraftform Kompakt VDE 64 i



Application: Hexagon socket screws

Blade: Insulated, individually tested as per IEC 60900

Drive: 9 mm hexagonal with entry chamfer

Design: Zinc-phosphated, Black Point

	 mm	 mm	 "
05003420001	2,5	154	6 1/16"
05003421001	3,0	154	6 1/16"
05003422001	4,0	154	6 1/16"
05003423001	5,0	154	6 1/16"
05003424001	6,0	154	6 1/16"







Kraftform Kompakt VDE

Versatile tools for work on live wiring

Kraftform Kompakt 96 VK 6,3





Switch cabinet key, 6.3 mm, glass-fibre reinforced

				
05003460001	mm	mm		
	6,3	89	3 ⁹ / ₁₆ "	

Kraftform Kompakt 99 FL







Switch cabinet key, glass-fibre reinforced

			
05003463001		mm	
		89	3 ⁹ / ₁₆ "

Kraftform Kompakt 97 VK 8,1





Switch cabinet key, 8.1 mm, glass-fibre reinforced

				
05003461001	mm	mm		
	8,1	89	3 ⁹ / ₁₆ "	

Kraftform Kompakt 98 DK



Switch cabinet key, glass-fibre reinforced

			
05003462001		mm	
		89	3 ⁹ / ₁₆ "



Kraftform Comfort VDE Screwdrivers

The ergonomic introduction to convenient screwdriving.

Handle with Kraftform geometry and blade made from power bit material with Black Point tip for precise fit – and they are even VDE-tested, too.



Multi-component Kraftform handle, for quick and low-exertion working.

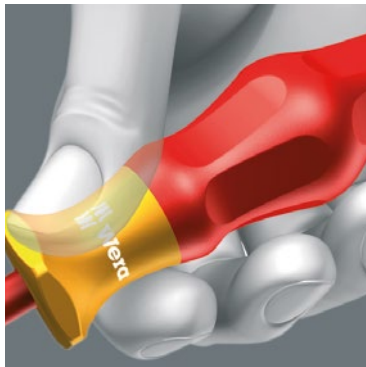

Screw symbol and tip size identification markings on the handle make it easier to find the right screwdriver in the tool case or at the workplace.



Hexagonal non-roll feature prevents any annoying rolling away at the workplace.

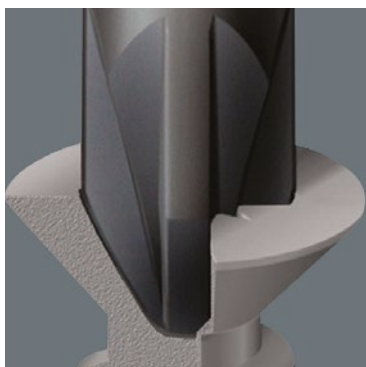
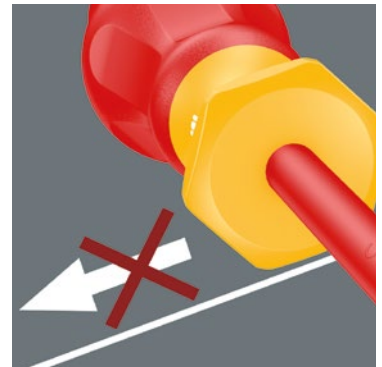

Wera Black Point tips and a refined hardening process ensure long service life of the tip, improved corrosion protection and an exact fit.



The individual testing at 10,000 volts, in accordance with IEC 60900, ensures safe working with loads up to 1,000 volts.

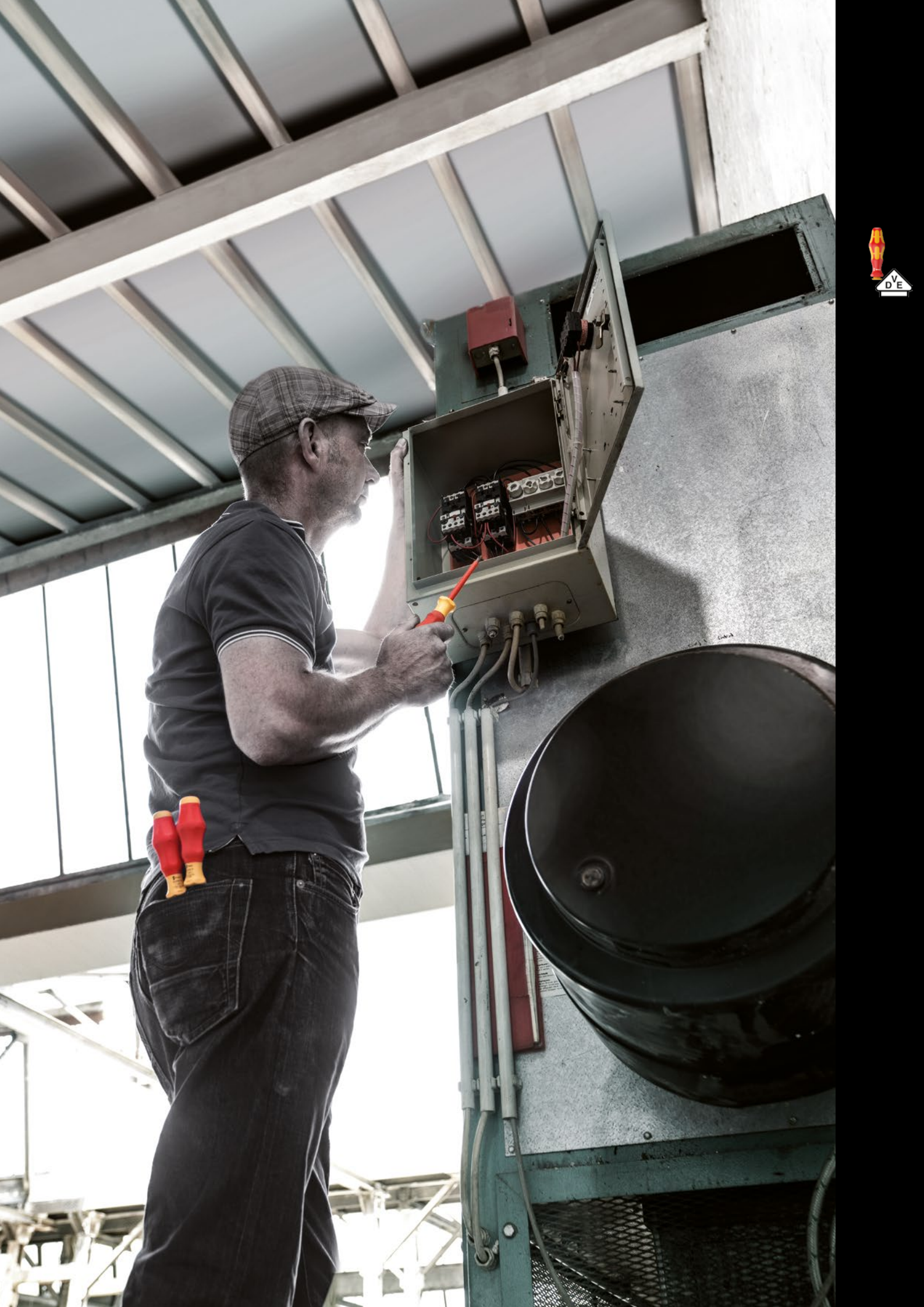

Kraftform Comfort VDE

Convenient, safe, good!

1160 i VDE Insulated screwdriver for slotted screws









Application: Slotted screws

Blade: Insulated, individually tested as per IEC 60900

Design: Conical tip, chrome-plated, Black Point

Handle: Kraftform Comfort with non-roll feature, multi-component

						
	mm	mm	mm	mm	"	"
05031580001	0,4	2,5	80	81	3/32"	3 1/8"
05031581001	0,5	3,0	100	81	1/8"	4"
05031582001	0,6	3,5	100	81	9/64"	4"
05031583001	0,8	4,0	100	98	5/32"	4"
05031584001	0,8	4,0	150	98	5/32"	6"
05031587001	1,0	5,5	125	98	7/32"	5"
05031585001	1,0	5,5	200	98	7/32"	8"
05031588001	1,2	6,5	150	105	1/4"	6"
05031589001	1,2	8,0	175	112	5/16"	7"

1162 i PH VDE Insulated screwdriver for Phillips screws







Application: Phillips screws

Blade: Insulated, individually tested as per IEC 60900

Design: Chrome-plated, Black Point

Handle: Kraftform Comfort with non-roll feature, multi-component

				
		mm	mm	"
05031600001	PH 0	80	81	3 1/8"
05031601001	PH 1	80	98	3 1/8"
05031602001	PH 1	150	98	6"
05031603001	PH 2	100	105	4"
05031604001	PH 2	200	105	8"
05031605001	PH 3	150	112	6"

1165 i PZ VDE Insulated screwdriver for Pozidriv screws





Application: Suitable for Pozidriv screws

Blade: Insulated, individually tested as per IEC 60900

Design: Chrome-plated, Black Point

Handle: Kraftform Comfort with non-roll feature, multi-component





				
		mm	mm	"
05031610001	PZ 0	80	81	3 1/8"
05031611001	PZ 1	80	98	3 1/8"
05031613001	PZ 2	100	105	4"
05031615001	PZ 3	150	112	6"

1160 i/7 Safety screwdriver set Kraftform Comfort VDE and voltage tester



Application: Slotted and Phillips screws

Content: 7-piece set in display carton

05031575001		
		1162 i PH VDE 1 x PH 1x80; 1 x PH 2x100
		1160 i VDE 1 x 0,4x2,5x80; 1 x 0,6x3,5x100; 1 x 0,8x4,0x100; 1 x 1,0x5,5x125
		4115 1 x 0,5x3,0x65

Product not available in the USA and Canada.

1160 i/1165 i/7 Screwdriver set Kraftform Comfort VDE and voltage tester



Application: Slotted and Pozidriv screws

Content: 7-piece set in display carton

05031576001	
+	1165 i PZ VDE 1 x PZ 1x80; 1 x PZ 2x100
-	1160 i VDE 1 x 0,4x2,5x80; 1 x 0,6x3,5x100; 1 x 0,8x4,0x100; 1 x 1,0x5,5x125
-	4115 1 x 0,5x3,0x65

Product not available in the USA and Canada.



Zyklop VDE series

We want users of our tools to work safely and comfortably.

The Zyklop VDE ratchet and matching accessories are the right tools for safe working on electrical systems and impress by their advantages even when used in tight conditions.



The individual testing at 10,000 volts, in accordance with IEC 60900, ensures safe working with loads up to 1,000 volts.



The Zyklop VDE sockets and extensions offer increased safety thanks to their 2-component isolation with yellow insulation core under red insulation outer layer.



The ball lock ensures a secure fit of the sockets and accessories and thus also for increased safety during operation. A short press on the release button and the tool can be changed.

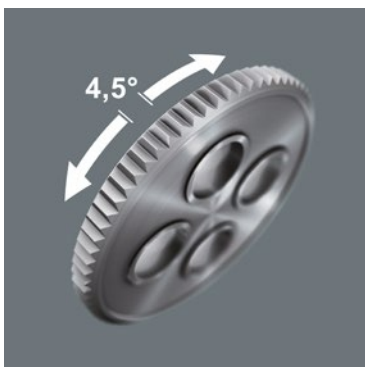

The Zyklop VDE ratchet allows a short return angle of only 4.5° thanks to its 80 teeth.



The extremely slim design of the Zyklop VDE ratchet makes it easy to work even in confined spaces.



The reversing lever ensures a comfortable change of direction.



Zyklop VDE ratchet and accessories

Every piece is safety tested

8007 B VDE Zyklop VDE Ratchet with switch lever and $\frac{3}{8}$ " drive

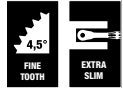

Application: $\frac{3}{8}$ " square sockets as well as for $\frac{3}{8}$ " adaptors with square drive, with ball locking device

Design: Individually tested as per IEC 60900 at 10,000V for safe working at the approved voltage of 1,000V; slim design to enable work in very confined spaces; fine-tooth mechanism with 80 teeth for a return angle of only 4.5°; switch lever for convenient change of direction; secure socket locking function by push button

		$\frac{3}{8}$ "	222,0
05004966001		$\frac{3}{8}$ "	222,0

8790 B VDE Zyklop $\frac{3}{8}$ " socket



Application: Hexagon headed bolts, screws and nuts

Design: Insulated, individually tested as per IEC 60900. Increased safety due to 2-component insulation with yellow insulation core, which becomes visible in case of damage to the outer red VDE insulation layer.

	mm	mm	mm	mm
05004950001	6,0	46,0	14,8	23,0
05004951001	7,0	46,0	15,7	23,0
05004952001	8,0	46,0	17,0	23,0
05004953001	9,0	46,0	18,2	23,0
05004954001	10,0	46,0	19,4	23,0
05004955001	11,0	46,0	20,7	23,0
05004956001	12,0	46,0	23,0	23,0
05004957001	13,0	46,0	23,0	23,0
05004958001	14,0	46,0	24,7	23,0
05004959001	15,0	46,0	26,0	23,0
05004960001	16,0	46,0	26,8	23,0
05004961001	17,0	46,0	29,0	23,0
05004962001	18,0	46,0	29,6	23,0
05004963001	19,0	46,0	30,7	23,0



Schütter
Elektro-Service



Zyklop VDE ratchet and accessories

Every piece is safety tested

8794 LB VDE Zyklop extension, long, $\frac{3}{8}$ "



Application: For VDE insulated $\frac{3}{8}$ " square drive sockets with ball lock

Design: Insulated, individually tested as per IEC 60900. Increased safety due to 2-component insulation with yellow insulation core under red isolation outer insulating outer layer



		$\frac{3}{8}$ "	166,0
05004965001			

8794 SB VDE Zyklop extension, short, $\frac{3}{8}$ "



Application: For VDE insulated $\frac{3}{8}$ " square drive sockets with ball lock

Design: Insulated, individually tested as per IEC 60900. Increased safety due to 2-component insulation with yellow insulation core, which becomes visible in case of damage to the outer red VDE insulation layer.

			
		$\frac{3}{8}$ "	91,0
05004964001			



8100 SB VDE 1 Zyklop Ratchet Set with switch lever, 3/8" drive, metric



17 pieces; in a surface-preserving, compact and extremely robust textile box; low volume and weight for simplified mobility. Fleece backing and hook and loop fastener system for easy attachment, e. g. on wall, shelf, workshop trolley and the Wera 2go tool transport system. Smooth rotating mechanism for safe storage and easy removal of the Zyklop VDE sockets.

1 Zyklop Ratchet 8007 B VDE, with switch lever, with 3/8" drive, 14 Zyklop VDE sockets, 2 Zyklop VDE extensions, one long, one short, all tools insulated, individually tested as per IEC 60900 at 10,000 V for safe working at the approved voltage of 1,000 V. The Zyklop VDE sockets and extensions offer increased safety through 2-component isolation with yellow insulation core, which becomes visible in case of damage to the outer red VDE insulation layer.

	
05004970001	
⊙	8007 B VDE 1 x 3/8"x222,0
●	8790 B VDE 1 x 6,0x46,0; 1 x 7,0x46,0; 1 x 8,0x46,0; 1 x 9,0x46,0; 1 x 10,0x46,0; 1 x 11,0x46,0; 1 x 12,0x46,0; 1 x 13,0x46,0; 1 x 14,0x46,0; 1 x 15,0x46,0; 1 x 16,0x46,0; 1 x 17,0x46,0; 1 x 18,0x46,0; 1 x 19,0x46,0
⊙	8794 SB VDE 1 x 3/8"x91,0
⊙	8794 LB VDE 1 x 3/8"x166,0

Tip

Compatible with Wera 2go



The textile box of the ratchet set 8100 SB VDE 1 is suitable for attachment to wall, shelf, workshop trolley and the Wera 2go system thanks to its hook and loop fastener system on the back.



Increased security



The Zyklop VDE sockets and extensions offer increased safety thanks to their 2-component isolation with yellow insulation core under red insulation outer layer.



Ratchets

The Zyklop Ratchets, 1/4"



Zyklop Speed

Zyklop Metal Push

Zyklop Metal Switch

Zyklop Accessories

144

152

154

156

The Zyklop Ratchets, 3/8"



Zyklop Speed

Zyklop Metal Push

Zyklop Metal Switch

Zyklop Accessories

172

176

178

180

The Zyklop Ratchets, 1/2"



Zyklop Speed

Zyklop Hybrid

Zyklop Metal Push

Zyklop Metal Switch

Zyklop Accessories

190

194

198

200

202

1/2" Koloss ratchet with hammer function



210

Zyklop Mini 1 & 2



214

Wera ratchets

We simply could not believe that it was not possible to improve on existing standards for ratchets.

We took up the challenges confronting users when working with ratchets. Mostly, it is a question of working speed, confined working space and diverse functionality.

We did a lot of research, until we finally came up with suitable problem solutions that we can offer across the entire range.



The Zyklop Speed Ratchet

The Wera Zyklop Speed ratchet combines the advantages of five different types of ratchet in one. And it is a really fast mover.

The Zyklop Hybrid Ratchet

Combines robustness, slim design, and little weight.

The Zyklop Ratchet Metal Push

Extremely slim. Long leverage. With push-through square.



The Zyklop Ratchet Metal Switch

Extremely slim. Long leverage. With switch lever.



The Koloss Ratchet

The heavy-duty ratchet that can also be safely used as a hammer.



The Zyklop Mini Ratchets

For all difficult-to-access applications.



Zyklop Speed ratchet

We just could not believe that it was not possible to make a ratchet work more quickly. Moreover, we did not like the way users had to apply many different types of ratchet to get a job done. We therefore questioned everything that was conventional about ratchets. The Zyklop Speed ratchet is what has emerged. The flywheel design of the Zyklop Speed ensures high working speeds. And: the Zyklop Speed combines the advantages of 5 types of ratchet in a single tool. Additionally, it can be used as a screwdriver.



The ratchet head pivots freely and can be locked into any position by using the slide switch that is positioned on either side. It is even possible to work in very confined and difficult-to-access areas with enhanced hand clearance. The pre-defined locking at 0°, 15° and 90°, both to the right and left, ensure safe working without any slipping of the ratchet head.

The Zyklop Speed ratchets are really fast movers. The gyrating mass design means that screwdriving is accelerated. The rotation-symmetric structure of the Kraftform handle and the free-turning sleeve reinforce this rapid twisting process, particularly when the ratchet does not engage due to too little resistance in the thread.



The outstanding design of the Kraftform handle fits perfectly into the hand, preventing hand injuries such as blisters and calluses. The hard materials used for the handle ensure quick and easy hand repositioning without any danger of the skin “sticking” to the handle, whilst the softer “anti-slip” zones enable the low-loss transfer of high forces – resulting in less screwdriving effort being required. The circular handle design allows rapid turning in the 0° position.



All Zyklop Speed ratchets feature a thumbwheel that can be used to quickly and easily switch between clockwise and anticlockwise rotation, at any position. No complicated handling, no loss of time!

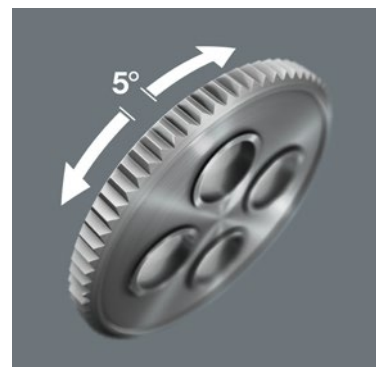

The reversible ratchet with 72 fine-pitched teeth has a low return angle of only 5°. This short stroke allows fast and precise work in all types of installation.

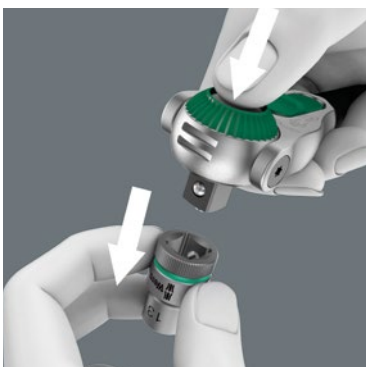

The ball lock holds the sockets and attachments securely, ensuring safe working. A changeover into any predefined position is completed by simply pressing the release button – this is even the case in the 90° position.



The ratchet head has an ergonomic design with finger recesses that offer a perfect contact surface for the hand or fingers to turn the head.



The ratchet can be used as a conventional screwdriver in the 0° position by attaching a bitholding adaptor and a bit.

Zyklop Hybrid ratchet

We wanted to integrate all the mostly-desired ratchet advantages in a single tool. Our idea was to develop a light ratchet with an ergonomic handle, slim design, long lever and an extension option.

Since the term “hybrid” refers to a combination from various sectors, it was quite easy to decide on the name.



The reversible ratchet with 72 finepitched teeth has a low return angle of only 5°. This short stroke allows fast and precise work in all types of installation.



The ball lock holds the sockets and attachments securely, ensuring safe working.



Multi-component Kraftform handle for optimum pressure and tensile loads.



Very slim ratchet head.



Larger overall length for higher torque transfer.



Even more torque can be applied by using the extension.



Zyklop Metal ratchet

Due to the ever-more confined working environment, space is becoming more and more an issue for the application of ratchets. Our product developers therefore intensively occupied themselves with the issue of confined working spaces, and Wera has now solved this problem.

The extremely slim and robust Zyklop Metal ratchet with a long lever was what emerged. When the change in direction needs to be quick, the Zyklop Metal Switch ratchet is the right tool.

When the socket must not get lost and a coincidental change of direction has to be avoided at all cost, the Zyklop Metal Push is the correct choice.



Forged, full metal ratchet (chrome-molybdenum) that is extremely robust with a long service life; slim design to enable work in very confined spaces.



Zyklop Metal Push

Smooth push-through mechanism, that cannot get lost.

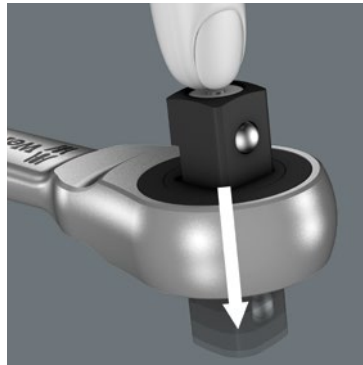

Zyklop Metal Push

The dual-ratchet-teeth design means that a 76 fine-toothing division can be achieved from the 38 robust teeth with a return angle of only 4.7°.

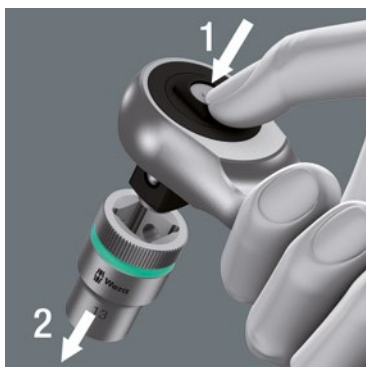
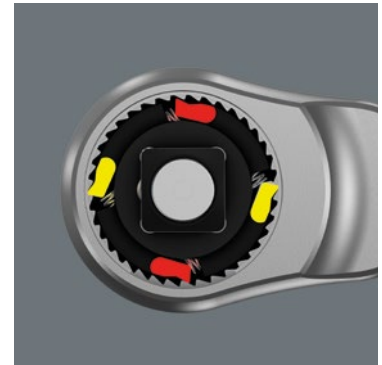

The ball lock holds the sockets and attachments securely, ensuring safe working.



Zyklop Metal Switch
Switch lever for convenient change of direction.



Zyklop Metal Switch
Fine-tooth mechanism with 72 teeth for a return angle of only 5°. This short stroke allows fast and precise work in all types of installation.

Zyklop Accessories

We did not just want our creativity to end with the ratchets themselves so we also occupied ourselves intensively with ratchet accessories. That is why our users are now provided with an extension with freely spinning sleeve and flexible lock to enable more secure and more rapid screwdriving.

The sockets have been completely redesigned: we wanted to spare the user the need of having two different series – one for manual and the other for power tool applications.

And: we wanted to enormous simplify the task of finding the right sizes. Technically, our own ambitious goals represented a real challenge: to endow sockets with the advantage of the holding function on screwdrivers and bits. We succeeded in this!



“Take it easy” tool finder system - with profile and size colour-coding for quick and easy tool selection. Colour-coded system for hexagon drive screws (L-Keys, Zyklop bit sockets), external hex drive screws and nuts (Joker wrenches, Zyklop sockets and Zyklop bit sockets with holding function), and TORX® drive screws (L-Keys, Zyklop bit sockets).



The manual and machine sockets can be used both for hand and power tools use (non-impact). Users need just one socket set for all applications.



Zyklop sockets and bit sockets with holding function securely hold the screw on the tool. This is particularly helpful in difficult-to-access working spaces where the second hand cannot be used to hold the screw.

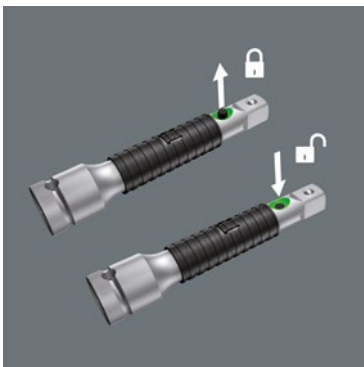

The extensions from the premium lines are also equipped with the unique “flexible-lock-system”. By activating this system, attachments can be fixed to the extension permanently – preventing slipping and any unintentional loss of the attachment. When the system is deactivated, the sockets can be attached as usual and changed in a flash.







The free-turning sleeve on the Zyklop Speed and the Zyklop extension effectively accelerates the turning of screws and nuts.



Typically Wera designed robust textile belt. A smooth Twist to Unlock mechanism ensures a secure fit and simple removal of the sockets. Includes a snap hook for secure fastening to a belt loop or pocket. Supplied with a non-woven reverse side and hook and loop strips for simple attachment e.g. to a wall, shelf, tool trolley and to the Wera 2go tool transport system.



Zyklop Ratchets, 1/4"

	Zyklop Speed	144
	Zyklop Metal Push	152
	Zyklop Metal Switch	154
	Zyklop Accessories	156



The Zyklop Speed Ratchets, 1/4"

Combine 5 types of ratchet

8100 SA All-in Zyklop Speed Ratchet Set, 1/4" drive, with holding function, metric

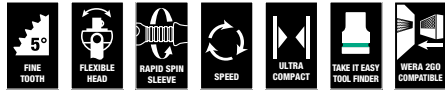

42-piece set; in a surface-preserving, compact and extremely robust textile box; low volume and weight for simplified mobility. Non-woven reverse side and hook and loop strips for simple attachment e.g. to a wall, shelf, tool trolley and to the Wera 2go tool transport system. Fast and easy Twist to Unlock mechanism for secure storage and simple removal of the sockets.

1 Zyklop Speed Ratchet with 1/4" drive, 13 Zyklop sockets with 1/4" drive with fastener holding function, 9 Zyklop bit sockets for TORX® screws, with 1/4" drive, with holding function, 8 bit sockets for hexagon socket screws with 1/4" drive with holding function (sizes 2.0 and 2.5 without holding function) and Hex-Plus high torque geometry, 3 Zyklop bit sockets with 1/4" drive for Phillips screws, 3 Zyklop bit sockets with 1/4" drive for Pozidriv screws, 2 Zyklop bit sockets with 1/4" drive for slotted screws, Take it easy tool finder: Colour coding to enable the desired bit socket to be easily selected, 1 tool for the simple removal of nuts from sockets with holding function, 1 Zyklop extension (long) with free-turning sleeve, 1 wobble extension.

05003755001	
⊖	8000 A 1 x 1/4"x152,0
⊙	8796 LA 1 x 1/4"x150,0
⊙	8794 A 1 x 1/4"x56,0
⊙	8790 HMA HF 1 x 4,0x23,0; 1 x 4,5x23,0; 1 x 5,0x23,0; 1 x 5,5x23,0; 1 x 6,0x23,0; 1 x 7,0x23,0; 1 x 8,0x23,0; 1 x 9,0x23,0; 1 x 10,0x23,0; 1 x 11,0x23,0; 1 x 12,0x23,0; 1 x 13,0x23,0; 1 x 14,0x23,0
⊕	8767 A HF 1 x TX 8x28,0; 1 x TX 9x28,0; 1 x TX 10x28,0; 1 x TX 15x28,0; 1 x TX 20x28,0; 1 x TX 25x28,0; 1 x TX 27x28,0; 1 x TX 30x28,0; 1 x TX 40x28,0
○	8740 A 1 x 2,0x28,0; 1 x 2,5x28,0
○	8740 A HF 1 x 3,0x28,0; 1 x 4,0x28,0; 1 x 5,0x28,0; 1 x 6,0x28,0; 1 x 7,0x28,0; 1 x 8,0x28,0
⊕	8751 A 1 x PH 1x28,0; 1 x PH 2x28,0; 1 x PH 3x28,0
⊕	8755 A 1 x PZ 1x28,0; 1 x PZ 2x28,0; 1 x PZ 3x28,0
⊖	8700 A FL 1 x 0,8x5,5x28,0; 1 x 1,2x6,5x28,0
	Nut Extractor 1 x 14,0x43,0

8100 SA 6 Zyklop Speed Ratchet Set, 1/4" drive, metric

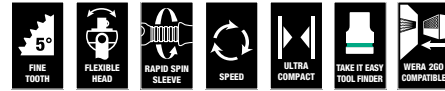

28-piece set; in a surface-preserving, compact and extremely robust textile box; low volume and weight for simplified mobility

1 Zyklop Speed Ratchet with 1/4" drive, 9 Zyklop sockets, 1 Zyklop extension (long) with free-turning sleeve, 1 wobble extension, 1 adaptor with quick-release chuck, 15 bits

05004016001	
⊖	8000 A 1 x 1/4"x152,0
⊙	8790 HMA 1 x 5,0x23,0; 1 x 5,5x23,0; 1 x 6,0x23,0; 1 x 7,0x23,0; 1 x 8,0x23,0; 1 x 10,0x23,0; 1 x 11,0x23,0; 1 x 12,0x23,0; 1 x 13,0x23,0
⊙	8794 LA 1 x 1/4"x150,0
⊙	8794 A 1 x 1/4"x56,0
⊙	8784 A1 1 x 1/4"x1/4"x37,0
⊕	851/4 TZ PH 1 x PH 1x50; 1 x PH 2x50; 1 x PH 3x50
⊕	855/4 TZ PZ 1 x PZ 1x50; 1 x PZ 2x50
⊕	867/4 Z TORX® 1 x TX 10x50; 1 x TX 15x50; 1 x TX 20x50; 1 x TX 25x50; 1 x TX 27x50; 1 x TX 30x50
○	840/4 Z 1 x 3,0x50; 1 x 4,0x50; 1 x 5,0x50; 1 x 6,0x50
	Hex-Plus

8100 SA 9 Zyklop Speed Ratchet Set, 1/4" drive, imperial

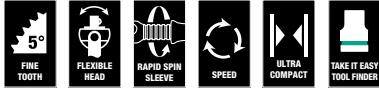

28-piece set; in a surface-preserving, compact and extremely robust textile box; low volume and weight for simplified mobility

1 Zyklop Speed Ratchet with 1/4" drive, 9 Zyklop sockets, 1 Zyklop extension (long) with free-turning sleeve, 1 wobble extension, 1 adaptor with quick-release chuck, 15 bits

05004019001		
⊙	8000 A	1 x 1/4"x152,0
⊙	8790 HMA	1 x 3/16"x23,0; 1 x 7/32"x23,0; 1 x 1/4"x23,0; 1 x 9/32"x23,0; 1 x 5/16"x23,0; 1 x 11/32"x23,0; 1 x 3/8"x23,0; 1 x 7/16"x23,0; 1 x 1/2"x23,0
⊙	8794 LA	1 x 1/4"x150,0
⊙	8794 A	1 x 1/4"x56,0
⊙	8784 A1	1 x 1/4"x1/4"x37,0
+	851/4 TZ PH	1 x PH 1x50; 1 x PH 2x50; 1 x PH 3x50
+	855/4 TZ PZ	1 x PZ 1x50; 1 x PZ 2x50
+	867/4 Z TORX®	1 x TX 10x50; 1 x TX 15x50; 1 x TX 20x50; 1 x TX 25x50; 1 x TX 27x50; 1 x TX 30x50
⊙	840/4 Z Hex-Plus	1 x 5/32"x50; 1 x 3/16"x50; 1 x 7/32"x50; 1 x 1/4"x50

Tip

Zyklop "6 in 1"



1. Fine-tooth ratchet
2. Flex-head ratchet
3. Angle ratchet
4. Quick-release ratchet
5. Power ratchet
6. Screwdriver

New set concept



The textile boxes offer dramatically improved portability, and are space-saving to boot! This means you can now carry the same collection of tools, in a much more compact and comfortable package.



The hassle of running back and forth for the right tools has now become a thing of the past. And the much lower weight of a set makes carrying more convenient than ever before. The textile box including the tool will even survive a fall undamaged.



"Take it easy"



"Take it easy" tool finder system – with profile and size colour-coding for quick and easy tool selection. Colour-coded system for hexagon drive screws (L-Keys, Zyklop bit sockets), external hex drive screws and nuts (Joker wrenches, Zyklop sockets and Zyklop bit sockets with holding function), and TORX® drive screws (L-Keys, Zyklop bit sockets).

The Zyklop Speed Ratchets, 1/4"

Combine 5 types of ratchet

Kraftform Kompakt Zyklop MS1 Metal/Speed 1/4"



8-piece set; in surface-protecting, compact textile box, highly robust; low volume and weight for simplified mobility.

1 Zyklop Speed ratchet with 1/4" drive, 1 Zyklop Metal ratchet with switch lever and 1/4" drive, 1 Zyklop extension (long) with rapid spin sleeve and "flexible-lock" system, 2 Zyklop extensions (short and long) with rapid spin sleeve, 1 adaptor with rapid change chuck, 1 wobble extension, 1 universal joint.

05135949001		
○	8000 A	1 x 1/4"x152,0
○	8004 A	1 x 1/4"x141,0
⊗	8796 LA	1 x 1/4"x150,0
⊗	8794 LA	1 x 1/4"x150,0
⊗	8794 SA	1 x 1/4"x75,0
⊗	8784 A1	1 x 1/4"x1/4"x37,0
⊗	8794 A	1 x 1/4"x56,0
⊗	8795 A	1 x 1/4"x35,5





The Zyklop Speed Ratchets, 1/4"

Combine 5 types of ratchet

8100 SA 2 Zyklop Speed Ratchet Set, 1/4" drive, metric

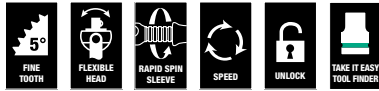

42-piece set in strong metal case

1 Zyklop ratchet with 1/4" drive, 13 Zyklop sockets (metric), 2 Zyklop "flexible-lock" extensions (short and long) with free-turning sleeve, 1 wobble extension, 1 sliding T-handle, 1 universal joint, 1 adaptor with quick-release chuck, 22 bits

05003533001		
⊙	8000 A	1 x 1/4"x152,0
⊙	8790 HMA	1 x 4,0x23,0; 1 x 4,5x23,0; 1 x 5,0x23,0; 1 x 5,5x23,0; 1 x 6,0x23,0; 1 x 7,0x23,0; 1 x 8,0x23,0; 1 x 9,0x23,0; 1 x 10,0x23,0; 1 x 11,0x23,0; 1 x 12,0x23,0; 1 x 13,0x23,0; 1 x 14,0x23,0
⊙	8789 A	1 x 1/4"x110,0
⊙	8794 A	1 x 1/4"x56,0
⊙	8795 A	1 x 1/4"x35,5
⊙	8784 A1	1 x 1/4"x1/4"x37,0
⊙	8796 SA	1 x 1/4"x75,0
⊙	8796 LA	1 x 1/4"x150,0
⊙	840/1 Z Hex-Plus	1 x 3,0x25; 1 x 4,0x25; 1 x 5,0x25; 1 x 6,0x25; 1 x 8,0x25
⊙	867/1 Z TORX® B0	1 x TX 8x25; 1 x TX 9x25; 1 x TX 10x25; 1 x TX 15x25; 1 x TX 20x25; 1 x TX 25x25; 1 x TX 30x25; 1 x TX 40x25
⊙	800/1 Z	1 x 0,6x4,5x25; 1 x 1,0x5,5x25; 1 x 1,2x8,0x25
⊙	851/1 Z PH	1 x PH 1x25; 1 x PH 2x25; 1 x PH 3x25
⊙	855/1 Z PZ	1 x PZ 1x25; 1 x PZ 2x25; 1 x PZ 3x25

8100 SA 4 Zyklop Speed Ratchet Set, 1/4" drive, imperial



41-piece set in strong metal case

1 Zyklop ratchet with 1/4" drive, 10 Zyklop sockets (imperial), 2 Zyklop "flexible-lock" extensions (short and long) with free-turning sleeve, 1 wobble extension, 1 sliding T-handle, 1 universal joint, 1 adaptor with quick-release chuck, 24 bits

05003535001		
⊙	8000 A	1 x 1/4"x152,0
⊙	8790 HMA	1 x 3/16"x23,0; 1 x 7/32"x23,0; 1 x 1/4"x23,0; 1 x 9/32"x23,0; 1 x 5/16"x23,0; 1 x 11/32"x23,0; 1 x 3/8"x23,0; 1 x 7/16"x23,0; 1 x 1/2"x23,0; 1 x 9/16"x23,0
⊙	8789 A	1 x 1/4"x110,0
⊙	8794 A	1 x 1/4"x56,0
⊙	8795 A	1 x 1/4"x35,5
⊙	8784 A1	1 x 1/4"x1/4"x37,0
⊙	8796 SA	1 x 1/4"x75,0
⊙	8796 LA	1 x 1/4"x150,0
⊙	867/1 Z TORX® B0	1 x TX 8x25; 1 x TX 9x25; 1 x TX 10x25; 1 x TX 15x25; 1 x TX 20x25; 1 x TX 25x25; 1 x TX 30x25; 1 x TX 40x25
⊙	800/1 Z	1 x 0,6x4,5x25; 1 x 1,0x5,5x25; 1 x 1,2x8,0x25
⊙	851/1 Z PH	1 x PH 1x25; 1 x PH 2x25; 1 x PH 3x25
⊙	855/1 Z PZ	1 x PZ 1x25; 1 x PZ 2x25; 1 x PZ 3x25
⊙	840/1 Z Hex-Plus	1 x 5/64"x25; 1 x 3/32"x25; 1 x 1/8"x25; 1 x 9/64"x25; 1 x 5/32"x25; 1 x 3/16"x25; 1 x 7/32"x25

8100 SA/SC 2 Zyklop Speed Ratchet Set, 1/4" drive and 1/2" drive, metric

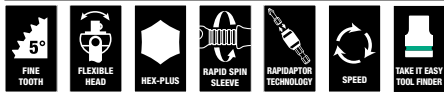

43 piece set, in strong metal case

1 Zyklop ratchet with 1/4" drive, 1 Zyklop ratchet with 1/2" drive, 21 Zyklop sockets (metric), 2 Zyklop "flexible-lock" extensions (long) with freewheel sleeve, 1 adaptor with quick-release chuck, 1 Kraftform bitholding screwdriver with Rapidaptor quick-release chuck, 16 bits

05160785001	
●	8000 A 1 x 1/4"x152,0
●	8790 HMA 1 x 4,0x23,0; 1 x 4,5x23,0; 1 x 5,0x23,0; 1 x 5,5x23,0; 1 x 6,0x23,0; 1 x 7,0x23,0; 1 x 8,0x23,0; 1 x 9,0x23,0; 1 x 10,0x23,0; 1 x 12,0x23,0; 1 x 13,0x23,0
●	8784 A1 1 x 1/4"x1/4"x37,0
●	8796 LA 1 x 1/4"x150,0
●	8000 C 1 x 1/2"x277,0
●	8790 HMC 1 x 13,0x37,0; 1 x 14,0x37,0; 1 x 15,0x37,0; 1 x 16,0x37,0; 1 x 17,0x37,0; 1 x 18,0x37,0; 1 x 19,0x37,0; 1 x 21,0x37,0; 1 x 22,0x37,0; 1 x 24,0x37,0
●	8796 LC 1 x 1/2"x250,0
●	816 R 1 x 1/4"x119
●	800/4 Z 1 x 1,0x5,5x89
●	840/4 Z 1 x 3,0x89; 1 x 4,0x89; 1 x 5,0x89; 1 x 6,0x89 Hex-Plus
+	851/4 Z PH 1 x PH 1x89; 1 x PH 2x89; 1 x PH 3x89
+	855/4 Z PZ 1 x PZ 1x89; 1 x PZ 2x89; 1 x PZ 3x89
+	867/4 Z TORX® 1 x TX 10x89; 1 x TX 15x89; 1 x TX 20x89; BO 1 x TX 25x89; 1 x TX 30x89

Tip

How to notice missing tools more quickly



Perfectly conceived in every detail: the storage case for the Zyklop Speed ratchet sets! The two-tone foam insert section means that the tools can be quickly and reliably replaced, and that missing tools can be detected immediately. The tools and their position can be clearly seen in the lid where they have been laser-etched, ensuring

that they are legible even when the insert section is covered with grease, dirt or oil. Additionally, the foam section can be removed and placed in the drawer of a tool cabinet or trolley.



"Flexible-lock-system"

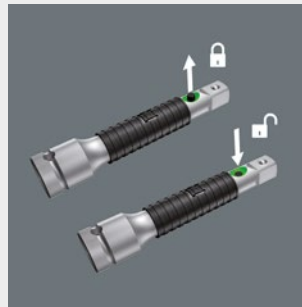

The extensions from the premium lines are also equipped with the unique "flexible-lock-system". By activating this system, attachments can be fixed to the extension permanently – preventing slipping and any unintentional loss of the attachment. When the system is deactivated, the sockets can be attached as usual and changed in a flash.

Is it also possible to reverse the drive with oily hands?



The thumbwheel is designed in such a way that it offers outstanding grip and can, therefore, even be operated with oily fingers.

The Zyklop Speed Ratchets, 1/4"

Combine 5 types of ratchet

Kraftform Kompakt Zyklop Speed

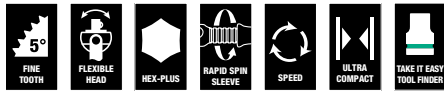

26-piece set in a belt pouch

1 Zyklop Speed ratchet with 1/4" drive, 7 Zyklop sockets (metric), 1 Zyklop extension (long) with free-turning sleeve, 1 adaptor, 16 bits of 50 mm in length

Icon	Part Number	Description
⬤	05051045001	8000 A 1 x 1/4"x152,0
⬤	8784 A1	1 x 1/4"x1/4"x37,0
⬤	8794 LA	1 x 1/4"x150,0
+	851/4 TZ PH	1 x PH 1x50; 1 x PH 2x50; 1 x PH 3x50
+	855/4 TZ PZ	1 x PZ 1x50; 1 x PZ 2x50
+	867/4 Z TORX	1 x TX 10x50; 1 x TX 15x50; 1 x TX 20x50; 1 x TX 25x50; 1 x TX 27x50; 1 x TX 30x50
+	800/4 Z	1 x 1,0x5,5x50
+	840/4 Z Hex-Plus	1 x 3,0x50; 1 x 4,0x50; 1 x 5,0x50; 1 x 6,0x50
+	8790 HMA	1 x 5,5x23,0; 1 x 6,0x23,0; 1 x 7,0x23,0; 1 x 8,0x23,0; 1 x 10,0x23,0; 1 x 12,0x23,0; 1 x 13,0x23,0



” To learn more about this product, scan the QR code. “

8000 A Zyklop Speed Ratchet with 1/4" drive

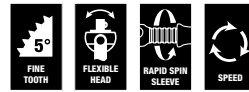

Application: 1/4" square sockets and 1/4" adaptors with square drive, equipped with ball lock

Design: Flywheel design and easy-to-grip free-turning sleeve for faster work, swivel ratchet head, defined lock positions at 0° and 90° to the left and right as well as at 15° before 90° inwards, at 0° it can be used like a conventional screwdriver, pushbutton release, left/right switchover, fine-tooth design, small return angle of 5°

Handle: Multi-component Kraftform handle ensures minimum fatigue

Icon	Part Number	Drive	Length (mm)
⬤	05003500001	1/4"	152,0

8000 A SB Zyklop Speed Ratchet with 1/4" drive

Icon	Part Number	Description	Barcode
⬤	05073260001	1 x 1/4"x152,0	4013288 128034





The Zyklop Metal Ratchets Push, 1/4"

With push-through square

8100 SA 7 Zyklop Metal Ratchet Set with push-through square, 1/4" drive, metric

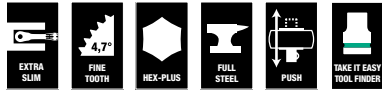

28-piece set; in a surface-preserving, compact and extremely robust textile box; low volume and weight for simplified mobility

1 Zyklop Metal Ratchet with push-through square and 1/4" drive, 9 Zyklop sockets, 1 Zyklop extension (long) with free-turning sleeve, 1 wobble extension, 1 adaptor with quick-release chuck, 15 bits

05004017001	
8003 A	1 x 1/4"x141,0
8790 HMA	1 x 5,0x23,0; 1 x 5,5x23,0; 1 x 6,0x23,0; 1 x 7,0x23,0; 1 x 8,0x23,0; 1 x 10,0x23,0; 1 x 11,0x23,0; 1 x 12,0x23,0; 1 x 13,0x23,0
8794 LA	1 x 1/4"x150,0
8794 A	1 x 1/4"x56,0
8784 A1	1 x 1/4"x1/4"x37,0
851/1 Z PH	1 x PH 1x25; 1 x PH 2x25; 1 x PH 3x25
855/1 Z PZ	1 x PZ 1x25; 1 x PZ 2x25
867/1 Z TORX®	1 x TX 10x25; 1 x TX 15x25; 1 x TX 20x25; 1 x TX 25x25; 1 x TX 27x25; 1 x TX 30x25
840/1 Z Hex-Plus	1 x 3,0x25; 1 x 4,0x25; 1 x 5,0x25; 1 x 6,0x25

8100 SA 10 Zyklop Metal Ratchet Set with push-through square, 1/4" drive, imperial



28-piece set; in a surface-preserving, compact and extremely robust textile box; low volume and weight for simplified mobility

1 Zyklop Metal Ratchet with push-through square and 1/4" drive, 9 Zyklop sockets, 1 Zyklop extension (long) with free-turning sleeve, 1 wobble extension, 1 adaptor with quick-release chuck, 15 bits

05004020001	
8003 A	1 x 1/4"x141,0
8790 HMA	1 x 3/16"x23,0; 1 x 7/32"x23,0; 1 x 1/4"x23,0; 1 x 9/32"x23,0; 1 x 5/16"x23,0; 1 x 11/32"x23,0; 1 x 3/8"x23,0; 1 x 7/16"x23,0; 1 x 1/2"x23,0
8794 LA	1 x 1/4"x150,0
8794 A	1 x 1/4"x56,0
8784 A1	1 x 1/4"x1/4"x37,0
851/1 Z PH	1 x PH 1x25; 1 x PH 2x25; 1 x PH 3x25
855/1 Z PZ	1 x PZ 1x25; 1 x PZ 2x25
867/1 Z TORX®	1 x TX 10x25; 1 x TX 15x25; 1 x TX 20x25; 1 x TX 25x25; 1 x TX 27x25; 1 x TX 30x25
840/1 Z Hex-Plus	1 x 5/32"x25; 1 x 3/16"x25; 1 x 7/32"x25; 1 x 1/4"x25

8003 A Zyklop Metal Ratchet with push-through square and 1/4" drive

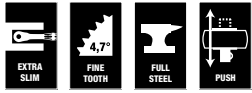

Application: 1/4" square sockets as well as for 1/4" adaptors with square drive, with ball locking device

Design: Forged, full metal ratchet (chrome-molybdenum) that is extremely robust with a long service life; slim design to enable work in very confined spaces; the dual-ratchet-teeth design means that a 76 fine-toothing division can be achieved from the 38 robust teeth with a return angle of only 4.7°; simple direction change with the undetachable push-through square and very secure socket lock mechanism

	mm	mm	mm	
05004003001	1/4"	141,0	21	22



” To learn more about this product, scan the QR code. “

Tip

The Zyklop Metal Ratchets Push



Forged, full metal ratchet (chrome-molybdenum) that is extremely robust with a long service life; slim design to enable work in very confined spaces.

Textile boxes



The textile boxes offer dramatically improved portability, and are space-saving to boot!

This means you can now carry the same collection of tools, in a much more compact and comfortable package. The hassle of running back and forth for the right tools has now become a thing of the past. And the much lower weight of a set makes carrying more convenient than ever before. The textile box including the tool will even survive a fall undamaged. And: it leaves absolutely no signs of scratches on sensitive surfaces.



“Take it easy”



“Take it easy” tool finder system – with profile and size colour-coding for quick and easy tool selection. Colour-coded system for hexagon drive screws (L-Keys, Zyklop bit sockets), external hex drive screws and nuts (Joker wrenches, Zyklop sockets and Zyklop bit sockets with holding function), and TORX® drive screws (L-Keys, Zyklop bit sockets).

The Zyklop Metal Ratchets Switch, 1/4"

With switch lever

8100 SA 8 Zyklop Metal Ratchet Set with switch lever, 1/4" drive, metric

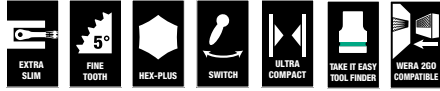

28-piece set; in a surface-preserving, compact and extremely robust textile box; low volume and weight for simplified mobility

1 Zyklop Metal Ratchet with switch lever and 1/4" drive, 9 Zyklop sockets, 1 Zyklop extension (long) with free-turning sleeve, 1 wobble extension, 1 adaptor with quick-release chuck, 15 bits

05004018001	
○	8004 A 1 x 1/4"x141,0
●	8790 HMA 1 x 5,0x23,0; 1 x 5,5x23,0; 1 x 6,0x23,0; 1 x 7,0x23,0; 1 x 8,0x23,0; 1 x 10,0x23,0; 1 x 11,0x23,0; 1 x 12,0x23,0; 1 x 13,0x23,0
⊕	8794 LA 1 x 1/4"x150,0
⊖	8794 A 1 x 1/4"x56,0
⊗	8784 A1 1 x 1/4"x1/4"x37,0
+	851/1 Z PH 1 x PH 1x25; 1 x PH 2x25; 1 x PH 3x25
+	855/1 Z PZ 1 x PZ 1x25; 1 x PZ 2x25
⊕	867/1 Z TORX® 1 x TX 10x25; 1 x TX 15x25; 1 x TX 20x25; 1 x TX 25x25; 1 x TX 27x25; 1 x TX 30x25
○	840/1 Z Hex-Plus 1 x 3,0x25; 1 x 4,0x25; 1 x 5,0x25; 1 x 6,0x25

8100 SA 11 Zyklop Metal Ratchet Set with switch lever, 1/4" drive, imperial



28-piece set; in a surface-preserving, compact and extremely robust textile box; low volume and weight for simplified mobility

1 Zyklop Metal Ratchet with switch lever and 1/4" drive, 9 Zyklop sockets, 1 Zyklop extension (long) with free-turning sleeve, 1 wobble extension, 1 adaptor with quick-release chuck, 15 bits

05004021001	
○	8004 A 1 x 1/4"x141,0
●	8790 HMA 1 x 3/16"x23,0; 1 x 7/32"x23,0; 1 x 1/4"x23,0; 1 x 9/32"x23,0; 1 x 5/16"x23,0; 1 x 11/32"x23,0; 1 x 3/8"x23,0; 1 x 7/16"x23,0; 1 x 1/2"x23,0
⊕	8794 LA 1 x 1/4"x150,0
⊖	8794 A 1 x 1/4"x56,0
⊗	8784 A1 1 x 1/4"x1/4"x37,0
+	851/1 Z PH 1 x PH 1x25; 1 x PH 2x25; 1 x PH 3x25
+	855/1 Z PZ 1 x PZ 1x25; 1 x PZ 2x25
⊕	867/1 Z TORX® 1 x TX 10x25; 1 x TX 15x25; 1 x TX 20x25; 1 x TX 25x25; 1 x TX 27x25; 1 x TX 30x25
○	840/1 Z Hex-Plus 1 x 5/32"x25; 1 x 3/16"x25; 1 x 7/32"x25; 1 x 1/4"x25

8100 SA 12 HF Zyklop Metal Ratchet Set with switch lever, 1/4" drive, metric



13-piece set; in a surface-preserving, compact and extremely robust textile box; low volume and weight for simplified mobility

1 Zyklop Metal Ratchet with switch lever and 1/4" drive, 9 Zyklop sockets with 1/4" drive with fastener holding function, 1 Zyklop extension (long) with free-turning sleeve, 1 wobble extension, 1 tool for the simple removal of nuts from sockets with holding function.

05003756001		
	8004 A	1 x 1/4"x141,0
	8794 LA	1 x 1/4"x150,0
	8794 A	1 x 1/4"x56,0
	8790 HMA HF	1 x 5,0x23,0; 1 x 5,5x23,0; 1 x 6,0x23,0; 1 x 7,0x23,0; 1 x 8,0x23,0; 1 x 10,0x23,0; 1 x 11,0x23,0; 1 x 12,0x23,0; 1 x 13,0x23,0
	Nut Extractor	1 x 14,0x43,0

8004 A Zyklop Metal Ratchet with switch lever and 1/4" drive



Application: 1/4" square sockets as well as for 1/4" adaptors with square drive, with ball locking device

Design: Forged, full metal ratchet (chrome-molybdenum) that is extremely robust with a long service life; slim design to enable work in very confined spaces; fine-tooth mechanism with 72 teeth for a return angle of only 5°; switch lever for convenient change of direction; secure socket locking function

	mm	mm	mm	
05004004001	1/4"	141,0	19	22

Tip

The Zyklop Metal Ratchets Switch



Extremely slim. Long leverage. Very robust without any torque limitation. Forged, full metal ratchet out of chrome molybdenum.

Textile boxes



The textile boxes offer dramatically improved portability, and are space-saving to boot!

This means you can now carry the same collection of tools, in a much more compact and comfortable package. The hassle of running back and forth for the right tools has now become a thing of the past. And the much lower weight of a set makes carrying more convenient than ever before. The textile box including the tool will even survive a fall undamaged. And: it leaves absolutely no signs of scratches on sensitive surfaces.



TAKE IT EASY
TOOL FINDER

"Take it easy"



"Take it easy" tool finder system – with profile and size colour-coding for quick and easy tool selection. Colour-coded system for hexagon drive screws (L-Keys, Zyklop bit sockets), external hex drive screws and nuts (Joker wrenches, Zyklop sockets and Zyklop bit sockets with holding function), and TORX® drive screws (L-Keys, Zyklop bit sockets).

Zyklop accessories, 1/4"

With amazing product benefits

8790 HMA Zyklop 1/4" socket



Application: Hexagon headed bolts, screws and nuts

Design: Manual and (non-impact) machine applications, ball intercept ring, knurls at base for precision handling in manual operations, chrome vanadium, brushed chrome-plated finish. Take it easy toolfinder: Colour coding and large stamp to enable the desired socket to be easily located.

8790 HMA HF Zyklop socket with 1/4" drive with holding function



Application: Hexagon headed bolts, screws and nuts

Design: Manual and (non-impact) machine applications, ball intercept ring, knurls at base for precision handling in manual operations, with holding function, chrome vanadium, brushed chrome-plated finish. Take it easy toolfinder: Colour coding and large stamp to enable the desired socket to be easily located.

	mm	mm	mm	mm	mm	mm
05003501001	4,0		23,0	6,9	13,0	10,0
05003502001	4,5		23,0	7,5	13,0	10,0
05003503001	5,0		23,0	8,2	13,0	10,0
05003504001	5,5		23,0	8,8	13,0	10,0
05003505001	6,0		23,0	9,4	13,0	10,0
05003506001	7,0		23,0	11,0	13,0	10,0
05003507001	8,0		23,0	12,0	13,0	10,0
05003508001	9,0		23,0	13,0	14,0	10,0
05003509001	10,0		23,0	14,5	14,5	-
05003510001	11,0		23,0	16,0	15,0	13,0
05003511001	12,0		23,0	17,0	16,0	13,0
05003512001	13,0		23,0	18,0	17,0	13,0
05003513001	14,0		23,0	20,0	18,0	13,0
05003514001		3/16"	23,0	7,5	13,0	10,0
05003515001		7/32"	23,0	8,8	13,0	10,0
05003516001		1/4"	23,0	11,0	13,0	10,0
05003517001		9/32"	23,0	11,0	13,0	10,0
05003518001		5/16"	23,0	12,0	13,0	10,0
05003519001		11/32"	23,0	13,0	14,0	10,0
05003520001		3/8"	23,0	14,5	14,5	-
05003521001		7/16"	23,0	16,0	15,0	13,0
05003522001		1/2"	23,0	18,0	17,0	13,0
05003523001		9/16"	23,0	20,0	18,0	13,0

	mm	mm	mm	mm	mm
05003717001	4,0	23,0	7,0	11,0	6,5
05003718001	4,5	23,0	7,8	11,0	6,5
05003719001	5,0	23,0	8,9	11,0	6,5
05003720001	5,5	23,0	9,2	11,0	6,5
05003721001	6,0	23,0	10,5	11,0	6,5
05003722001	7,0	23,0	11,9	11,0	6,5
05003723001	8,0	23,0	12,9	11,0	6,5
05003724001	9,0	23,0	14,1	12,0	6,5
05003725001	10,0	23,0	15,6	12,5	10,0
05003726001	11,0	23,0	17,4	13,0	10,0
05003727001	12,0	23,0	18,4	14,0	10,0
05003728001	13,0	23,0	19,5	15,0	10,0
05003729001	14,0	23,0	20,8	16,0	10,0

**Belt 1 A Zyklop socket set with holding function,
1/4" drive**



10-piece; robust textile socket belt, including snap hook to enable secure fastening to a belt loop or pocket. Non-woven reverse side and hook and loop strips for simple attachment e.g. to a wall, shelf, tool trolley and to the Wera 2go tool transport system. Fast and easy Twist to Unlock mechanism for secure storage and simple removal of the sockets.

9 Zyklop sockets with 1/4" drive with faster holding function. Take it easy tool finder: Colour coding to enable the desired bit socket to be easily selected. 1 tool for the simple removal of nuts from 1/4" sockets with holding function.

05003880001	
● 8790 HMA HF	1 x 4,0x23,0; 1 x 4,5x23,0; 1 x 5,0x23,0; 1 x 5,5x23,0; 1 x 6,0x23,0; 1 x 7,0x23,0; 1 x 8,0x23,0; 1 x 10,0x23,0; 1 x 13,0x23,0
Nut Extractor	1 x 14,0x43,0
Belt A 0/9	1 x 39,0x238,0
Hook and Loop Fastener Strip 30	1 x 30,0x200,0



Tip

How to avoid the need for two socket sets – one for manual and one for machine operations



The manual and machine sockets can be used both for hand and power tools use (non-impact). Users need just one socket set for all applications.

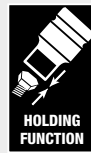

Sockets with retaining function for hexagon headed bolts, screws and nuts



The clamping of the screw is achieved by two flexible locking balls and a robust, permanently elastic, heat-shrunk tubing. The tubing is effectively protected against mechanical wear and tear by a steel ring. The holding function is especially helpful in confined, hard-to-reach spaces, where there is no room for a second hand to secure the screw.



Textile belt

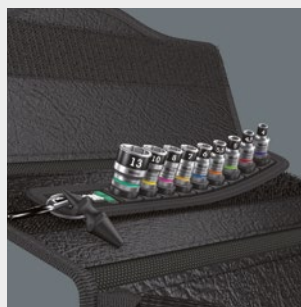

The textile belt can be attached by means of the nonwoven reverse side and the hook and loop strips e.g. to a wall, shelf, tool trolley and to the Wera 2go tool transport system.



Tip

Nut Extractor



Tool made out of synthetic plastic material (TPE) for the simple removal of nuts from sockets with holding function.

	mm	mm
05050005001	14,0	43,0

Nut extractor tool

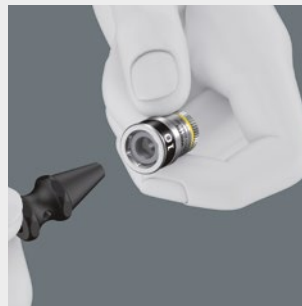

This tool enables hexagon nuts to be easily removed from sockets with holding function.

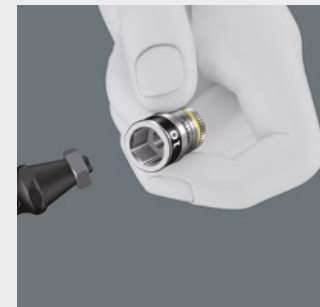
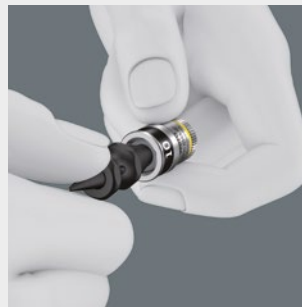

Belt A 4 Zyklop socket set, 1/4" drive



9-piece; robust textile socket belt, including snap hook to enable secure fastening to a belt loop or pocket. Non-woven reverse side and hook and loop strips for simple attachment e.g. to a wall, shelf, tool trolley and to the Wera 2go tool transport system. Smooth turning Fast and easy Twist to Unlock mechanism for secure storage and simple removal of the sockets.

9 Zyklop sockets with 1/4" drive. Take it easy tool finder: Colour coding to enable the desired socket to be easily selected.

05003883001	
	8790 HMA 1 x 5,0x23,0; 1 x 5,5x23,0; 1 x 6,0x23,0; 1 x 7,0x23,0; 1 x 8,0x23,0; 1 x 10,0x23,0; 1 x 11,0x23,0; 1 x 12,0x23,0; 1 x 13,0x23,0
	Belt A 0/9 1 x 39,0x238,0
	Hook and Loop Fastener Strip 30 1 x 30,0x200,0

Comes with convenient snap hook

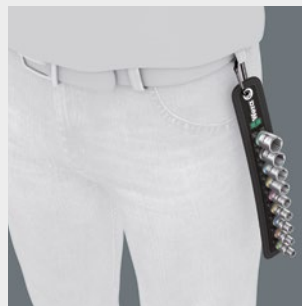

The robust textile belt can be secured to a belt loop or pocket by means of the snap hook.



Secure hold and easy removal



The all new smooth turning mechanism guarantees both secure and rattle-free storage, yet allows easy removal of the tool.

Zyklop accessories, 1/4"



With amazing product benefits

Belt A Imperial 1 Zyklop In-Hex-Plus bit socket set with holding function, 1/4" drive



9-piece; robust textile socket belt, including snap hook to enable secure fastening to a belt loop or pocket. Non-woven reverse side and hook and loop strips for simple attachment e.g. to a wall, shelf, tool trolley and to the Wera 2go tool transport system. Fast and easy Twist to Unlock mechanism for secure storage and simple removal of the sockets.

9 bit sockets for hexagon socket screws with 1/4" drive with holding function (sizes: 5/64", 3/32" and 7/64" without holding function) and Hex-Plus high torque geometry. Take it easy tool finder: Colour coding to enable the desired bit socket to be easily selected.







	
05003884001	
	8740 A 1 x 5/64"x28,0; 1 x 3/32"x28,0; 1 x 7/64"x28,0
	8740 A HF 1 x 1/8"x28,0; 1 x 9/64"x28,0; 1 x 5/32"x28,0; 1 x 3/16"x28,0; 1 x 7/32"x28,0; 1 x 1/4"x28,0
	Belt A 0/8 1 x 39,0x220,0
	Hook and Loop Fastener Strip 30 1 x 30,0x200,0

8767 A HF TORX® Zyklop bit socket with holding function, 1/4" drive



Application: TORX® socket screws

Design: Manual and (non-impact) machine applications, ball intercept ring, knurls at base for precision handling in manual operations, bit sockets with all the advantages of the Wera bit technology, brushed chrome-plated finish, holding function for TORX® screws made according to Acument Intellectual Properties specifications. Take it easy tool finder: Colour coding to enable the desired bit socket to be easily located

		 mm	 mm	 mm	 mm
05003360001	TX 8	28,0	12,0	12,5	11,0
05003361001	TX 9	28,0	12,0	12,5	11,0
05003362001	TX 10	28,0	12,0	12,5	11,0
05003363001	TX 15	28,0	12,0	12,5	11,0
05003364001	TX 20	28,0	12,0	12,5	11,0
05003365001	TX 25	28,0	12,0	12,5	11,0
05003366001	TX 25	100,0	12,0	12,5	83,0
05003367001	TX 27	28,0	12,0	12,5	11,0
05003368001	TX 27	100,0	12,0	12,5	83,0
05003369001	TX 30	28,0	12,0	12,5	11,0
05003370001	TX 30	100,0	12,0	12,5	83,0
05003371001	TX 40	28,0	12,0	12,5	11,0
05003372001	TX 40	100,0	12,0	12,5	83,0

Belt A 3 TORX® HF Zyklop bit-socket set with holding function, 1/4" drive



9-piece; robust textile socket belt, including snap hook to enable secure fastening to a belt loop or pocket. Non-woven reverse side and hook and loop strips for simple attachment e.g. to a wall, shelf, tool trolley and to the Wera 2go tool transport system. Fast and easy Twist to Unlock mechanism for secure storage and simple removal of the tool sockets.

9 Zyklop bit-sockets for TORX® screws, with 1/4" drive, with holding function. Take it easy tool finder: Colour coding to enable the desired bit-socket to be easily selected.

05003882001	
	8767 A HF 1 x TX 8x28,0; 1 x TX 9x28,0; 1 x TX 10x28,0; 1 x TX 15x28,0; 1 x TX 20x28,0; 1 x TX 25x28,0; 1 x TX 27x28,0; 1 x TX 30x28,0; 1 x TX 40x28,0
	Belt A 0/9 1 x 39,0x238,0
	Hook and Loop Fastener Strip 30 1 x 30,0x200,0

8767 A TORX® HF 1 Zyklop bit socket set with holding function, 1/4" drive



4-piece set

Pouch with 100 mm bit sockets

4 Zyklop bit sockets for TORX® screws, with 1/4" drive, with holding function. Take it easy tool finder: Colour coding to enable the desired bit socket to be easily selected.

05003375001	
	8767 A HF 1 x TX 25x100,0; 1 x TX 27x100,0; 1 x TX 30x100,0; 1 x TX 40x100,0
	Hook and Loop Fastener Strip 70 1 x 50,0x70,0

Tip



Bit sockets with holding function for TORX® screws



The HF tools developed by Wera are ideal because they feature an optimised geometry of the original TORX® profile. The wedging forces resulting from the surface pressure between the drive tip and the screw profile mean that TORX® screws made according to Acument Intellectual Properties specifications are securely held on the tool!

Extremely short



The bit sockets from Wera are characterized by a particularly short design. Ideal for working in tight spaces.

Wera bit technology



Due to their high-precision profile design and excellent concentricity properties, Wera bit sockets offer safe work and a long product life.

Zyklop accessories, 1/4"

With amazing product benefits

8740 A HF Zyklop bit socket bit socket with holding function, 1/4" drive



Application: Hexagon socket screws

Design: Manual and (non-impact) machine applications, ball intercept ring, knurls at base for precision handling in manual operations, bit sockets with all the advantages of the Wera bit technology, brushed chrome-plated finish, holding function for hexagon socket screws. Take it easy tool finder: Colour coding to enable the desired bit socket to be easily located

		mm	mm	mm	mm	mm	mm
05003332001		3,0		28,0	12,0	12,5	11,0
05003333001		4,0		28,0	12,0	12,5	11,0
05003334001		4,0		100,0	12,0	12,5	83,0
05003335001		5,0		28,0	12,0	12,5	11,0
05003336001		5,0		100,0	12,0	12,5	83,0
05003337001		6,0		28,0	12,0	12,5	11,0
05003338001		6,0		100,0	12,0	12,5	83,0
05003341001		7,0		28,0	12,0	12,5	11,0
05003342001		7,0		100,0	12,0	12,5	83,0
05003339001		8,0		28,0	12,0	12,5	11,0
05003340001		8,0		100,0	12,0	12,5	83,0
05003383001			1/8"	28,0	12,0	12,5	11,0
05003384001			9/64"	28,0	12,0	12,5	11,0
05003385001			5/32"	28,0	12,0	12,5	11,0
05003386001			3/16"	28,0	12,0	12,5	11,0
05003387001			7/32"	28,0	12,0	12,5	11,0
05003388001			1/4"	28,0	12,0	12,5	11,0
05003389001			5/16"	28,0	12,0	12,5	11,0

8740 A Zyklop bit socket, with 1/4" drive



Application: Hexagon socket screws

Design: Manual and (non-impact) machine applications, ball intercept ring, knurls at base for precision handling in manual operations, bit sockets with all the advantages of the Wera bit technology, brushed chrome-plated finish. Take it easy tool finder: Colour coding to enable the desired bit socket to be easily located

	mm	mm	mm	mm	mm	mm
05003330001	2,0		28,0	12,0	12,5	11,0
05003331001	2,5		28,0	12,0	12,5	11,0
05003380001		5/64"	28,0	12,0	12,5	11,0
05003381001		3/32"	28,0	12,0	12,5	11,0
05003382001		7/64"	28,0	12,0	12,5	11,0

Belt A 2 Zyklop In-Hex-Plus bit-socket set with holding function, 1/4" drive



8-piece; robust textile socket belt, including snap hook to enable secure fastening to a belt loop or pocket. Non-woven reverse side and hook and loop strips for simple attachment e.g. to a wall, shelf, tool trolley and to the Wera 2go tool transport system. Fast and easy Twist to Unlock mechanism for secure storage and simple removal of the sockets.

8 bit-sockets for hexagon socket screws with 1/4" drive with holding function and Hex-Plus high torque geometry. Take it easy tool finder: Colour coding to enable the desired bit-socket to be easily selected.

05003881001			
	8740 A	1 x 2,0x28,0; 1 x 2,5x28,0	
	8740 A HF	1 x 3,0x28,0; 1 x 4,0x28,0; 1 x 5,0x28,0; 1 x 6,0x28,0; 1 x 7,0x28,0; 1 x 8,0x28,0	
	Belt A 0/8	1 x 39,0x220,0	
	Hook and Loop Fastener Strip 30	1 x 30,0x200,0	

8740 A HF 1 Zyklop bit socket set with holding function, 1/4" drive



5-piece set

Pouch with 100 mm bit sockets

5 Zyklop bit sockets for hexagon socket screws, with 1/4" drive, with holding function, Take it easy tool finder: Colour coding to enable the desired bit socket to be easily located.

05003345001	
○	8740 A HF 1 x 4,0x100,0; 1 x 5,0x100,0; 1 x 6,0x100,0; 1 x 7,0x100,0; 1 x 8,0x100,0
	Hook and Loop Fastener Strip 70 1 x 50,0x70,0

Socket rail A (textile belt), 8 location, unloaded



1 robust textile belt, unloaded, for up to 8 sockets and/or bit sockets with 1/4" drive. Comes with a snap hook to enable secure fastening to a belt loop or pocket. Nonwoven reverse side and hook and loop strips for simple attachment e.g. to a wall, shelf, tool trolley and to the Wera 2go tool transport system. Fast and easy Twist to Unlock mechanism for secure storage and simple removal of the sockets.

05003890001	
	Belt A 0/8 1 x 39,0x220,0
	Hook and Loop Fastener Strip 30 1 x 30,0x200,0

Tip



Bit sockets with retaining function for hexagon socket screws



The clamping of the screw is achieved by a flexible locking ball. The holding function is especially helpful in confined, hard-to-reach spaces, where there is no room for a second hand to secure the screw.

Comes with convenient snap hook

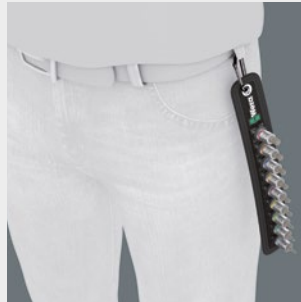

The robust textile belt can be secured to a belt loop or pocket by means of the snap hook.



Textile belt



The textile belt can be attached by means of the nonwoven reverse side and the hook and loop strips e.g. to a wall, shelf, tool trolley and to the Wera 2go tool transport system.

Zyklop accessories, 1/4"

With amazing product benefits

Socket rail A (textile belt), 9 location, unloaded



1 robust textile belt, unloaded, for up to 9 sockets and/or bit sockets, with 1/4" drive. Comes with a snap hook to enable secure fastening to a belt loop or pocket. Non-woven reverse side and hook and loop strips for simple attachment e.g. to a wall, shelf, tool trolley and to the Wera 2go tool transport system. Fast and easy Twist to Unlock mechanism for secure storage and simple removal of the sockets.

05003891001	
Belt A 0/9	1 x 39,0x238,0
Hook and Loop Fastener Strip 30	1 x 30,0x200,0

8751 A Phillips Zyklop bit socket with 1/4" drive



Application: Phillips screws

Design: Manual and (non-impact) machine applications, ball intercept ring, knurls at base for precision handling in manual operations, bit sockets with all the advantages of the Wera bit technology, brushed chrome-plated finish. Output colour coding (red = Phillips) and large stamp to enable the desired bit socket to be easily located.

		mm	mm	mm	mm
05003350001	PH 1	28,0	12,0	11,0	12,5
05003351001	PH 2	28,0	12,0	11,0	12,5
05003352001	PH 3	28,0	12,0	11,0	12,5

8755 A Pozidriv Zyklop bit socket with 1/4" drive



Application: Suitable for Pozidriv screws

Design: Manual and (non-impact) machine applications, ball intercept ring, knurls at base for precision handling in manual operations, bit sockets with all the advantages of the Wera bit technology, brushed chrome-plated finish. Output colour coding (black = Pozidriv) and large stamp to enable the desired bit socket to be easily located.

		mm	mm	mm	mm
05003353001	PZ 1	28,0	12,0	11,0	12,5
05003354001	PZ 2	28,0	12,0	11,0	12,5
05003355001	PZ 3	28,0	12,0	11,0	12,5

8700 A FL Slotted screws Zyklop bit socket with 1/4" drive



Application: Slotted screws

Design: Manual and (non-impact) machine applications, ball intercept ring, knurls at base for precision handling in manual operations, bit sockets with all the advantages of the Wera bit technology, brushed chrome-plated finish. Output colour coding (yellow = slotted) and large stamp to enable the desired bit socket to be easily located.

	mm	mm	mm	mm	mm	mm
05003320001	0,8	5,5	28,0	12,0	11,0	11,0
05003321001	1,0	5,5	28,0	12,0	11,0	11,0
05003322001	1,2	6,5	28,0	12,0	11,0	11,0

Tip

Comes with convenient snap hook



The robust textile belt can be secured to a belt loop or pocket by means of the snap hook.



Practical nonwoven strips



The textile belt can be attached by means of the nonwoven reverse side and the hook and loop strips e.g. to a wall, shelf, tool trolley and to the Wera 2go tool transport system.



"Take it easy"

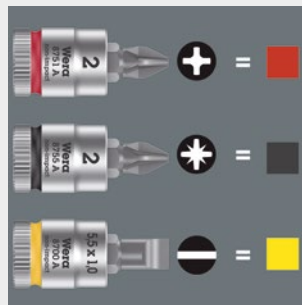

"Take it easy" tool finder system – with profile and size colour-coding for quick and easy tool selection. Colour-coded system for hexagon drive screws (L-Keys, Zyklop bit sockets), external hex drive screws and nuts (Joker wrenches, Zyklop sockets and Zyklop bit sockets with holding function), and TORX® drive screws (L-Keys, Zyklop bit sockets).

Zyklop accessories, 1/4"



With amazing product benefits

8796 SA Zyklop "flexible-lock" extension with free-turning sleeve, short, 1/4"



Application: 1/4" square drive sockets with ball lock

Design: Flexible-lock-system either for permanent interlocking or fast change of accessories, free-turning sleeve for rapid tightening or loosening of screws and nuts, chrome vanadium, brushed chrome-plated finish



		mm
05003530001	1/4"	75,0

8796 LA Zyklop "flexible-lock" extension with free-turning sleeve, long, 1/4"



Application: 1/4" square drive sockets with ball lock

Design: Flexible-lock-system either for permanent interlocking or fast change of accessories, free-turning sleeve for rapid tightening or loosening of screws and nuts, chrome vanadium, brushed chrome-plated finish



		mm
05003531001	1/4"	150,0

8789 A Zyklop sliding T-handle, 1/4"



Application: 1/4" square drive sockets with ball lock

Design: Sliding drive, chrome vanadium, brushed chrome-plated finish



		mm
05003524001	1/4"	110,0

8794 LA Zyklop extension with free-turning sleeve, long, 1/4"



Application: 1/4" square drive sockets with ball lock

Design: Easy-to-grip free-turning sleeve for rapid tightening or loosening of screws and nuts, chrome vanadium, brushed chrome-plated finish



		mm
05003526001	1/4"	150,0

**8794 SA Zyklop extension
with free-turning sleeve, short, 1/4"**



Application: 1/4" square drive sockets with ball lock

Design: Easy-to-grip free-turning sleeve for rapid tightening or loosening of screws and nuts, chrome vanadium, brushed chrome-plated finish

		mm
05003525001	1/4"	75,0

Tip



"Flexible-lock-system"

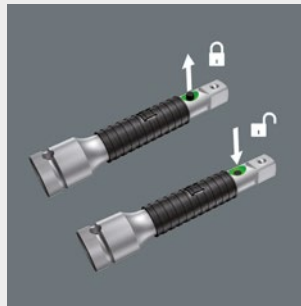

The extensions from the premium lines are also equipped with the unique "flexible-lock-system". By activating this system, attachments can be fixed to the extension permanently – preventing slipping and any unintentional loss of the attachment. When the system is deactivated, the sockets can be attached as usual and changed in a flash.



The free-turning sleeve



The free-turning sleeve effectively speeds up the tightening or loosening of screws and bolts.





8795 A Zyklop universal joint, 1/4"



Application: 1/4" square drive sockets with ball lock

Design: Chrome vanadium/chrome molybdenum, brushed chrome-plated finish



	 	mm
05003528001	1/4"	35,5

8794 A Zyklop wobble extension, 1/4"



Application: 1/4" square drive sockets with ball lock

Design: Swivels through 15°, chrome vanadium, brushed chrome-plated finish





	 	mm
05003527001	1/4"	56,0

8784 A1 Zyklop bit adaptor, 1/4"



Application: Suitable for 1/4" hex bits as per DIN ISO 1173-C 6,3 and E 6,3 and Wera series 1 and 4

Design: Quick-release chuck for fast bit changes, chromium vanadium

	 		mm
05003529001	1/4"	1/4"	37,0

Tip

How to work well in confined installation areas



The Zyklop wobble extensions pivot through 15° in all directions. This enables rapid and precise work in concealed or confined installation areas.





Zyklop Ratchets, 3/8"



Zyklop Speed

172



Zyklop Metal Push

176



Zyklop Metal Switch

178



Zyklop Accessories

180



The Zyklop Speed Ratchets, $\frac{3}{8}$ "

5 types of ratchet in 1 tool

8100 SB 6 Zyklop Speed Ratchet Set, $\frac{3}{8}$ " drive, metric

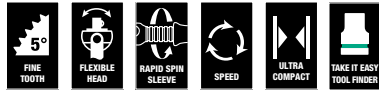

29-piece set; in a surface-preserving, compact and extremely robust textile box; low volume and weight for simplified mobility

1 Zyklop Speed Ratchet with $\frac{3}{8}$ " drive, 9 Zyklop sockets, 1 Zyklop extension (long) with free-turning sleeve, 1 wobble extension, 1 adaptor with quick-release chuck, 16 bits

05004046001		
⊙	8000 B	1 x 3/8"x199,0
⊙	8790 HMB	1 x 8,0x29,0; 1 x 10,0x29,0; 1 x 12,0x29,0; 1 x 13,0x29,0; 1 x 15,0x29,0; 1 x 16,0x30,0; 1 x 17,0x30,0; 1 x 18,0x30,0; 1 x 19,0x30,0
⊙	8794 LB	1 x 3/8"x200,0
⊙	8794 B	1 x 3/8"x76,0
⊙	8784 B1	1 x 1/4"x3/8"x44,0
+	851/4 TZ PH	1 x PH 1x50; 1 x PH 2x50; 1 x PH 3x50
+	855/4 TZ PZ	1 x PZ 1x50; 1 x PZ 2x50; 1 x PZ 3x50
⊗	867/4 Z TORX®	1 x TX 20x50; 1 x TX 25x50; 1 x TX 27x50; 1 x TX 30x50; 1 x TX 40x50
○	840/4 Z Hex-Plus	1 x 4,0x50; 1 x 5,0x50; 1 x 6,0x50; 1 x 8,0x50
●	800/4 Z	1 x 1,0x5,5x50

8100 SB 9 Zyklop Speed Ratchet Set, $\frac{3}{8}$ " drive, imperial

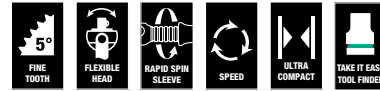

29-piece set; in a surface-preserving, compact and extremely robust textile box; low volume and weight for simplified mobility

1 Zyklop Speed Ratchet with $\frac{3}{8}$ " drive, 9 Zyklop sockets, 1 Zyklop extension (long) with free-turning sleeve, 1 wobble extension, 1 adaptor with quick-release chuck, 16 bits

05004049001		
⊙	8000 B	1 x 3/8"x199,0
⊙	8790 HMB	1 x 1/4"x29,0; 1 x 5/16"x29,0; 1 x 3/8"x29,0; 1 x 7/16"x29,0; 1 x 1/2"x29,0; 1 x 9/16"x29,0; 1 x 5/8"x30,0; 1 x 11/16"x30,0; 1 x 3/4"x30,0
⊙	8794 LB	1 x 3/8"x200,0
⊙	8794 B	1 x 3/8"x76,0
⊙	8784 B1	1 x 1/4"x3/8"x44,0
+	851/4 TZ PH	1 x PH 1x50; 1 x PH 2x50; 1 x PH 3x50
+	855/4 TZ PZ	1 x PZ 1x50; 1 x PZ 2x50; 1 x PZ 3x50
⊗	867/4 Z TORX®	1 x TX 20x50; 1 x TX 25x50; 1 x TX 27x50; 1 x TX 30x50; 1 x TX 40x50
○	840/4 Z Hex-Plus	1 x 3/16"x50; 1 x 7/32"x50; 1 x 1/4"x50; 1 x 5/16"x50
●	800/4 Z	1 x 1,0x5,5x50

8100 SB 2 Zyklop Speed Ratchet Set, 3/8" drive, metric

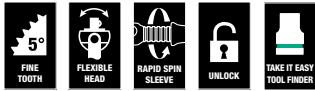

43-piece set in strong metal case

1 Zyklop ratchet with 3/8" drive, 18 Zyklop sockets (metric), 2 Zyklop "flexible-lock" extensions (short and long) with free-turning sleeve, 1 sliding T-handle, 1 wobble extension, 1 universal joint, 1 adaptor with quick-release chuck, 18 bits

05003594001		
⊙	8000 B	1 x 3/8"x199,0
⊙	8790 HMB	1 x 6,0x29,0; 1 x 7,0x29,0; 1 x 8,0x29,0; 1 x 9,0x29,0; 1 x 10,0x29,0; 1 x 11,0x29,0; 1 x 12,0x29,0; 1 x 13,0x29,0; 1 x 14,0x29,0; 1 x 15,0x29,0; 1 x 16,0x30,0; 1 x 17,0x30,0; 1 x 18,0x30,0; 1 x 19,0x30,0; 1 x 20,0x30,0; 1 x 21,0x30,0; 1 x 22,0x30,0; 1 x 24,0x32,0
⊙	8789 B	1 x 3/8"x165,0
⊙	8794 B	1 x 3/8"x76,0
⊙	8795 B	1 x 3/8"x50,0
⊙	8784 B1	1 x 1/4"x3/8"x44,0
⊙	8796 SB	1 x 3/8"x125,0
⊙	8796 LB	1 x 3/8"x200,0
⊙	840/1 Z Hex-Plus	1 x 3,0x25; 1 x 4,0x25; 1 x 5,0x25; 1 x 6,0x25; 1 x 8,0x25; 1 x 10,0x25
⊙	867/1 Z TORX® B0	1 x TX 10x25; 1 x TX 15x25; 1 x TX 20x25; 1 x TX 25x25; 1 x TX 27x25; 1 x TX 30x25; 1 x TX 40x25
⊙	800/1 Z	1 x 1,0x5,5x25
⊙	851/1 Z PH	1 x PH 2x25; 1 x PH 3x25
⊙	855/1 Z PZ	1 x PZ 2x25; 1 x PZ 3x25

Tip

Zyklop "6 in 1"



1. Fine-tooth ratchet
2. Flex-head ratchet
3. Angle ratchet
4. Quick-release ratchet
5. Power ratchet
6. Screwdriver

Textile boxes



The textile boxes offer dramatically improved portability, and are space-saving to boot!

This means you can now carry the same collection of tools, in a much more compact and comfortable package. The hassle of running back and forth for the right tools has now become a thing of the past. And the much lower weight of a set makes carrying more convenient than ever before. The textile box including the tool will even survive a fall undamaged. And: it leaves absolutely no signs of scratches on sensitive surfaces.



The Zyklop VDE ratchet and accessories



The Zyklop VDE ratchet with 3/8" drive and the accessories can be found on pages 124-129.

The Zyklop Speed Ratchets, $\frac{3}{8}$ "

5 types of ratchet in 1 tool

8100 SB 4 Zyklop Speed Ratchet Set, $\frac{3}{8}$ " drive, imperial

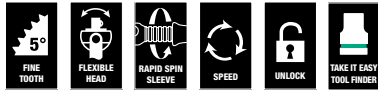

38-piece set in strong metal case

1 Zyklop ratchet with $\frac{3}{8}$ " drive, 12 Zyklop sockets (imperial), 2 Zyklop "flexible-lock" extensions (short and long) with free-turning sleeve, 1 sliding T-handle, 1 wobble extension, 1 universal joint, 1 adaptor with quick-release chuck, 19 bits

05003596001		
●	8000 B	1 x 3/8"x199,0
●	8790 HMB	1 x 1/4"x29,0; 1 x 5/16"x29,0; 1 x 11/32"x29,0; 1 x 3/8"x29,0; 1 x 7/16"x29,0; 1 x 1/2"x29,0; 1 x 9/16"x29,0; 1 x 5/8"x30,0; 1 x 11/16"x30,0; 1 x 3/4"x30,0; 1 x 13/16"x30,0; 1 x 7/8"x30,0
○	8789 B	1 x 3/8"x165,0
○	8794 B	1 x 3/8"x76,0
○	8795 B	1 x 3/8"x50,0
○	8784 B1	1 x 1/4"x3/8"x44,0
○	8796 SB	1 x 3/8"x125,0
○	8796 LB	1 x 3/8"x200,0
⊕	867/1 Z TORX® B0	1 x TX 10x25; 1 x TX 15x25; 1 x TX 20x25; 1 x TX 25x25; 1 x TX 27x25; 1 x TX 30x25; 1 x TX 40x25
⊖	800/1 Z	1 x 1,0x5,5x25
⊕	851/1 Z PH	1 x PH 2x25; 1 x PH 3x25
⊕	855/1 Z PZ	1 x PZ 2x25; 1 x PZ 3x25
○	840/1 Z Hex-Plus	1 x 5/64"x25; 1 x 3/32"x25; 1 x 1/8"x25; 1 x 9/64"x25; 1 x 5/32"x25; 1 x 3/16"x25; 1 x 7/32"x25

8000 B Zyklop Speed Ratchet with $\frac{3}{8}$ " drive

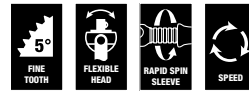

Application: $\frac{3}{8}$ " square drive sockets and $\frac{3}{8}$ " adaptors with square drive, equipped with ball lock

Design: Flywheel design and easy-to-grip free-turning sleeve for faster work, swivel ratchet head, defined lock positions at 0° and 90° to the left and right as well as at 15° before 90° inwards, at 0° it can be used like a conventional screwdriver, pushbutton release, left/right switchover, fine-tooth design, small return angle of 5°

Handle: Multi-component Kraffform handle ensures minimum fatigue

05003550001	$\frac{3}{8}$ "	199,0 mm

8000 B SB Zyklop Speed Ratchet with $\frac{3}{8}$ " drive

05073261001	1 x 3/8"x199,0	4013288 128041





Tip

How to notice missing tools more quickly



Perfectly conceived in every detail: the storage case for the ZykloSpeed ratchet sets! The two-tone foam insert section means that the tools can be quickly and reliably replaced, and that missing tools can be detected immediately. The tools and their position can be clearly seen in the lid where they have been laser-etched, ensuring

that they are legible even when the insert section is covered with grease, dirt or oil. Additionally, the foam section can be removed and placed in the drawer of a tool cabinet or trolley.



“Flexible-lock-system”

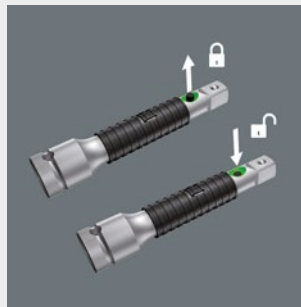

The extensions from the premium lines are also equipped with the unique “flexible-lock-system”. By activating this system, attachments can be fixed to the extension permanently – preventing slipping and any unintentional loss of the attachment. When the system is deactivated, the sockets can be attached as usual and changed in a flash.



The Zyklo VDE ratchet and accessories



The Zyklo VDE ratchet with 3/8" drive and the accessories can be found on pages 124-129.

The Zyklop Metal Ratchets Push, $\frac{3}{8}$ "

With push-through square

8100 SB 7 Zyklop Metal Ratchet Set with push-through square, $\frac{3}{8}$ " drive, metric

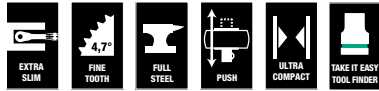

29-piece set; in a surface-preserving, compact and extremely robust textile box; low volume and weight for simplified mobility

1 Zyklop Metal Ratchet with $\frac{3}{8}$ " drive, 9 Zyklop sockets, 1 Zyklop extension (long) with free-turning sleeve, 1 wobble extension, 1 adaptor with quick-release chuck, 16 bits

05004047001	
8003 B	1 x 3/8"x222,0
8790 HMB	1 x 8,0x29,0; 1 x 10,0x29,0; 1 x 12,0x29,0; 1 x 13,0x29,0; 1 x 15,0x29,0; 1 x 16,0x30,0; 1 x 17,0x30,0; 1 x 18,0x30,0; 1 x 19,0x30,0
8794 LB	1 x 3/8"x200,0
8794 B	1 x 3/8"x76,0
8784 B1	1 x 1/4"x3/8"x44,0
851/1 Z PH	1 x PH 1x25; 1 x PH 2x25; 1 x PH 3x25
855/1 Z PZ	1 x PZ 1x25; 1 x PZ 2x25
867/1 Z TORX®	1 x TX 15x25; 1 x TX 20x25; 1 x TX 25x25; 1 x TX 27x25; 1 x TX 30x25; 1 x TX 40x25
840/1 Z Hex-Plus	1 x 3,0x25; 1 x 4,0x25; 1 x 5,0x25; 1 x 6,0x25; 1 x 8,0x25

8100 SB 10 Zyklop Metal Ratchet Set with push-through square, $\frac{3}{8}$ " drive, imperial

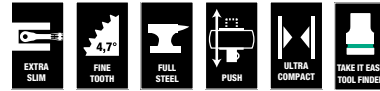

29-piece set; in a surface-preserving, compact and extremely robust textile box; low volume and weight for simplified mobility

1 Zyklop Metal Ratchet with $\frac{3}{8}$ " drive, 9 Zyklop sockets, 1 Zyklop extension (long) with free-turning sleeve, 1 wobble extension, 1 adaptor with quick-release chuck, 16 bits

05004050001	
8003 B	1 x 3/8"x222,0
8790 HMB	1 x 1/4"x29,0; 1 x 5/16"x29,0; 1 x 3/8"x29,0; 1 x 7/16"x29,0; 1 x 1/2"x29,0; 1 x 9/16"x29,0; 1 x 5/8"x30,0; 1 x 11/16"x30,0; 1 x 3/4"x30,0
8794 LB	1 x 3/8"x200,0
8794 B	1 x 3/8"x76,0
8784 B1	1 x 1/4"x3/8"x44,0
851/1 Z PH	1 x PH 1x25; 1 x PH 2x25; 1 x PH 3x25
855/1 Z PZ	1 x PZ 1x25; 1 x PZ 2x25
867/1 Z TORX®	1 x TX 15x25; 1 x TX 20x25; 1 x TX 25x25; 1 x TX 27x25; 1 x TX 30x25; 1 x TX 40x25
840/1 Z Hex-Plus	1 x 5/32"x25; 1 x 3/16"x25; 1 x 7/32"x25; 1 x 1/4"x25; 1 x 5/16"x25

8003 B Zyklop Metal Ratchet with push-through square and $\frac{3}{8}$ " drive

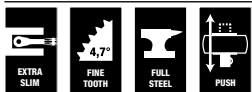

Application: $\frac{3}{8}$ " square sockets as well as for $\frac{3}{8}$ " adaptors with square drive, with ball locking device

Design: Forged, full metal ratchet (chrome-molybdenum) that is extremely robust with a long service life; slim design to enable work in very confined spaces; the dual-ratchet-teeth design means that a 76 fine-toothing division can be achieved from the 38 robust teeth with a return angle of only 4.7°; simple direction change with the undetachable push-through square and very secure socket lock mechanism

	mm	mm	mm	mm
05004033001	$\frac{3}{8}$ "	222,0	27	29

Tip

The Zyklop Metal Ratchets Push



Forged, full metal ratchet (chrome-molybdenum) that is extremely robust with a long service life; slim design to enable work in very confined spaces.

Textile boxes



The textile boxes offer dramatically improved portability, and are space-saving to boot!

This means you can now carry the same collection of tools, in a much more compact and comfortable package. The hassle of running back and forth for the right tools has now become a thing of the past. And the much lower weight of a set makes carrying more convenient than ever before. The textile box including the tool will even survive a fall undamaged. And: it leaves absolutely no signs of scratches on sensitive surfaces.



The Zyklop VDE ratchet and accessories



The Zyklop VDE ratchet with $\frac{3}{8}$ " drive and the accessories can be found on pages 124-129.

The Zyklop Metal Ratchets Switch, $\frac{3}{8}$ "

With switch lever

8100 SB 8 Zyklop Metal Ratchet Set with switch lever, $\frac{3}{8}$ " drive, metric



29-piece set; in a surface-preserving, compact and extremely robust textile box; low volume and weight for simplified mobility

1 Zyklop Metal Ratchet with $\frac{3}{8}$ " drive, 9 Zyklop sockets, 1 Zyklop extension (long) with free-turning sleeve, 1 wobble extension, 1 adaptor with quick-release chuck, 16 bits

05004048001		
○	8004 B	1 x 3/8"x222,0
●	8790 HMB	1 x 8,0x29,0; 1 x 10,0x29,0; 1 x 12,0x29,0; 1 x 13,0x29,0; 1 x 15,0x29,0; 1 x 16,0x30,0; 1 x 17,0x30,0; 1 x 18,0x30,0; 1 x 19,0x30,0
⊗	8794 LB	1 x 3/8"x200,0
⊗	8794 B	1 x 3/8"x76,0
⊗	8784 B1	1 x 1/4"x3/8"x44,0
+	851/1 Z PH	1 x PH 1x25; 1 x PH 2x25; 1 x PH 3x25
+	855/1 Z PZ	1 x PZ 1x25; 1 x PZ 2x25
⊗	867/1 Z TORX®	1 x TX 15x25; 1 x TX 20x25; 1 x TX 25x25; 1 x TX 27x25; 1 x TX 30x25; 1 x TX 40x25
○	840/1 Z Hex-Plus	1 x 3,0x25; 1 x 4,0x25; 1 x 5,0x25; 1 x 6,0x25; 1 x 8,0x25

8100 SB 11 Zyklop Metal Ratchet Set with switch lever, $\frac{3}{8}$ " drive, imperial

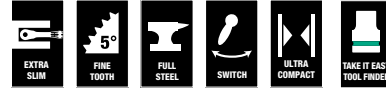

29-piece set; in a surface-preserving, compact and extremely robust textile box; low volume and weight for simplified mobility

1 Zyklop Metal Ratchet with $\frac{3}{8}$ " drive, 9 Zyklop sockets, 1 Zyklop extension (long) with free-turning sleeve, 1 wobble extension, 1 adaptor with quick-release chuck, 16 bits

05004051001		
○	8004 B	1 x 3/8"x222,0
●	8790 HMB	1 x 1/4"x29,0; 1 x 5/16"x29,0; 1 x 3/8"x29,0; 1 x 7/16"x29,0; 1 x 1/2"x29,0; 1 x 9/16"x29,0; 1 x 5/8"x30,0; 1 x 11/16"x30,0; 1 x 3/4"x30,0
⊗	8794 LB	1 x 3/8"x200,0
⊗	8794 B	1 x 3/8"x76,0
⊗	8784 B1	1 x 1/4"x3/8"x44,0
+	851/1 Z PH	1 x PH 1x25; 1 x PH 2x25; 1 x PH 3x25
+	855/1 Z PZ	1 x PZ 1x25; 1 x PZ 2x25
⊗	867/1 Z TORX®	1 x TX 15x25; 1 x TX 20x25; 1 x TX 25x25; 1 x TX 27x25; 1 x TX 30x25; 1 x TX 40x25
○	840/1 Z Hex-Plus	1 x 5/32"x25; 1 x 3/16"x25; 1 x 7/32"x25; 1 x 1/4"x25; 1 x 5/16"x25

8100 SB HF 1 Zyklop Metal Ratchet Set with switch lever, 3/8" drive, with holding function, metric



13-piece set; in a surface-preserving, compact and extremely robust textile box; low volume and weight for simplified mobility. Non-woven reverse side and hook and loop strips for simple attachment e.g. to a wall, shelf, tool trolley and to the Wera 2go tool transport system. Fast and easy Twist to Unlock mechanism for secure storage and simple removal of the sockets.

1 Zyklop Metal Ratchet with 3/8" drive, 9 Zyklop sockets with 3/8" drive with fastener holding function. Take it easy tool finder: Colour coding to enable the desired socket to be easily selected. 1 tool for the simple removal of nuts from sockets with holding function, 1 Zyklop extension (long) with free-turning sleeve, 1 wobble extension

05003785001		
	8004 B	1 x 3/8"x222,0
	8790 HMB HF	1 x 8,0x29,0; 1 x 10,0x29,0; 1 x 12,0x29,0; 1 x 13,0x29,0; 1 x 15,0x29,0; 1 x 16,0x29,0; 1 x 17,0x29,0; 1 x 18,0x29,0; 1 x 19,0x29,0
	8794 LB	1 x 3/8"x200,0
	8794 B	1 x 3/8"x76,0
	Nut Extractor	1 x 14,0x43,0

8004 B Zyklop Metal Ratchet with switch lever and 3/8" drive



Application: 3/8" square sockets as well as for 3/8" adaptors with square drive, with ball locking device

Design: Forged, full metal ratchet (chrome-molybdenum) that is extremely robust with a long service life; slim design to enable work in very confined spaces; fine-tooth mechanism with 72 teeth for a return angle of only 5°; switch lever for convenient change of direction; secure socket locking function

	mm	mm	mm
05004034001	3/8"	222,0	26 29

Tip

The Zyklop Metal Ratchets Switch



Extremely slim. Long leverage. Very robust without any torque limitation. Forged, full metal ratchet out of chrome molybdenum.



The Zyklop VDE ratchet and accessories



The Zyklop VDE ratchet with 3/8" drive and the accessories can be found on pages 124-129.



"Take it easy"



"Take it easy" tool finder system – with profile and size colour-coding for quick and easy tool selection. Colour-coded system for hexagon drive screws (L-Keys, Zyklop bit sockets), external hex drive screws and nuts (Joker wrenches, Zyklop sockets and Zyklop bit sockets with holding function), and TORX® drive screws (L-Keys, Zyklop bit sockets).

Zyklop Accessories, $\frac{3}{8}$ "

With amazing product benefits

8790 HMB Zyklop $\frac{3}{8}$ " socket



Application: Hexagon headed bolts, screws and nuts

Design: Manual and (non-impact) machine applications, ball intercept ring, knurls at base for precision handling in manual operations, chrome vanadium, brushed chrome-plated finish
Take it easy toolfinder: Colour coding to enable the desired socket to be easily located.

8790 HMB HF Zyklop socket with $\frac{3}{8}$ " drive with holding function



Application: Hexagon headed bolts, screws and nuts

Design: Manual and (non-impact) machine applications, ball intercept ring, knurls at base for precision handling in manual operations, with holding function, chrome vanadium, brushed chrome-plated finish. Take it easy tool finder: Colour coding and large stamp to enable the desired socket to be easily located.

	mm	mm	mm	mm	mm	mm
05003551001	6,0	29,0	10,5	18,0	12,0	
05003552001	7,0	29,0	11,0	18,0	12,0	
05003553001	8,0	29,0	12,2	18,0	12,0	
05003554001	9,0	29,0	13,5	18,0	12,0	
05003555001	10,0	29,0	14,5	18,0	12,0	
05003556001	11,0	29,0	16,0	18,0	12,0	
05003557001	12,0	29,0	17,0	18,0	12,0	
05003558001	13,0	29,0	18,5	20,0	12,0	
05003559001	14,0	29,0	19,5	22,0	12,0	
05003560001	15,0	29,0	21,0	24,0	12,0	
05003561001	16,0	30,0	22,0	24,0	12,0	
05003562001	17,0	30,0	23,5	24,0	12,0	
05003563001	18,0	30,0	24,5	24,0	18,0	
05003564001	19,0	30,0	26,0	24,0	18,0	
05003565001	20,0	30,0	28,0	25,0	18,0	
05003566001	21,0	30,0	28,0	25,0	18,0	
05003567001	22,0	30,0	32,0	25,0	18,0	
05003568001	24,0	32,0	32,0	25,0	20,0	
05003569001	$\frac{1}{4}$ "	29,0	11,0	18,0	12,0	
05003570001	$\frac{5}{16}$ "	29,0	12,2	18,0	12,0	
05003571001	$\frac{11}{32}$ "	29,0	13,5	18,0	12,0	
05003572001	$\frac{3}{8}$ "	29,0	14,5	18,0	12,0	
05003573001	$\frac{7}{16}$ "	29,0	16,0	18,0	12,0	
05003574001	$\frac{1}{2}$ "	29,0	18,5	20,0	12,0	
05003575001	$\frac{9}{16}$ "	29,0	19,5	22,0	12,0	
05003576001	$\frac{5}{8}$ "	30,0	22,0	24,0	12,0	
05003577001	$\frac{11}{16}$ "	30,0	23,0	24,0	18,0	
05003578001	$\frac{3}{4}$ "	30,0	26,0	24,0	18,0	
05003579001	$\frac{13}{16}$ "	30,0	28,0	25,0	18,0	
05003580001	$\frac{7}{8}$ "	30,0	32,0	25,0	18,0	

	mm	mm	mm	mm	mm
05003740001	6,0	29,0	10,5	17,5	6,5
05003741001	7,0	29,0	11,2	17,5	6,5
05003742001	8,0	29,0	12,2	17,5	6,5
05003743001	9,0	29,0	13,7	17,5	6,5
05003744001	10,0	29,0	15,0	17,5	8,0
05003745001	11,0	29,0	16,2	17,5	9,5
05003746001	12,0	29,0	17,0	17,5	9,5
05003747001	13,0	29,0	18,4	19,5	9,5
05003748001	14,0	29,0	19,5	21,5	12,5
05003749001	15,0	29,0	21,0	23,5	12,5
05003750001	16,0	29,0	22,2	23,5	12,5
05003751001	17,0	29,0	24,0	23,5	12,5
05003752001	18,0	29,0	24,5	23,5	12,5
05003753001	19,0	29,0	26,0	23,5	12,5

Belt B 1 Zyklop socket set with holding function, $\frac{3}{8}$ " drive



10-piece; robust textile socket belt, including snap hook to enable secure fastening to a belt loop or pocket. Non-woven reverse side and hook and loop strips for simple attachment e.g. to a wall, shelf, tool trolley and to the Wera 2go tool transport system. Fast and easy Twist to Unlock mechanism for secure storage and simple removal of the sockets.

9 Zyklop sockets with $\frac{3}{8}$ " drive with fastener holding function. Take it easy tool finder: Colour coding to enable the desired socket to be easily selected. 1 tool for the simple removal of nuts from sockets with holding function.

05003970001	
8790 HMB HF	1 x 8,0x29,0; 1 x 10,0x29,0; 1 x 12,0x29,0; 1 x 13,0x29,0; 1 x 15,0x29,0; 1 x 16,0x29,0; 1 x 17,0x29,0; 1 x 18,0x29,0; 1 x 19,0x29,0
Nut Extractor	1 x 14,0x43,0
Belt B 0/9	1 x 45,0x310,0
Hook and Loop Fastener Strip 30	1 x 30,0x200,0

Belt B 4 Zyklop socket set, $\frac{3}{8}$ " drive



9-piece; robust textile socket belt, including snap hook to enable secure fastening to a belt loop or pocket. Non-woven reverse side and hook and loop strips for simple attachment e.g. to a wall, shelf, tool trolley and to the Wera 2go tool transport system. Smooth turning Fast and easy Twist to Unlock mechanism for secure storage and simple removal of the sockets.

9 Zyklop sockets with $\frac{3}{8}$ " drive. Take it easy tool finder: Colour coding to enable the desired socket to be easily selected.

05003973001	
8790 HMB	1 x 8,0x29,0; 1 x 10,0x29,0; 1 x 12,0x29,0; 1 x 13,0x29,0; 1 x 15,0x29,0; 1 x 16,0x30,0; 1 x 17,0x30,0; 1 x 18,0x30,0; 1 x 19,0x30,0
Belt B 0/9	1 x 45,0x310,0
Hook and Loop Fastener Strip 30	1 x 30,0x200,0

Tip

How to avoid the need for two socket sets – one for manual and one for machine operations



The manual and machine sockets can be used both for hand and power tools use (non-impact). Users need just one socket set for all applications.



Textile belt



The textile belt can be attached by means of the nonwoven reverse side and the hook and loop strips e.g. to a wall, shelf, tool trolley and to the Wera 2go tool transport system.



"Take it easy"



"Take it easy" tool finder system – with profile and size colour-coding for quick and easy tool selection. Colour-coded system for hexagon drive screws (L-Keys, Zyklop bit sockets), external hex drive screws and nuts (Joker wrenches, Zyklop sockets and Zyklop bit sockets with holding function), and TORX® drive screws (L-Keys, Zyklop bit sockets).

Zyklop Accessories, $\frac{3}{8}$ "

With amazing product benefits

Nut Extractor



Tool made out of synthetic plastic material (TPE) for the simple removal of nuts from sockets with holding function.

	mm	mm
05050005001	14,0	43,0

8767 B HF TORX® Zyklop bit socket with holding function, $\frac{3}{8}$ " drive



Application: TORX® socket screws

Design: Manual and (non-impact) machine applications, ball intercept ring, knurls at base for precision handling in manual operations, bit sockets with all the advantages of the Wera bit technology, brushed chrome-plated finish, holding function for TORX® screws made according to Acument Intellectual Properties specifications. Take it easy tool finder: Colour coding to enable the desired bit socket to be easily located.

			mm	mm	mm	mm
05003059001		TX 10	35,0	12,0	17,5	9,0
05003060001		TX 15	35,0	12,0	17,5	9,0
05003061001		TX 20	35,0	12,0	17,5	9,0
05003062001		TX 25	35,0	12,0	17,5	9,0
05003063001		TX 25	107,0	12,0	17,5	81,0
05003064001		TX 27	35,0	12,0	17,5	9,0
05003065001		TX 27	107,0	12,0	17,5	81,0
05003066001		TX 30	35,0	12,0	17,5	9,0
05003067001		TX 30	107,0	12,0	17,5	81,0
05003068001		TX 40	35,0	12,0	17,5	9,0
05003069001		TX 40	107,0	12,0	17,5	81,0
05003070001		TX 45	38,5	12,0	17,5	12,5
05003071001		TX 45	100,0	12,0	17,5	74,5
05003072001		TX 50	38,5	12,0	17,5	12,5
05003073001		TX 50	100,0	12,0	17,5	74,5

Belt B 3 TORX® HF Zyklop bit socket set with holding function, $\frac{3}{8}$ " drive



9-piece; robust textile socket belt, including snap hook to enable secure fastening to a belt loop or pocket. Non-woven reverse side and hook and loop strips for simple attachment e.g. to a wall, shelf, tool trolley and to the Wera 2go tool transport system. Fast and easy Twist to Unlock mechanism for secure storage and simple removal of the tool sockets.

9 Zyklop bit sockets for TORX® screws, with $\frac{3}{8}$ " drive, with holding function. Take it easy tool finder: Colour coding to enable the desired bit socket to be easily selected.

05003972001			
	8767 B HF	1 x TX 10x35,0; 1 x TX 15x35,0; 1 x TX 20x35,0; 1 x TX 25x35,0; 1 x TX 27x35,0; 1 x TX 30x35,0; 1 x TX 40x35,0; 1 x TX 45x38,5; 1 x TX 50x38,5	
	Belt B 0/9	1 x 45,0x310,0	
	Hook and Loop Fastener Strip 30	1 x 30,0x200,0	

8767 B TORX® HF 1 Zyklop bit socket set with holding function, $\frac{3}{8}$ " drive



6-piece set

Pouch with 100 mm/107 mm bit sockets

6 Zyklop bit sockets for TORX® screws, with $\frac{3}{8}$ " drive, with holding function. Take it easy tool finder: Colour coding to enable the desired bit socket to be easily selected.

05003185001			
	8767 B HF	1 x TX 25x107,0; 1 x TX 27x107,0; 1 x TX 30x107,0; 1 x TX 40x107,0; 1 x TX 45x100,0; 1 x TX 50x100,0	

8740 B HF Zyklop bit socket bit socket with holding function, $\frac{3}{8}$ " drive



Application: Hexagon socket screws

Design: Manual and (non-impact) machine applications, ball intercept ring, knurls at base for precision handling in manual operations, bit sockets with all the advantages of the Wera bit technology, brushed chrome-plated finish, holding function for hexagon socket screws. Take it easy tool finder: Colour coding to enable the desired bit socket to be easily located.

	mm	mm	mm	mm	mm	mm
05003030001	3,0	35,0	12,0	17,5	9,0	
05003031001	4,0	35,0	12,0	17,5	9,0	
05003032001	4,0	107,0	12,0	17,5	81,0	
05003033001	5,0	35,0	12,0	17,5	9,0	
05003034001	5,0	107,0	12,0	17,5	81,0	
05003035001	6,0	35,0	12,0	17,5	9,0	
05003036001	6,0	107,0	12,0	17,5	81,0	
05003037001	7,0	38,5	12,0	17,5	12,5	
05003038001	7,0	100,0	12,0	17,5	74,5	
05003039001	8,0	38,5	12,0	17,5	12,5	
05003040001	8,0	100,0	12,0	17,5	74,5	
05003041001	9,0	38,5	12,0	17,5	12,5	
05003042001	9,0	100,0	12,0	17,5	74,5	
05003043001	10,0	38,5	12,0	17,5	12,5	
05003044001	10,0	100,0	12,0	17,5	74,5	
05003080001		$\frac{1}{8}$ "	35,0	12,0	17,5	9,0
05003081001		$\frac{1}{8}$ "	107,0	12,0	17,5	81,0
05003082001		$\frac{9}{64}$ "	35,0	12,0	17,5	9,0
05003083001		$\frac{5}{32}$ "	35,0	12,0	17,5	9,0
05003084001		$\frac{5}{32}$ "	107,0	12,0	17,5	81,0
05003085001		$\frac{3}{16}$ "	35,0	12,0	17,5	9,0
05003086001		$\frac{3}{16}$ "	107,0	12,0	17,5	81,0
05003087001		$\frac{7}{32}$ "	35,0	12,0	17,5	9,0
05003088001		$\frac{7}{32}$ "	107,0	12,0	17,5	81,0
05003089001		$\frac{1}{4}$ "	35,0	12,0	17,5	9,0
05003090001		$\frac{1}{4}$ "	107,0	12,0	17,5	81,0
05003091001		$\frac{5}{16}$ "	38,5	12,0	17,5	12,5
05003092001		$\frac{5}{16}$ "	100,0	12,0	17,5	74,5
05003093001		$\frac{3}{8}$ "	38,5	12,0	17,5	12,5
05003094001		$\frac{3}{8}$ "	100,0	12,0	17,5	74,5

Tip

Nut extractor tool



This tool enables hexagon nuts to be easily removed from sockets with holding function.

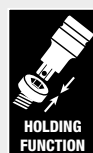
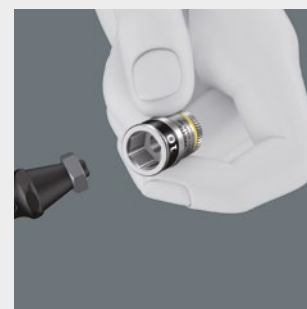
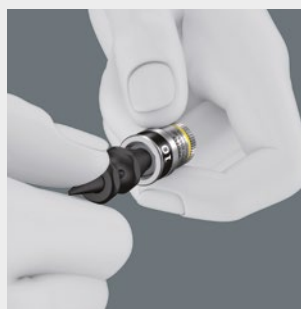

Bit sockets with retaining function for hexagon socket screws

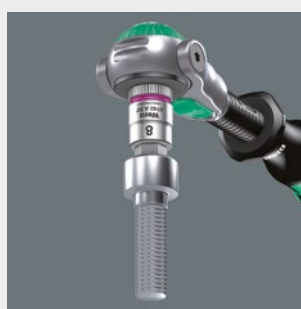

The clamping of the screw is achieved by a flexible locking ball. The holding function is especially helpful in confined, hard-to-reach spaces, where there is no room for a second hand to secure the screw.

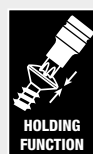

Bit sockets with holding function for TORX® screws

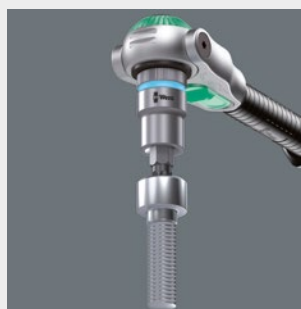

The HF tools developed by Wera are ideal because they feature an optimised geometry of the original TORX® profile. The wedging forces resulting from the surface pressure between the drive tip and the screw profile mean that TORX® screws made according to Acument Intellectual Properties specifications are securely held on the tool!

Zyklop Accessories, $\frac{3}{8}$ "

With amazing product benefits

Belt B 2 Zyklop In-Hex-Plus bit socket set with holding function, $\frac{3}{8}$ " drive



8-piece; robust textile socket belt, including snap hook to enable secure fastening to a belt loop or pocket. Non-woven reverse side and hook and loop strips for simple attachment e.g. to a wall, shelf, tool trolley and to the Wera 2go tool transport system. Fast and easy Twist to Unlock mechanism for secure storage and simple removal of the sockets.

8 bit sockets for hexagon socket screws with $\frac{3}{8}$ " drive with holding function and Hex-Plus high torque geometry. Take it easy tool finder: Colour coding to enable the desired bit socket to be easily selected.

05003971001	
○	8740 B HF 1 x 3,0x35,0; 1 x 4,0x35,0; 1 x 5,0x35,0; 1 x 6,0x35,0; 1 x 7,0x38,5; 1 x 8,0x38,5; 1 x 9,0x38,5; 1 x 10,0x38,5
	Belt B 0/8 1 x 45,0x275,0
	Hook and Loop Fastener Strip 30 1 x 30,0x200,0

8740 B HF 1 Zyklop bit socket set with holding function, $\frac{3}{8}$ " drive



7-piece set

Pouch with 100 mm/107 mm bit sockets

7 Zyklop bit sockets for hexagon socket screws, with $\frac{3}{8}$ " drive, with holding function, Take it easy tool finder: Colour coding to enable the desired bit socket to be easily located.

05003180001	
○	8740 B HF 1 x 4,0x107,0; 1 x 5,0x107,0; 1 x 6,0x107,0; 1 x 7,0x100,0; 1 x 8,0x100,0; 1 x 9,0x100,0; 1 x 10,0x100,0

8740 B HF Imperial 1 Zyklop bit socket set with holding function, $\frac{3}{8}$ " drive



7-piece set

Pouch with 100 mm/107 mm bit sockets

7 Zyklop bit sockets for hexagon socket screws, with $\frac{3}{8}$ " drive, with holding function, Take it easy tool finder: Colour coding to enable the desired bit socket to be easily located.

05003181001	
○	8740 B HF 1 x 1/8"x107,0; 1 x 5/32"x107,0; 1 x 3/16"x107,0; 1 x 7/32"x107,0; 1 x 1/4"x107,0; 1 x 5/16"x100,0; 1 x 3/8"x100,0

Belt B Imperial 1 Zyklop In-Hex-Plus bit socket set with holding function, $\frac{3}{8}$ " drive



8-piece; robust textile socket belt, including snap hook to enable secure fastening to a belt loop or pocket. Non-woven reverse side and hook and loop strips for simple attachment e.g. to a wall, shelf, tool trolley and to the Wera 2go tool transport system. Fast and easy Twist to Unlock mechanism for secure storage and simple removal of the sockets.

8 bit sockets for hexagon socket screws with $\frac{3}{8}$ " drive with holding function and Hex-Plus high torque geometry. Take it easy tool finder: Colour coding to enable the desired bit socket to be easily selected.

05003974001	
○	8740 B HF 1 x 1/8"x35,0; 1 x 9/64"x35,0; 1 x 5/32"x35,0; 1 x 3/16"x35,0; 1 x 7/32"x35,0; 1 x 1/4"x35,0; 1 x 5/16"x38,5; 1 x 3/8"x38,5
	Belt B 0/8 1 x 45,0x275,0
	Hook and Loop Fastener Strip 30 1 x 30,0x200,0

Socket rail B (textile belt), 9 location, unloaded



1 robust textile belt, unloaded, for up to 9 sockets and/or bit sockets, with $\frac{3}{8}$ " drive. Comes with a snap hook to enable secure fastening to a belt loop or pocket. Non-woven reverse side and hook and loop strips for simple attachment e.g. to a wall, shelf, tool trolley and to the Wera 2go tool transport system. Fast and easy Twist to Unlock mechanism for secure storage and simple removal of the sockets.

05003981001		
	Belt B 0/9	1 x 45,0x310,0
	Hook and Loop Fastener Strip 30	1 x 30,0x200,0

Socket rail B (textile belt), 8 location, unloaded



1 robust textile belt, unloaded, for up to 8 sockets and/or bit sockets with $\frac{3}{8}$ " drive. Comes with a snap hook to enable secure fastening to a belt loop or pocket. Nonwoven reverse side and hook and loop strips for simple attachment e.g. to a wall, shelf, tool trolley and to the Wera 2go tool transport system. Fast and easy Twist to Unlock mechanism for secure storage and simple removal of the sockets.

05003980001		
	Belt B 0/8	1 x 45,0x275,0
	Hook and Loop Fastener Strip 30	1 x 30,0x200,0

Tip



Bit sockets with retaining function for hexagon socket screws



The clamping of the screw is achieved by a flexible locking ball. The holding function is especially helpful in confined, hard-to-reach spaces, where there is no room for a second hand to secure the screw.



Textile belt



The textile belt can be attached by means of the nonwoven reverse side and the hook and loop strips e.g. to a wall, shelf, tool trolley and to the Wera 2go tool transport system.

Comes with convenient snap hook

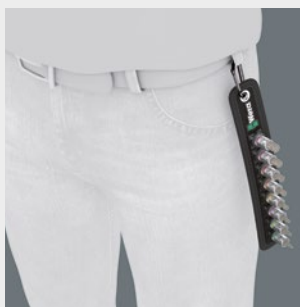

The robust textile belt can be secured to a belt loop or pocket by means of the snap hook.

Zyklop Accessories, $\frac{3}{8}$ "

With amazing product benefits

8796 SB Zyklop "flexible-lock" extension with free-turning sleeve, short, $\frac{3}{8}$ "



Application: $\frac{3}{8}$ " square drive sockets with ball lock

Design: Flexible-lock-system either for permanent interlocking or fast change of accessories, free-turning sleeve for rapid tightening or loosening of screws and nuts, chrome vanadium, brushed chrome-plated finish

05003591001	$\frac{3}{8}$ "	125,0

8794 SB Zyklop extension with free-turning sleeve, short, $\frac{3}{8}$ "



Application: $\frac{3}{8}$ " square drive sockets with ball lock

Design: Easy-to-grip free-turning sleeve for rapid tightening or loosening of screws and nuts, chrome vanadium, brushed chrome-plated finish

05003582001	$\frac{3}{8}$ "	125,0

8784 B1 Zyklop bit adaptor, $\frac{3}{8}$ "



Application: Suitable for $\frac{1}{4}$ " hex bits as per DIN ISO 1173-C 6,3 and E 6,3 and Wera series 1 and 4

Design: Quick-release chuck for fast bit changes, chromium vanadium

05003590001	$\frac{1}{4}$ "	$\frac{3}{8}$ "	44,0

8796 LB Zyklop "flexible-lock" extension with free-turning sleeve, long, $\frac{3}{8}$ "



Application: $\frac{3}{8}$ " square drive sockets with ball lock

Design: Flexible-lock-system either for permanent interlocking or fast change of accessories, free-turning sleeve for rapid tightening or loosening of screws and nuts, chrome vanadium, brushed chrome-plated finish

05003592001	$\frac{3}{8}$ "	200,0

8794 LB Zyklop extension with free-turning sleeve, long, $\frac{3}{8}$ "



Application: $\frac{3}{8}$ " square drive sockets with ball lock

Design: Easy-to-grip free-turning sleeve for rapid tightening or loosening of screws and nuts, chrome vanadium, brushed chrome-plated finish



05003583001	$\frac{3}{8}$ "	200,0

8789 B Zyklop sliding T-handle, 3/8"



Application: 3/8" square drive sockets with ball lock

Design: Sliding drive, chrome vanadium, brushed chrome-plated finish



	 $\frac{3}{8}$ "	$\frac{1}{2}$ " mm
05003581001	$\frac{3}{8}$ "	165,0

8795 B Zyklop universal joint, 3/8"



Application: 3/8" square drive sockets with ball lock

Design: Chrome vanadium/chrome molybdenum, brushed chrome-plated finish



	 $\frac{3}{8}$ "	$\frac{1}{2}$ " mm
05003585001	$\frac{3}{8}$ "	50,0

8794 B Zyklop wobble extension, 3/8"



Application: 3/8" square drive sockets with ball lock

Design: Swivels through 15°, chrome vanadium, brushed chrome-plated finish

	 $\frac{3}{8}$ "	$\frac{1}{2}$ " mm
05003584001	$\frac{3}{8}$ "	76,0

Tip



"Flexible-lock-system"

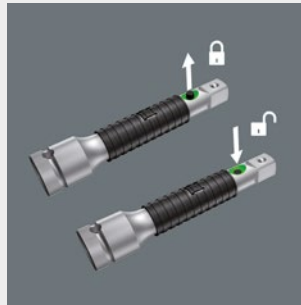

The extensions from the premium lines are also equipped with the unique "flexible-lock-system". By activating this system, attachments can be fixed to the extension permanently – preventing slipping and any unintentional loss of the attachment. When the system is deactivated, the sockets can be attached as usual and changed in a flash.







The free-turning sleeve



The free-turning sleeve effectively speeds up the tightening or loosening of screws and bolts.



Zyklop Ratchets, 1/2"

	Zyklop Speed	190
	Zyklop Hybrid Ratchet	194
	Zyklop Metal Push	198
	Zyklop Metal Switch	200
	Zyklop Accessories	202
	1/2" Koloss ratchet with hammer function	210



The Zyklop Speed Ratchets, 1/2"

5 types of ratchet in 1 tool

8100 SC 6 Zyklop Speed Ratchet Set, 1/2" drive, metric

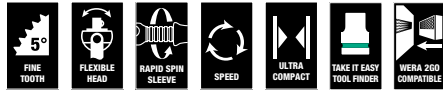

28-piece set; in a surface-preserving, compact and extremely robust textile box; low volume and weight for simplified mobility

1 Zyklop Speed Ratchet with 1/2" drive, 10 Zyklop sockets, 1 Zyklop extension (long) with free-turning sleeve, 1 wobble extension, 1 adaptor with quick-release chuck, 14 bits

05004076001		
⊙	8000 C	1 x 1/2"x277,0
⊙	8790 HMC	1 x 10,0x37,0; 1 x 11,0x37,0; 1 x 12,0x37,0; 1 x 13,0x37,0; 1 x 14,0x37,0; 1 x 15,0x37,0; 1 x 16,0x37,0; 1 x 17,0x37,0; 1 x 18,0x37,0; 1 x 19,0x37,0
⊙	8794 LC	1 x 1/2"x250,0
⊙	8794 C	1 x 1/2"x52,0
⊙	8784 C2	1 x 5/16"x1/2"x50,0
+	851/2 Z PH	1 x PH 2x32; 1 x PH 3x32
+	855/2 Z PZ	1 x PZ 2x32; 1 x PZ 3x32
+	867/2 Z TORX®	1 x TX 20x35; 1 x TX 25x35; 1 x TX 30x35; 1 x TX 40x35; 1 x TX 45x35; 1 x TX 50x35
○	840/2 Z	1 x 5x30; 1 x 6x30; 1 x 8x30; 1 x 10x30

8100 SC 9 Zyklop Speed Ratchet Set, 1/2" drive, imperial

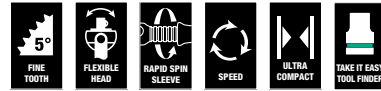

28-piece set; in a surface-preserving, compact and extremely robust textile box; low volume and weight for simplified mobility

1 Zyklop Speed Ratchet with 1/2" drive, 10 Zyklop sockets, 1 Zyklop extension (long) with free-turning sleeve, 1 wobble extension, 1 adaptor with quick-release chuck, 14 bits

05004079001		
⊙	8000 C	1 x 1/2"x277,0
⊙	8790 HMC	1 x 3/8"x37,0; 1 x 7/16"x37,0; 1 x 1/2"x37,0; 1 x 9/16"x37,0; 1 x 19/32"x37,0; 1 x 5/8"x37,0; 1 x 11/16"x37,0; 1 x 3/4"x37,0; 1 x 25/32"x37,0; 1 x 13/16"x37,0
⊙	8794 LC	1 x 1/2"x250,0
⊙	8794 C	1 x 1/2"x52,0
⊙	8784 C2	1 x 5/16"x1/2"x50,0
+	851/2 Z PH	1 x PH 2x32; 1 x PH 3x32
+	855/2 Z PZ	1 x PZ 2x32; 1 x PZ 3x32
+	867/2 Z TORX®	1 x TX 20x35; 1 x TX 25x35; 1 x TX 30x35; 1 x TX 40x35; 1 x TX 45x35; 1 x TX 50x35
○	840/2 Z	1 x 7/32"x30; 1 x 1/4"x30; 1 x 5/16"x30; 1 x 3/8"x30

8100 SC 2 Zyklop Speed Ratchet Set, 1/2" drive, metric

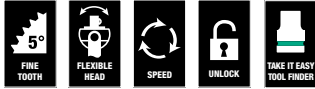

37-piece set in strong metal case

1 Zyklop ratchet with 1/2" drive, 17 Zyklop sockets (metric),

2 Zyklop "flexible-lock" extensions (short and long) with free-tuning sleeve, 1 sliding T-handle, 1 universal joint, 1 wobble extension, 1 adaptor with quick-release chuck, 13 bits

05003645001		
○	8000 C	1 x 1/2"x277,0
●	8790 HMC	1 x 10,0x37,0; 1 x 11,0x37,0; 1 x 12,0x37,0; 1 x 13,0x37,0; 1 x 14,0x37,0; 1 x 15,0x37,0; 1 x 16,0x37,0; 1 x 17,0x37,0; 1 x 18,0x37,0; 1 x 19,0x37,0; 1 x 20,0x37,0; 1 x 21,0x37,0; 1 x 22,0x37,0; 1 x 24,0x37,0; 1 x 27,0x40,0; 1 x 30,0x42,0; 1 x 32,0x42,0
○	8789 C	1 x 1/2"x250,0
○	8794 C	1 x 1/2"x52,0
○	8795 C	1 x 1/2"x69,0
○	8784 C2	1 x 5/16"x1/2"x50,0
○	8796 SC	1 x 1/2"x125,0
○	8796 LC	1 x 1/2"x250,0
○	840/2 Z	1 x 5x30; 1 x 6x30; 1 x 8x30; 1 x 10x30
+	851/2 Z PH	1 x PH 3x32
+	855/2 Z PZ	1 x PZ 3x32
⊗	867/2 Z TORX®	1 x TX 20x35; 1 x TX 25x35; 1 x TX 30x35; 1 x TX 40x35; 1 x TX 45x35; 1 x TX 50x35; 1 x TX 55x35

Tip

Zyklop "6 in 1"



1. Fine-tooth ratchet
2. Flex-head ratchet
3. Angle ratchet
4. Quick-release ratchet
5. Power ratchet
6. Screwdriver

New set concept



The textile boxes offer dramatically improved portability, and are space-saving to boot! This means you can now carry the same collection of tools, in a much more compact and comfortable package.



The hassle of running back and forth for the right tools has now become a thing of the past. And the much lower weight of a set makes carrying more convenient than ever before. The textile box including the tool will even survive a fall undamaged.



"Take it easy"



"Take it easy" tool finder system – with profile and size colour-coding for quick and easy tool selection. Colour-coded system for hexagon drive screws (L-Keys, Zyklop bit sockets), external hex drive screws and nuts (Joker wrenches, Zyklop sockets and Zyklop bit sockets with holding function), and TORX® drive screws (L-Keys, Zyklop bit sockets).

The Zyklop Speed Ratchets, 1/2"

5 types of ratchet in 1 tool

8100 SC 4 Zyklop Speed Ratchet Set, 1/2" drive, imperial

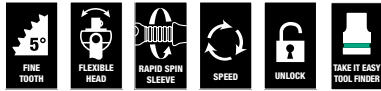

38-piece set in strong metal case

1 Zyklop ratchet with 1/2" drive, 18 Zyklop sockets (imperial),
2 Zyklop "flexible-lock" extensions (short and long) with free-tuning sleeve,
1 sliding T-handle, 1 universal joint, 1 wobble extension, 1 adaptor with
quick-release chuck, 13 bits

05003647001		
⊙	8000 C	1 x 1/2"x277,0
⊙	8790 HMC	1 x 3/8"x37,0; 1 x 7/16"x37,0; 1 x 1/2"x37,0; 1 x 9/16"x37,0; 1 x 19/32"x37,0; 1 x 5/8"x37,0; 1 x 11/16"x37,0; 1 x 3/4"x37,0; 1 x 25/32"x37,0; 1 x 13/16"x37,0; 1 x 7/8"x37,0; 1 x 15/16"x37,0; 1 x 31/32"x37,0; 1 x 1"x40,0; 1 x 1 1/16"x40,0; 1 x 1 1/8"x40,0; 1 x 1 3/16"x42,0; 1 x 1 1/4"x42,0
⊙	8789 C	1 x 1/2"x250,0
⊙	8794 C	1 x 1/2"x52,0
⊙	8795 C	1 x 1/2"x69,0
⊙	8784 C2	1 x 5/16"x1 1/2"x50,0
⊙	8796 SC	1 x 1/2"x125,0
⊙	8796 LC	1 x 1/2"x250,0
+	851/2 Z PH	1 x PH 3x32
+	855/2 Z PZ	1 x PZ 3x32
⊙	867/2 Z TORX®	1 x TX 20x35; 1 x TX 25x35; 1 x TX 30x35; 1 x TX 40x35; 1 x TX 45x35; 1 x TX 50x35; 1 x TX 55x35
⊙	840/2 Z	1 x 7/32"x30; 1 x 1/4"x30; 1 x 5/16"x30; 1 x 3/8"x30

8000 C Zyklop Speed Ratchet with 1/2" drive



Application: 1/2" square drive sockets and 1/2" adapters with square drive, equipped with ball lock

Design: Flywheel design and easy-to-grip free-turning sleeve for faster work, swivel ratchet head, defined lock positions at 0° and 90° to the left and right as well as at 15° before 90° inwards, at 0° it can be used like a conventional screwdriver, pushbutton release, left/right switchover, fine-tooth design, small return angle of 5°

Handle: Multi-component Kraftform handle ensures minimum fatigue

	mm	
05003600001	1/2"	277,0

8000 C SB Zyklop Speed Ratchet with 1/2" drive

	1 x 1/2"x277,0	4013288 128058
05073262001		





The Zyklop Hybrid Ratchet, 1/2"



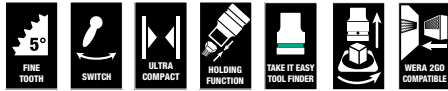

Combines robustness, slim design, and little weight

8006 SC 1 Zyklop Hybrid Ratchet Set, 1/2" drive, metric



13-piece set; in a surface-preserving, compact and extremely robust textile box; low volume and weight for simplified mobility

1 Zyklop Hybrid Ratchet with 1/2" drive, 10 Zyklop sockets with holding function, 1 Zyklop Hybrid Extension with release pin, 1 Zyklop extension (long with free-turning sleeve)

	
05004090001	
	8006 C 1 x 1/2"x281,0
	8797 C 1 x 271,0
	8794 LC 1 x 1/2"x250,0
	8790 HMC HF 1 x 10,0x37,0; 1 x 11,0x37,0; 1 x 12,0x37,0; 1 x 13,0x37,0; 1 x 14,0x37,0; 1 x 15,0x37,0; 1 x 16,0x37,0; 1 x 17,0x37,0; 1 x 18,0x37,0; 1 x 19,0x37,0



Zyklop Hybrid Set



Application: Ratchet function for 1/2" square sockets and 1/2" adaptors with square drive, equipped with ball lock

Design: Fine-tooth mechanism with 72 teeth for a return angle of only 5°; switch lever for convenient change of direction; secure socket locking function

Handle: Multi-component Kraftform handle for optimum pressure, impact and tensile loads, handle end designed for connection of Zyklop Hybrid extension 8797 C

	
05004095001	
	8006 C 1 x 1/2"x281,0
	8797 C 1 x 271,0





Tip



“Take it easy”



“Take it easy” tool finder system – with profile and size colour-coding for quick and easy tool selection. Colour-coded system for hexagon drive screws (L-Keys, Zyklop bit sockets), external hex drive screws and nuts (Joker wrenches, Zyklop sockets and Zyklop bit sockets with holding function), and TORX® drive screws (L-Keys, Zyklop bit sockets).



Secure hold and easy removal



The all new smooth turning mechanism guarantees both secure and rattle-free storage, yet allows easy removal of the tool.



Sockets with retaining function for hexagon headed bolts, screws and nuts



The clamping of the screw is achieved by two flexible locking balls and a robust, permanently elastic, heat-shrunk tubing. The tubing is effectively protected against mechanical wear and tear by a steel ring. The holding function is especially helpful in confined, hard-to-reach spaces, where there is no room for a second hand to secure the screw.

The Zyklop Hybrid Ratchet, 1/2"

Combines robustness, slim design, and little weight

8006 C Zyklop Hybrid Ratchet with switch lever and 1/2" drive



Application: 1/2" square sockets as well as for 1/2" adaptors with square drive, with ball locking device

Design: Fine-tooth mechanism with 72 teeth for a return angle of only 5°; switch lever for convenient change of direction; secure socket locking function

Handle: Multi-component Kraftform handle for optimum pressure and tensile loads, handle end designed for connection of Zyklop Hybrid extension

	mm	mm	mm	mm
05003780001	1/2"	281,0	34	37

8797 C Zyklop Hybrid extension



Application: Extension for use with Wera Zyklop Hybrid 8006 C to increase torque transfer

Design: Tough, tempered Cr-Mo steel

Handle: Multi-component Kraftform handle for optimum pressure and tensile loads; with extension release pin

	mm	mm
05003781001	134,0	137

Unlocking pin



Application: For unlocking the connection between the Koloss Ratchet 8002 C and the Koloss Extension 8780 C as well as the connection between Zyklop Hybrid Ratchet 8006 C and the Zyklop Hybrid Extension 8797 C

Design: Zinc die casting

	mm
05136400001	40,5



The Zyklop Metal Ratchets Push, 1/2"

With push-through square

8100 SC 7 Zyklop Metal Ratchet Set with push-through square, 1/2" drive, metric

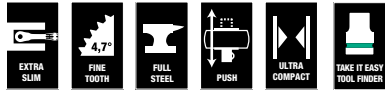

28-piece set; in a surface-preserving, compact and extremely robust textile box; low volume and weight for simplified mobility

1 Zyklop Metal Ratchet with push-through square and 1/2" drive, 10 Zyklop sockets, 1 Zyklop extension (long) with free-turning sleeve, 1 wobble extension, 1 adaptor with quick-release chuck, 14 bits

05004077001		
⊙	8003 C	1 x 1/2"x281,0
⊙	8790 HMC	1 x 10,0x37,0; 1 x 11,0x37,0; 1 x 12,0x37,0; 1 x 13,0x37,0; 1 x 14,0x37,0; 1 x 15,0x37,0; 1 x 16,0x37,0; 1 x 17,0x37,0; 1 x 18,0x37,0; 1 x 19,0x37,0
⊙	8794 LC	1 x 1/2"x250,0
⊙	8794 C	1 x 1/2"x52,0
⊙	8784 C2	1 x 5/16"x1/2"x50,0
+	851/2 Z PH	1 x PH 2x32; 1 x PH 3x32
+	867/2 Z TORX®	1 x TX 20x35; 1 x TX 25x35; 1 x TX 27x35; 1 x TX 30x35; 1 x TX 40x35; 1 x TX 45x35; 1 x TX 50x35; 1 x TX 55x35
○	840/2 Z	1 x 5x30; 1 x 6x30; 1 x 8x30; 1 x 10x30

8100 SC 10 Zyklop Metal Ratchet Set with push-through square, 1/2" drive, imperial

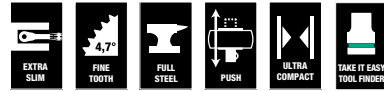

28-piece set; in a surface-preserving, compact and extremely robust textile box; low volume and weight for simplified mobility

1 Zyklop Metal Ratchet with push-through square and 1/2" drive, 10 Zyklop sockets, 1 Zyklop extension (long) with free-turning sleeve, 1 wobble extension, 1 adaptor with quick-release chuck, 14 bits



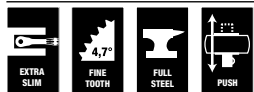

05004080001		
⊙	8003 C	1 x 1/2"x281,0
⊙	8790 HMC	1 x 3/8"x37,0; 1 x 7/16"x37,0; 1 x 1/2"x37,0; 1 x 9/16"x37,0; 1 x 19/32"x37,0; 1 x 5/8"x37,0; 1 x 11/16"x37,0; 1 x 3/4"x37,0; 1 x 25/32"x37,0; 1 x 13/16"x37,0
⊙	8794 LC	1 x 1/2"x250,0
⊙	8794 C	1 x 1/2"x52,0
⊙	8784 C2	1 x 5/16"x1/2"x50,0
+	851/2 Z PH	1 x PH 2x32; 1 x PH 3x32
+	867/2 Z TORX®	1 x TX 20x35; 1 x TX 25x35; 1 x TX 27x35; 1 x TX 30x35; 1 x TX 40x35; 1 x TX 45x35; 1 x TX 50x35; 1 x TX 55x35
○	840/2 Z	1 x 7/32"x30; 1 x 1/4"x30; 1 x 5/16"x30; 1 x 3/8"x30

8003 C Zyklop Metal Ratchet with push-through square and 1/2" drive



Application: 1/2" square sockets as well as for 1/2" adaptors with square drive, with ball locking device

Design: Forged, full metal ratchet (chrome-molybdenum) that is extremely robust with a long service life; slim design to enable work in very confined spaces; the dual-ratchet-teeth design means that a 76 fine-toothing division can be achieved from the 38 robust teeth with a return angle of only 4.7°; simple direction change with the undetachable push-through square and very secure socket lock mechanism

				
	mm	mm	mm	mm
05004063001	1/2"	281,0	36	37

Tip

The Zyklop Metal Ratchets Push



Forged, full metal ratchet (chrome-molybdenum) that is extremely robust with a long service life; slim design to enable work in very confined spaces.

Textile boxes



The textile boxes offer dramatically improved portability, and are space-saving to boot!

This means you can now carry the same collection of tools, in a much more compact and comfortable package. The hassle of running back and forth for the right tools has now become a thing of the past. And the much lower weight of a set makes carrying more convenient than ever before. The textile box including the tool will even survive a fall undamaged. And: it leaves absolutely no signs of scratches on sensitive surfaces.



“Take it easy”



“Take it easy” tool finder system – with profile and size colour-coding for quick and easy tool selection. Colour-coded system for hexagon drive screws (L-Keys, Zyklop bit sockets), external hex drive screws and nuts (Joker wrenches, Zyklop sockets and Zyklop bit sockets with holding function), and TORX® drive screws (L-Keys, Zyklop bit sockets).

The Zyklop Metal Ratchets Switch, 1/2"

With switch lever

8100 SC 8 Zyklop Metal Ratchet Set with switch lever, 1/2" drive, metric



28-piece set; in a surface-preserving, compact and extremely robust textile box; low volume and weight for simplified mobility

1 Zyklop Metal Ratchet with switch lever and 1/2" drive, 10 Zyklop sockets, 1 Zyklop extension (long) with free-turning sleeve, 1 wobble extension, 1 adaptor with quick-release chuck, 14 bits

05004078001	
○	8004 C 1 x 1/2"x281,0
●	8790 HMC 1 x 10,0x37,0; 1 x 11,0x37,0; 1 x 12,0x37,0; 1 x 13,0x37,0; 1 x 14,0x37,0; 1 x 15,0x37,0; 1 x 16,0x37,0; 1 x 17,0x37,0; 1 x 18,0x37,0; 1 x 19,0x37,0
⊗	8794 LC 1 x 1/2"x250,0
⊗	8794 C 1 x 1/2"x52,0
⊗	8784 C2 1 x 5/16"x1/2"x50,0
+	851/2 Z PH 1 x PH 2x32; 1 x PH 3x32
⊗	867/2 Z TORX® 1 x TX 20x35; 1 x TX 25x35; 1 x TX 27x35; 1 x TX 30x35; 1 x TX 40x35; 1 x TX 45x35; 1 x TX 50x35; 1 x TX 55x35
○	840/2 Z 1 x 5x30; 1 x 6x30; 1 x 8x30; 1 x 10x30

8100 SC 11 Zyklop Metal Ratchet Set with switch lever, 1/2" drive, imperial

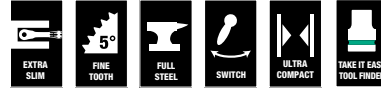

28-piece set; in a surface-preserving, compact and extremely robust textile box; low volume and weight for simplified mobility

1 Zyklop Metal Ratchet with switch lever and 1/2" drive, 10 Zyklop sockets, 1 Zyklop extension (long) with free-turning sleeve, 1 wobble extension, 1 adaptor with quick-release chuck, 14 bits

05004081001	
○	8004 C 1 x 1/2"x281,0
●	8790 HMC 1 x 3/8"x37,0; 1 x 7/16"x37,0; 1 x 1/2"x37,0; 1 x 9/16"x37,0; 1 x 19/32"x37,0; 1 x 5/8"x37,0; 1 x 11/16"x37,0; 1 x 3/4"x37,0; 1 x 25/32"x37,0; 1 x 13/16"x37,0
⊗	8794 LC 1 x 1/2"x250,0
⊗	8794 C 1 x 1/2"x52,0
⊗	8784 C2 1 x 5/16"x1/2"x50,0
+	851/2 Z PH 1 x PH 2x32; 1 x PH 3x32
⊗	867/2 Z TORX® 1 x TX 20x35; 1 x TX 25x35; 1 x TX 27x35; 1 x TX 30x35; 1 x TX 40x35; 1 x TX 45x35; 1 x TX 50x35; 1 x TX 55x35
○	840/2 Z 1 x 7/32"x30; 1 x 1/4"x30; 1 x 5/16"x30; 1 x 3/8"x30

8004 C Zyklop Metal Ratchet with switch lever and 1/2" drive



Application: 1/2" square sockets as well as for 1/2" adaptors with square drive, with ball locking device

Design: Forged, full metal ratchet (chrome-molybdenum) that is extremely robust with a long service life; slim design to enable work in very confined spaces; fine-tooth mechanism with 72 teeth for a return angle of only 5°; switch lever for convenient change of direction; secure socket locking function

		mm	mm	mm
05004064001	1/2"	281,0	34	37

Tip

The Zyklop Metal Ratchets Switch



Extremely slim. Long leverage. Very robust without any torque limitation. Forged, full metal ratchet out of chrome molybdenum.

Textile boxes



The textile boxes offer dramatically improved portability, and are space-saving to boot!

This means you can now carry the same collection of tools, in a much more compact and comfortable package. The hassle of running back and forth for the right tools has now become a thing of the past. And the much lower weight of a set makes carrying more convenient than ever before. The textile box including the tool will even survive a fall undamaged. And: it leaves absolutely no signs of scratches on sensitive surfaces.



“Take it easy”



“Take it easy” tool finder system – with profile and size colour-coding for quick and easy tool selection. Colour-coded system for hexagon drive screws (L-Keys, Zyklop bit sockets), external hex drive screws and nuts (Joker wrenches, Zyklop sockets and Zyklop bit sockets with holding function), and TORX® drive screws (L-Keys, Zyklop bit sockets).

Zyklop Accessories, 1/2"

With amazing product benefits

HMC Zyklop socket with 1/2" drive



Application: Hexagon headed bolts, screws and nuts

Design: Manual and (non-impact) machine applications, ball intercept ring, knurls at base for precision handling in manual operations, chrome vanadium, brushed chrome-plated finish. Colour coding to enable the desired bit socket to be easily located

	mm	mm	mm	mm	mm	mm
05003601001	10,0	37,0	15,5	24,0	17,0	
05003602001	11,0	37,0	16,5	24,0	17,0	
05003603001	12,0	37,0	17,5	24,0	17,0	
05003604001	13,0	37,0	19,0	24,0	17,0	
05003605001	14,0	37,0	20,0	24,0	17,0	
05003606001	15,0	37,0	21,0	24,0	17,0	
05003607001	16,0	37,0	22,5	24,0	17,0	
05003608001	17,0	37,0	24,0	26,0	17,0	
05003609001	18,0	37,0	25,0	26,0	17,0	
05003610001	19,0	37,0	26,5	26,0	20,0	
05003611001	20,0	37,0	28,0	26,0	20,0	
05003612001	21,0	37,0	29,0	26,0	20,0	
05003613001	22,0	37,0	30,5	26,0	20,0	
05003614001	24,0	37,0	33,0	28,0	20,0	
05003615001	27,0	40,0	36,5	32,0	23,0	
05003616001	30,0	42,0	40,0	34,0	25,0	
05003617001	32,0	42,0	42,0	36,0	25,0	
05003618001	3/8"	37,0	15,5	24,0	17,0	
05003619001	7/16"	37,0	16,5	24,0	17,0	
05003620001	1/2"	37,0	19,0	24,0	17,0	
05003621001	9/16"	37,0	20,0	24,0	17,0	
05003622001	19/32"	37,0	21,0	24,0	17,0	
05003623001	5/8"	37,0	22,5	24,0	17,0	
05003624001	11/16"	37,0	25,5	26,0	17,0	
05003625001	3/4"	37,0	26,5	26,0	20,0	
05003626001	25/32"	37,0	28,0	26,0	20,0	
05003627001	13/16"	37,0	29,0	26,0	20,0	
05003628001	7/8"	37,0	30,5	26,0	20,0	
05003629001	15/16"	37,0	33,0	28,0	20,0	
05003630001	31/32"	37,0	33,0	28,0	20,0	
05003631001	1"	40,0	36,5	32,0	23,0	
05003632001	1 1/16"	40,0	36,5	32,0	23,0	
05003633001	1 1/8"	40,0	40,0	34,0	23,0	
05003634001	1 3/16"	42,0	40,0	34,0	25,0	
05003635001	1 1/4"	42,0	42,0	36,0	25,0	

8790 HMC HF Zyklop socket with 1/2" drive with holding function



Application: Hexagon headed bolts, screws and nuts

Design: Manual and (non-impact) machine applications, ball intercept ring, knurls at base for precision handling in manual operations, with holding function, chrome vanadium, brushed chrome-plated finish. Colour coding to enable the desired bit socket to be easily located

	mm	mm	mm	mm	mm
05003730001	10,0	37,0	17,8	23,5	10,4
05003731001	11,0	37,0	18,8	23,5	10,4
05003732001	12,0	37,0	20,4	23,5	11,4
05003733001	13,0	37,0	21,4	23,5	11,4
05003734001	14,0	37,0	22,6	23,5	11,4
05003735001	15,0	37,0	23,6	23,5	12,0
05003736001	16,0	37,0	25,0	23,5	12,0
05003737001	17,0	37,0	26,8	23,5	12,5
05003738001	18,0	37,0	28,0	23,5	12,5
05003739001	19,0	37,0	29,2	23,5	14,0

8790 HF 1 Zyklop socket set with holding function



10-piece set; in a surface-preserving, compact and extremely robust textile box; low volume and weight for simplified mobility

10 Zyklop sockets with 1/2" drive with holding function

05004203001	8790 HMC HF	1 x 10,0x37,0; 1 x 11,0x37,0; 1 x 12,0x37,0; 1 x 13,0x37,0; 1 x 14,0x37,0; 1 x 15,0x37,0; 1 x 16,0x37,0; 1 x 17,0x37,0; 1 x 18,0x37,0; 1 x 19,0x37,0
-------------	-------------	--

Nut Extractor



Tool made out of synthetic plastic material (TPE) for the simple removal of nuts from sockets with holding function.

	mm	mm
05050005001	14,0	43,0

Tip



Sockets with retaining function for hexagon headed bolts, screws and nuts



The clamping of the screw is achieved by two flexible locking balls and a robust, permanently elastic, heat-shrunk tubing. The tubing is effectively protected against mechanical wear and tear by a steel ring. The holding function is especially helpful in confined, hard-to-reach spaces, where there is no room for a second hand to secure the screw.



Secure hold and easy removal

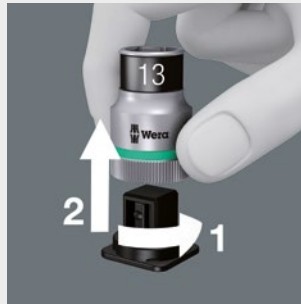

The all new smooth turning mechanism of the Zyklop HF Socket sets guarantees both secure and rattle-free storage, yet allows easy removal of the tool.

Nut extractor tool

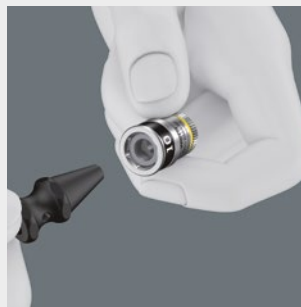

This tool enables hexagon nuts to be easily removed from sockets with holding function.

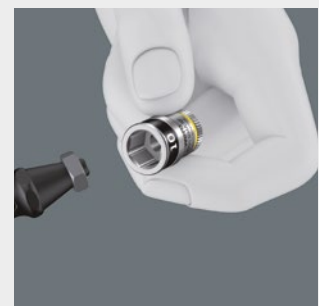
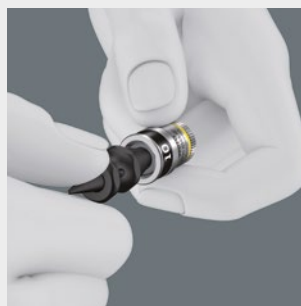

Zyklop Accessories, 1/2"

With amazing product benefits

8767 C HF TORX® Zyklop bit socket with 1/2" drive with holding function

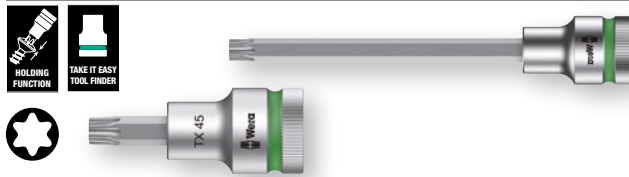

Application: TORX® socket screws

Design: Manual and (non-impact) machine applications, ball intercept ring, knurls at base for precision handling in manual operations, chrome vanadium, brushed chrome-plated finish, holding function for TORX® screws made according to Acument Intellectual Properties specifications. Take it easy tool finder: Colour coding to enable the desired bit socket to be easily located

				mm	mm	mm	mm
05003830001				60,0	16,4	23,5	21,5
05003850001				140,0	16,4	23,5	101,5
05003831001				60,0	16,4	23,5	21,5
05003851001				140,0	16,4	23,5	101,5
05003832001				60,0	16,4	23,5	21,5
05003852001				140,0	16,4	23,5	101,5
05003833001				60,0	16,4	23,5	21,5
05003853001				140,0	16,4	23,5	101,5
05003834001				60,0	16,4	23,5	21,5
05003854001				140,0	16,4	23,5	101,5
05003835001				60,0	16,4	23,5	21,5
05003855001				140,0	16,4	23,5	101,5
05003836001				60,0	21,4	23,5	21,5
05003856001				140,0	21,4	23,5	101,5
05003837001				60,0	21,4	23,5	21,5
05003857001				140,0	21,4	23,5	101,5
05003838001				60,0	21,4	23,5	21,5
05003858001				140,0	21,4	23,5	101,5

8767 C TORX® HF 1 Zyklop bit socket set with 1/2" drive, with holding function



9-piece set; in a surface-preserving, compact and extremely robust textile box; low volume and weight for simplified mobility

9 Zyklop bit sockets for TORX® screws, with 1/2" drive, with holding function

05004202001		
	8767 C HF	1 x TX 20x60; 1 x TX 25x60; 1 x TX 27x60; 1 x TX 30x60; 1 x TX 40x60; 1 x TX 45x60; 1 x TX 50x60; 1 x TX 55x60; 1 x TX 60x60

8767 C TORX® HF 2 Zyklop bit socket set with 1/2" drive, with holding function



6-piece set; in a surface-preserving, compact and extremely robust textile box; low volume and weight for simplified mobility

6 Zyklop bit sockets, 140 mm long, for TORX® screws, with 1/2" drive, with holding function

05004211001		
	8767 C HF	1 x TX 20x140; 1 x TX 25x140; 1 x TX 27x140; 1 x TX 30x140; 1 x TX 40x140; 1 x TX 45x140

8767 C TORX® HF 3 Zyklop bit socket set with 1/2" drive, with holding function



9-piece set; in a surface-preserving, compact and extremely robust textile box; low volume and weight for simplified mobility

9 Zyklop bit sockets, 140 mm long, for TORX® screws, with 1/2" drive, with holding function

05004212001	
	8767 C HF 1 x TX 20x140; 1 x TX 25x140; 1 x TX 27x140; 1 x TX 30x140; 1 x TX 40x140; 1 x TX 45x140; 1 x TX 50x140; 1 x TX 55x140; 1 x TX 60x140

8740 C HF 1 Zyklop bit socket set with 1/2" drive with holding function



9-piece set; in a surface-preserving, compact and extremely robust textile box; low volume and weight for simplified mobility

9 Zyklop bit sockets for hexagon socket screws, with 1/2" drive, with holding function

05004201001	
	8740 C HF 1 x 4,0x60,0; 1 x 5,0x60,0; 1 x 6,0x60,0; 1 x 7,0x60,0; 1 x 8,0x60,0; 1 x 10,0x60,0; 1 x 12,0x60,0; 1 x 14,0x60,0; 1 x 17,0x60,0

Tip



Bit sockets with holding function for TORX® screws



The HF tools developed by Wera are ideal because they feature an optimised geometry of the original TORX® profile. The wedging forces resulting from the surface pressure between the drive tip and the screw profile mean that TORX® screws made according to Acument Intellectual Properties specifications are securely held on the tool!



Bit sockets with retaining function for hexagon socket screws



The clamping of the screw is achieved by a flexible locking ball. The holding function is especially helpful in confined, hard-to-reach spaces, where there is no room for a second hand to secure the screw.



Secure hold and easy removal



The all new smooth turning mechanism of the Zyklop HF Socket sets guarantees both secure and rattle-free storage, yet allows easy removal of the tool.

Zyklop Accessories, 1/2"



With amazing product benefits

8740 C HF 2 Zyklop bit socket set with 1/2" drive, with holding function



9-piece set; in a surface-preserving, compact and extremely robust textile box; low volume and weight for simplified mobility

9 Zyklop bit sockets, 140 mm long, for hexagon socket screws, with 1/2" drive, with holding function



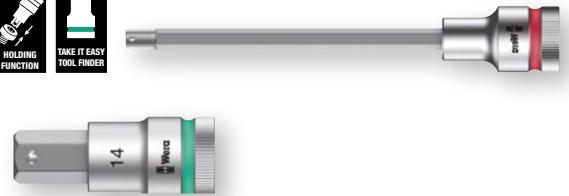
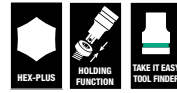

	
05004210001	
	8740 C HF 1 x 4,0x140,0; 1 x 5,0x140,0; 1 x 6,0x140,0; 1 x 7,0x140,0; 1 x 8,0x140,0; 1 x 10,0x140,0

8740 C HF Zyklop bit socket with 1/2" drive with holding function



Application: Hexagon socket screws

Design: Manual and (non-impact) machine applications, ball intercept ring, knurls at base for precision handling in manual operations, chrome vanadium, brushed chrome-plated finish, holding function for hexagon socket screws. Colour coding to enable the desired bit socket to be easily located

					
	mm	mm	mm	mm	mm
05003820001	4,0	60,0	14,0	21,5	21,5
05003840001	4,0	140,0	14,0	21,5	101,5
05003821001	5,0	60,0	14,0	21,5	21,5
05003841001	5,0	140,0	14,0	21,5	101,5
05003822001	6,0	60,0	14,0	21,5	21,5
05003842001	6,0	140,0	14,0	21,5	101,5
05003823001	7,0	60,0	14,0	23,5	21,5
05003843001	7,0	140,0	14,0	23,5	101,5
05003824001	8,0	60,0	16,0	23,5	21,5
05003844001	8,0	140,0	16,0	23,5	101,5
05003825001	10,0	60,0	16,0	23,5	21,5
05003845001	10,0	140,0	16,0	23,5	101,5
05003826001	12,0	60,0	21,0	23,5	23,0
05003827001	14,0	60,0	22,0	23,5	23,0
05003828001	17,0	60,0	24,5	25,5	23,0
05003829001	19,0	60,0	26,5	27,5	23,0



Zyklop Accessories, 1/2"

With amazing product benefits

8796 SC Zyklop „flexible-lock“ extension with free-turning sleeve, short, 1/2"



Application: 1/2" square drive sockets with ball lock

Design: Flexible lock system either for permanent interlocking or fast change of accessories, free-turning sleeve for rapid tightening or loosening of screws and nuts, chrome vanadium, brushed chrome-plated finish

		mm
05003642001	1/2"	125,0

8794 SC Zyklop extension with free-turning sleeve, short, 1/2"



Application: 1/2" square drive sockets with ball lock

Design: Easy-to-grip free-turning sleeve for rapid tightening or loosening of screws and nuts, chrome vanadium, brushed chrome-plated finish

		mm
05003637001	1/2"	125,0

8796 LC Zyklop "flexible-lock" extension with free-turning sleeve, long, 1/2"



Application: 1/2" square drive sockets with ball lock

Design: Flexible lock system either for permanent interlocking or fast change of accessories, free-turning sleeve for rapid tightening or loosening of screws and nuts, chrome vanadium, brushed chrome-plated finish

		mm
05003643001	1/2"	250,0

8794 LC Zyklop extension with free-turning sleeve, long, 1/2"



Application: 1/2" square drive sockets with ball lock

Design: Easy-to-grip free-turning sleeve for rapid tightening or loosening of screws and nuts, chrome vanadium, brushed chrome-plated finish

		mm
05003638001	1/2"	250,0

8789 C Zyklop sliding T-handle, 1/2"



Application: 1/2" square drive sockets with ball lock

Design: Sliding drive, chrome vanadium, brushed chrome-plated finish

		↓ mm
05003636001	1/2"	250,0

8784 C2 Zyklop Bit adaptor, 1/2", 5/16"



Application: Suitable for 5/16" hex bits as per DIN ISO 1173-C 8 and Wera series 2

Design: Quick-release chuck for fast bit changes, chromium vanadium

			↓ mm
05003641001	5/16"	1/2"	50,0

8795 C Zyklop universal joint, 1/2"



Application: 1/2" square drive sockets with ball lock

Design: Chrome vanadium/chrome molybdenum, brushed chrome-plated finish

		↓ mm
05003640001	1/2"	69,0

8794 C Zyklop wobble extension, 1/2"

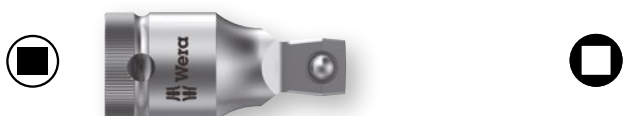

Application: 1/2" square drive sockets with ball lock

Design: Swivels through 15°, chrome vanadium, brushed chrome-plated finish

		↓ mm
05003639001	1/2"	52,0

The Koloss

Obviously, many users also apply their ratchet as a hammer. This often ruins the ratchet and is dangerous to boot.

That is why we developed the heavy-duty Koloss ratchet whose mechanism is extremely robust, and nearly impossible to destroy through impact.

The Koloss is so robust that it can even be used safely with its extension element.



Non-removable sealed and hardened square drive for tough jobs.



Changing the ratchet direction using a hardened push-through square drive ensures great resilience, since there is no susceptible switching mechanism that could be damaged by hammer blows. This is far more robust than a forward/reverse switch.

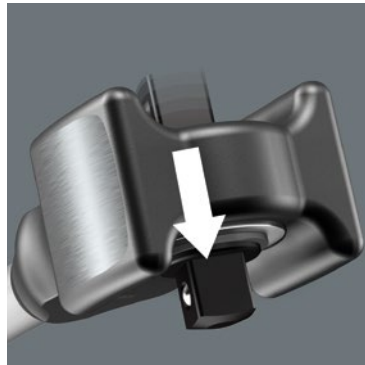

Tubular shaft minimises impact vibrations.

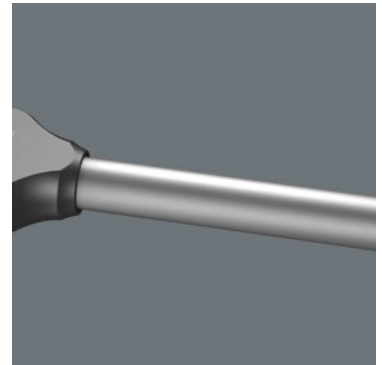

Dry-fined hammer face: used with rubber pad attachments to protect materials and surfaces.



The drop-forged hammer head is permanently pinned to the shaft in a form-fit joint. This guarantees an almost non-detachable positioning of the hammer head on the handle.



Dual ratchet teeth: gives the robust 30 saw teeth the precision engineering effect of 60 fine teeth with a 6° return angle.



Newly developed, multi-component Kraftform handle that satisfies both the hammer and ratchet application requirements.

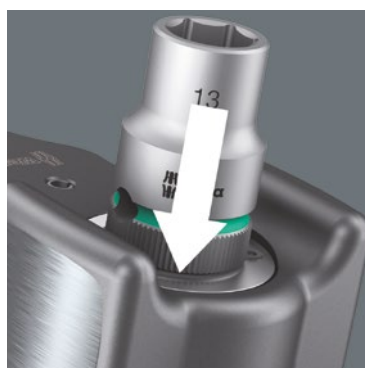

Sockets and accessories can simply and quickly be attached.



The degree of torque applied can be increased by using the Wera extension Koloss 8002 C.

Koloss

This ratchet is a real hit! And that is for sure!

8002 C Koloss All Inclusive Set with 1/2" drive



Application: Ratchet function for 1/2" square sockets and 1/2" adaptors with square drive, equipped with ball lock, hammer function e.g. to align work pieces

Design: Push-through square drive for forward and reverse operation, fine-tooth ratchet mechanism, small return angle of 6°, can transfer at least 600 Nm of torque, tubular shaft to minimise impact vibrations, drop-forged hammer head, positively pinned, ground striking face

Handle: Multi-component Kraftform handle for optimum pressure, impact and tensile loads, handle end designed for connection of Koloss extension 8780 C and Koloss centering pin 8781 C

05133862001		
	8002 C	1 x 1/2"x341,0
	8782 C	1 x 2x50,0
	8780 C	1 x 341,0x137
	8000 E	1 x Unlocking pin
	8000 HLF	1 x Holster

8002 C Koloss 1/2" with 1/2" drive



Application: Ratchet function for 1/2" square sockets and 1/2" adaptors with square drive, equipped with ball lock, hammer function e.g. to align work pieces

Design: Push-through square drive for forward and reverse operation, fine-tooth ratchet mechanism, small return angle of 6°, can transfer at least 600 Nm of torque, tubular shaft to minimise impact vibrations, drop-forged hammer head, positively pinned, ground striking face

Handle: Multi-component Kraftform handle for optimum pressure, impact and tensile loads, handle end designed for connection of Koloss extension 8780 C and Koloss centering pin 8781 C

05003692001		
	8002 C	1 x 1/2"x341,0
	8782 C	1 x 2x50,0
	8000 HLF	1 x Holster

8780 C Koloss extension



Application: Extension for use with Wera Koloss 8002 C to increase torque transfer

Design: Tough, tempered Cr-Mo steel

Handle: Multi-component Kraftform handle for optimum pressure, impact and tensile loads, laser-engraved safety instructions for permanent recognition



	⌀	⌀
	mm	mm
05003695001	341,0	137

8781 C Koloss centring pin



Application: Centering pin for use with Wera Koloss 8002 C to align lugs or drill holes

Design: Tapered pin out of tough, tempered Cr-Mo steel

	 mm	 mm
05003696001	50	135,0

8782 C Koloss pad set



Application: Protective attachment for striking faces for use with Wera Koloss 8002 C to protect materials and surfaces

Design: Flexible, thermoplastic elastomer material for lasting elasticity and maximum protection

	#	 mm
05003697001	2	50,0

Unlocking pin



Application: For unlocking the connection between the Koloss Ratchet 8002 C and the Koloss Extension 8780 C as well as the connection between Zyklop Hybrid Ratchet 8006 C and the Zyklop Hybrid Extension 8797 C

Design: Zinc die casting

	 mm
05136400001	40,5

Tip

Dry-fined hammer face



Dry-fined hammer face: used with rubber pad attachments to protect materials and surfaces.

Why do the dual ratchet teeth provide particular robustness?



Dual ratchet teeth: gives the robust 30 saw teeth the precision engineering effect of 60 fine teeth with a 6° return angle.

Who is the Koloss suitable for?



Basically anyone who would like to work with a 1/2" ratchet. Typical fields of application are mechanical engineering, boatbuilding, mining, aircraft construction, bridge building, commercial vehicle construction and maintenance, railway and road construction and maintenance, industrial plant and equipment construction, high-bay warehouse construction, petroleum industry and many more.

Zyklop Mini

Combines elegant design with incredible resilience. Suitable for rapid fastening even in confined working situations. The Wera Zyklop Mini is applied whenever fastening with a power tool or conventional tools is impossible due to insufficient space.

The Zyklop Mini 1 for the direct attachment of bits; the Zyklop Mini 2 for the direct attachment of the special Wera Zyklop sockets.



The fine tooth mechanism, with its 60 teeth, allows a small return angle of only 6° – ideal for precision work.

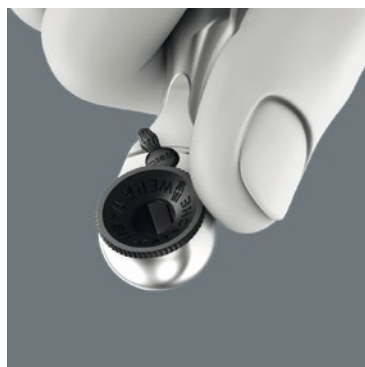

Thumbwheel enables rapid screw-driving, even when there isn't sufficient room for ratcheting use.



Simple switching between left/right operations.



Its slim design makes it ideal for all particularly confined working situations.

Zyklop Mini

For confined spaces

Bit-Check 30 Zyklop Mini 1



28 bits, 1 Rapidaptor bit holder, 1 adaptor 870/1 (1/4" hexagon to 1/4" square), 1 Wera Bit Ratchet, drop-forged full steel design, suitable for 1/4" hex bits as per DIN ISO 1173-C 6,3 and E 6,3 and Wera series 1 and 4

05073640001		
	8001 A	1 x 1/4"x87,0
⊙	870/1	1 x 1/4"x25
⊙	889/4/1 K	1 x 1/4"x50
+	851/1 TZ PH	2 x PH 1x25; 3 x PH 2x25; 1 x PH 3x25
+	855/1 TH PZ	1 x PZ 1x25; 3 x PZ 2x25; 1 x PZ 3x25
⊕	867/1 TZ TORX®	1 x TX 10x25; 1 x TX 15x25; 1 x TX 20x25; 1 x TX 25x25; 1 x TX 30x25; 1 x TX 40x25
⊕	867/1 Z TORX®	1 x TX 10x25; 1 x TX 15x25; 1 x TX 20x25; 1 x TX 25x25; 1 x TX 30x25
⊖	800/1 TZ	1 x 1,0x5,5x25
○	840/1 Z Hex-Plus	1 x 3,0x25; 1 x 4,0x25; 1 x 5,0x25; 1 x 6,0x25; 1 x 8,0x25

Bit-Check 30 Zyklop Mini 2



28 bits, 1 Rapidaptor bit holder, 1 adaptor 870/1 (1/4" hexagon to 1/4" square), 1 Wera Bit Ratchet, drop-forged full steel design, suitable for 1/4" hex bits as per DIN ISO 1173-C 6,3 and E 6,3 and Wera series 1 and 4

05346293001		
	8001 A	1 x 1/4"x87,0
⊙	870/1	1 x 1/4"x25
⊙	889/4/1 K	1 x 1/4"x50
+	851/1 TZ PH	2 x PH 1x25; 3 x PH 2x25; 1 x PH 3x25
⊕	867/1 TZ TORX®	1 x TX 10x25; 1 x TX 15x25; 1 x TX 20x25; 1 x TX 25x25; 1 x TX 30x25; 1 x TX 40x25
⊕	867/1 Z TORX®	1 x TX 10x25; 1 x TX 15x25; 1 x TX 20x25; 1 x TX 25x25; 1 x TX 30x25
⊖	800/1 TZ	1 x 1,0x5,5x25
○	840/1 Z Hex-Plus	1 x 3/32"x25; 1 x 1/8"x25; 1 x 5/32"x25; 1 x 3/16"x25; 1 x 1/4"x25
○	868/1 Z	1 x # 1x25; 3 x # 2x25; 1 x # 3x25

Kraftform Kompakt Zyklop Mini 2



1 Wera Bit Ratchet Zyklop Mini 1, drop-forged full steel design, suitable for 1/4" hex bits as per DIN ISO 1173-C 6,3 and E 6,3 and Wera series 1 and 4. Can also be used with 1/4" sockets by using the Wera socket adaptor 870/1. 1 Wera Ratchet Zyklop Mini 2, drop-forged full steel design, suitable for for Wera sockets 8790 FA. 9 Wera sockets 8790 FA, 1 socket adaptor 870/1, 14 bits, tough, for universal use

05135918001	
	8001 A 1 x 1/4"x87,0
	8005 1 x 107
	813 1 x 1/4"x78
	870/1 1 x 1/4"x25
	851/1 Z PH 1 x PH 1x25; 1 x PH 2x25
	855/1 Z PZ 1 x PZ 1x25; 1 x PZ 2x25
	867/1 TORX® 1 x TX 10x25; 1 x TX 15x25; 1 x TX 20x25; 1 x TX 25x25; 1 x TX 30x25; 1 x TX 40x25
	840/1 Z Hex-Plus 1 x 3,0x25; 1 x 4,0x25; 1 x 5,0x25; 1 x 6,0x25
	8790 FA 1 x 4,0; 1 x 5,0; 1 x 5,5; 1 x 6,0; 1 x 7,0; 1 x 8,0; 1 x 10,0; 1 x 12,0; 1 x 13,0

Tip

Zyklop Mini tool sets



Available in a set with the dependable Wera Bit-Check with socket adaptor and belt clip. Simple fitting and removal of tools. Very robust and a long service life.

Bit-Check as a lever



The Bit-Check itself can be used as a lever.

Zyklop Mini 2



The Zyklop Mini 2 is suitable for the direct attachment of the special Wera Zyklop sockets 8790 FA. These sockets feature a very low height, ideal for confined working spaces.

Zyklop Mini

For confined spaces

Tool-Check PLUS



28 bits, 1 hand holder 813 suitable for the attachment of bits with $\frac{1}{4}$ " hexagon drive as per DIN ISO 1173-C 6,3 and Wera connection series 1, 1 Rapidaptor bit holder, 1 adaptor 870/1 ($\frac{1}{4}$ " hexagon to $\frac{1}{4}$ " square), 7 sockets ($\frac{1}{4}$ "); 1 Wera Bit Ratchet, drop-forged full steel design suitable for the attachment of bits with $\frac{1}{4}$ " hexagon drive as per DIN ISO 1173-C 6,3 and E 6,3 and Wera connection series 1 and 4; the use of $\frac{1}{4}$ " sockets is also possible with the application of the Wera adaptor 870/1

05056490001		
●	8001 A	1 x 1/4"x87,0
●	813	1 x 1/4"x78
●○	889/4/1 K	1 x 1/4"x50
○	870/1	1 x 1/4"x25
●	8790 HMA	1 x 5,5x23,0; 1 x 6,0x23,0; 1 x 7,0x23,0; 1 x 8,0x23,0; 1 x 10,0x23,0; 1 x 12,0x23,0; 1 x 13,0x23,0
⊕	851/1 TZ PH	2 x PH 1x25; 3 x PH 2x25; 1 x PH 3x25
⊕	855/1 TH PZ	1 x PZ 1x25; 3 x PZ 2x25; 1 x PZ 3x25
⊕	867/1 TZ TORX®	1 x TX 10x25; 1 x TX 15x25; 1 x TX 20x25; 1 x TX 25x25; 1 x TX 30x25; 1 x TX 40x25
⊕	867/1 Z TORX®	1 x TX 10x25; 1 x TX 15x25; 1 x TX 20x25; 1 x TX 25x25; 1 x TX 30x25
○	840/1 Z Hex-Plus	1 x 3,0x25; 1 x 4,0x25; 1 x 5,0x25; 1 x 6,0x25; 1 x 8,0x25
●	800/1 TZ	1 x 1,0x5,5x25

Tool-Check PLUS Imperial



28 bits, 1 hand holder 813 suitable for the attachment of bits with $\frac{1}{4}$ " hexagon drive as per DIN ISO 1173-C 6,3 and Wera connection series 1, 1 Rapidaptor bit holder, 1 adaptor 870/1 ($\frac{1}{4}$ " hexagon to $\frac{1}{4}$ " square), 7 sockets ($\frac{1}{4}$ "); 1 Wera Bit Ratchet, drop-forged full steel design suitable for the attachment of bits with $\frac{1}{4}$ " hexagon drive as per DIN ISO 1173-C 6,3 and E 6,3 and Wera connection series 1 and 4; the use of $\frac{1}{4}$ " sockets is also possible with the application of the Wera adaptor 870/1

05056491001		
●	8001 A	1 x 1/4"x87,0
●	813	1 x 1/4"x78
●○	889/4/1 K	1 x 1/4"x50
○	870/1	1 x 1/4"x25
●	8790 HMA	1 x 3/16"x23,0; 1 x 1/4"x23,0; 1 x 5/16"x23,0; 1 x 11/32"x23,0; 1 x 3/8"x23,0; 1 x 7/16"x23,0; 1 x 1/2"x23,0
⊕	851/1 TZ PH	2 x PH 1x25; 3 x PH 2x25; 1 x PH 3x25
●	800/1 TZ	1 x 1,0x5,5x25
⊕	867/1 TZ TORX®	1 x TX 10x25; 1 x TX 15x25; 1 x TX 20x25; 1 x TX 25x25; 1 x TX 30x25; 1 x TX 40x25
⊕	867/1 Z TORX®	1 x TX 10x25; 1 x TX 15x25; 1 x TX 20x25; 1 x TX 25x25; 1 x TX 30x25
○	840/1 Z Hex-Plus	1 x 3/32"x25; 1 x 1/8"x25; 1 x 5/32"x25; 1 x 3/16"x25; 1 x 5/16"x25
○	868/1 V	1 x # 1x25; 3 x # 2x25; 1 x # 3x25



”To learn more about this product, scan the QR code.“

Tool-Check 1 SB



28 bits; 1 socket adaptor 870/1 (1/4" hexagonal to 1/4" square); 7 manual & power tool sockets; 1 Rapidaptor bit holder; 1 Wera Bit Ratchet, with drop-forged steel design suitable for the fitting of bits with 1/4" hexagonal headed drive as per DIN ISO 1173-C 6,3 and E 6,3, i.e. Wera Series 1 and 4. Can also be used with 1/4" sockets by using the socket adaptor (870/1).

05073220001	
8001 A	1 x 1/4"x87,0
870/1	1 x 1/4"x25
889/4/1 K	1 x 1/4"x50
851/1 TZ PH	2 x PH 1x25; 3 x PH 2x25; 1 x PH 3x25
855/1 TH PZ	1 x PZ 1x25; 3 x PZ 2x25; 1 x PZ 3x25
867/1 TZ	1 x TX 10x25; 1 x TX 15x25; 1 x TX 20x25;
TORX®	1 x TX 25x25; 1 x TX 30x25; 1 x TX 40x25
867/1 Z TORX®	1 x TX 10x25; 1 x TX 15x25; 1 x TX 20x25;
B0	1 x TX 25x25; 1 x TX 30x25
800/1 TZ	1 x 1,0x5,5x25
840/1 Z	1 x 3,0x25; 1 x 4,0x25; 1 x 5,0x25; 1 x 6,0x25;
Hex-Plus	1 x 8,0x25
8790 HMA	1 x 5,5x23,0; 1 x 6,0x23,0; 1 x 7,0x23,0;
	1 x 8,0x23,0; 1 x 10,0x23,0; 1 x 12,0x23,0;
	1 x 13,0x23,0

Tip

What parts can be connected to the Zyklop Mini 1?

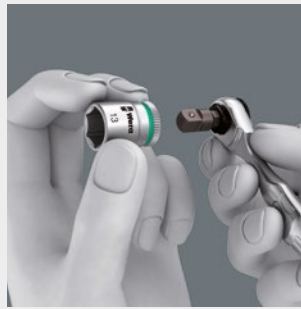

Bits and sockets. Bits can be connected directly. However, a holder can be connected first and then the bit can be attached to this. This then serves as an extension with a free-turning sleeve. An adaptor e.g. Wera 870/1 is needed for sockets – 1/4" hexagonal on a square drive (included in the Bit-Check and with the individual Zyklop Mini 1 in the set).

When is the Zyklop Mini 1 needed?

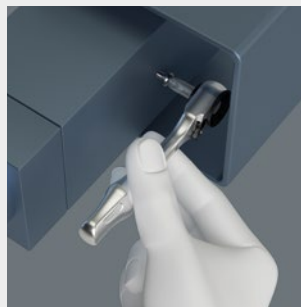

Particularly when the space is confined and there is not much room for the tool.

Is rapid screwdriving possible with the Zyklop Mini?



High working speeds can be attained with the Zyklop Mini. The thumb wheel is important, enabling more rapid screwdriving, and the Zyklop Mini handle only needs to be used for the final tightening of the screw.



"Take it easy"



"Take it easy" tool finder system – with profile and size colour-coding for quick and easy tool selection. Colour-coded system for hexagon drive screws (L-Keys, Zyklop bit sockets), external hex drive screws and nuts (Joker wrenches, Zyklop sockets and Zyklop bit sockets with holding function), and TORX® drive screws (L-Keys, Zyklop bit sockets).

Zyklop Mini

For confined spaces

Tool-Check Automotive 1



28 bits; 1 870/1 socket adaptor (1/4" hexagonal to 1/4" square); 7 manual & power tool sockets; 1 Rapidaptor bit holder; 1 Wera Bit Ratchet, with drop-forged steel design suitable for the fitting of bits with 1/4" hexagonal headed drive as per DIN ISO 1173-C 6,3 and E 6,3, i.e. Wera Series 1 and 4. Can also be used with 1/4" sockets by using the socket adaptor (870/1).

05200995001	
8001 A	1 x 1/4"x87,0
870/1	1 x 1/4"x25
889/4/1 K	1 x 1/4"x50
851/1 TZ PH	1 x PH 1x25; 1 x PH 2x25; 1 x PH 3x25
867/1 TZ TORX®	1 x TX 10x25; 1 x TX 15x25; 1 x TX 20x25; 1 x TX 25x25; 1 x TX 30x25; 1 x TX 40x25
867/1 Z TORX® B0	1 x TX 10x25; 1 x TX 15x25; 1 x TX 20x25; 1 x TX 25x25; 1 x TX 30x25
800/1 TZ	1 x 1,0x5,5x25
840/1 Z Hex-Plus	1 x 3,0x25; 1 x 4,0x25; 1 x 5,0x25; 1 x 6,0x25; 1 x 8,0x25
860/1 XZN Vielzahn	1 x M 4x25; 1 x M 5x25; 1 x M 6x25; 1 x M 8x25
873/1 Five Lobe	1 x 20x25; 1 x 25x25; 1 x 27x25; 1 x 30x25
8790 HMA	1 x 5,5x23,0; 1 x 6,0x23,0; 1 x 7,0x23,0; 1 x 8,0x23,0; 1 x 10,0x23,0; 1 x 12,0x23,0; 1 x 13,0x23,0

Bit-Check 10 Zyklop Mini 1

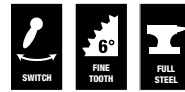

9 bits, tough, for universal use, 1 Wera Bit Ratchet Zyklop Mini 1, drop-forged full steel design, suitable for 1/4" hex bits as per DIN ISO 1173-C 6.3 and E 6.3 and Wera series 1 and 4. Can also be used with 1/4" sockets by using the Wera socket adaptor 870/1.

05073645001	
8001 A	1 x 1/4"x87,0
851/1 Z PH	1 x PH 1x25; 1 x PH 2x25
855/1 Z PZ	1 x PZ 1x25; 1 x PZ 2x25
867/1 TORX®	1 x TX 15x25; 1 x TX 20x25; 1 x TX 25x25
840/1 Z Hex-Plus	1 x 4,0x25; 1 x 5,0x25

Bit-Check 10 Zyklop Mini BiTorsion 1



9 bits, BiTorsion for long service life, extra-tough, for universal use. Take it easy toolfinder: Output colour coding (red = Phillips; black = Pozidriv; green = TORX®; blue = hexagon) and large stamp to enable the desired bit to be easily located. , 1 Wera Bit Ratchet Zyklop Mini 1, drop-forged full steel design, suitable for 1/4" hex bits as per DIN ISO 1173-C 6.3 and E 6.3 and Wera series 1 and 4. Can also be used with 1/4" sockets by using the Wera socket adaptor 870/1.

05057418001	
8001 A	1 x 1/4"x87,0
851/1 BTZ PH	1 x PH 1x25; 1 x PH 2x25
855/1 BTZ PZ	1 x PZ 1x25; 1 x PZ 2x25
867/1 TORX® BTZ	1 x TX 15x25; 1 x TX 20x25; 1 x TX 25x25
840/1 BTZ Hex-Plus	1 x 4,0x25; 1 x 5,0x25



Zyklop Mini

For confined spaces

8001 A Zyklop Mini 1 Bit Ratchet 1/4" SB with 1/4" drive



Application: Suitable for 1/4" hex bits as per DIN ISO 1173-C 6,3 and E 6,3 and Wera series 1 and 4, Wera adaptor 870/1 for 1/4" sockets

Design: Drop-forged full steel design, fine-tooth ratchet mechanism, small return angle of 6°, forward and reverse drive switch

Handle: Kraftform handle with proven Kraftform geometry provides perfectly designed finger contact zones, ergonomic ratchet head and handle

05073230001		
	8001 A	1 x 1/4"x87,0
	870/1	1 x 1/4"x25

Zyklop Mini 2



Application: Suitable for Wera sockets 8790 FA

Design: Drop-forged full steel design, fine-tooth ratchet mechanism, small return angle of 6°, forward and reverse drive switch

Handle: Kraftform handle with proven Kraftform geometry provides perfectly designed finger contact zones, ergonomic ratchet head and handle





		mm
05003660001		107



8790 FA Zyklop socket with 1/4" and Hexagon 11 drive



- Application:** Hexagon headed bolts, screws and nuts
Design: 1/4" external square and hexagon size; suitable for 1/4" ratchets and Wera Zyklop Mini 2 ratchet
Handle: Manual applications; ball intercept ring; extremely low height, ideal for confined spaces; chrome vanadium, chrome-plated

	 mm	 mm	 mm	 mm	 mm
05003665001	4,0	11,8	9,5	18,0	6,4
05003666001	4,5	11,8	9,5	18,0	7,0
05003667001	5,0	11,8	9,5	18,0	7,6
05003668001	5,5	11,8	9,5	18,0	8,2
05003669001	6,0	11,8	9,5	18,0	9,2
05003670001	7,0	11,8	9,5	18,0	10,4
05003675001	8,0	11,8	9,5	18,0	11,5
05003690001	10,0	11,8	9,5	18,0	13,8
05003684001	12,0	11,8	9,5	18,0	16,8
05003685001	13,0	11,8	9,5	18,0	17,8



” To learn more about this product, scan the QR code. “

Tip

Is such a small tool sufficiently resilient?



The Zyklop Mini 1 can withstand at least 65 Nm. That is far more power than can normally be transferred to such a small tool.

Zyklop Mini 2



The Zyklop Mini 2 is suitable for the direct attachment of the special Wera Zyklop sockets 8790 FA. These sockets feature a very low height, ideal for confined working spaces.



“Take it easy”



“Take it easy” tool finder system – with profile and size colour-coding for quick and easy tool selection. Colour-coded system for hexagon drive screws (L-Keys, Zyklop bit sockets), external hex drive screws and nuts (Joker wrenches, Zyklop sockets and Zyklop bit sockets with holding function), and TORX® drive screws (L-Keys, Zyklop bit sockets).



Joker Wrenches



Joker
Ratcheting combination wrenches

228



Joker Switch
Ratcheting combination wrenches

230



Joker open-ended wrenches

When we began to think about open-ended wrenches, we asked ourselves: why does the wrench always have to be flipped over; why does it have an offset design; why does it slip off injuring fingers? The new design of the mouth resulted in a real “Joker” that works even when all other trumps have been played.



The Joker's holding function means that nuts and bolts can be held in the jaw and easily positioned where they are needed. Fastening on to the thread can then be done quickly and safely, thanks to the innovative special stop-plate which holds the fastener. No more time-wasting searches for dropped nuts and bolts! After applying and positioning the nut or bolt, fastening can begin immediately – no additional tools required.



Constant re-positioning of the wrench? Difficulty holding fasteners in confined spaces? Easing off to avoid any risks of injury or fastener damage? That was yesterday. Today, the Joker prevents slipping off of the fastener head with its integrated limit-stop – no longer is the thumb needed to act as a depth stop. This makes applications much easier and allows significantly more force to be applied during fastening jobs.



The Joker's clever double-hex geometry delivers a very positive connection with nuts or bolts – it's a perfect fit. And the exchangeable, hardened metal gripping plate in the Joker's mouth literally bites itself into the bolt, with its extremely hard tips. Both features combine to prevent slipping, even at higher torque.



Instead of 60°, the Joker only has a 30° return angle thanks to its unique double-hex design. Along with the Joker's straight neck, this means that flipping the wrench has become a thing of the past. With the Joker, you can now loosen and tighten nuts and bolts, in situations where conventional tools fail. Particularly in confined spaces, where conventional open-jawed wrenches cannot be used. The combination of limit stop and small return angle enables effective work, even on screw pipe connections.



The ratcheting feature at the ring end boasts an exceptional, fine tooth mechanism – 80 teeth in all – which provides greater flexibility, even in very confined workspaces.

Joker

Combination ratchet wrenches

Joker Ratcheting combination wrenches



Application: Hexagonal nuts or bolts

Design: Ratcheting combination wrench

		mm	mm	mm	mm	mm	mm
05073268001		8	144	20	5,5	18	7
05073270001		10	159	22	5,5	21	7,2
05073271001		11	165	25	6,3	22	7,5
05073272001		12	170,7	26,3	6,6	25	8,5
05073273001		13	177	27,3	7	25	8,6
05073274001		14	188	29,3	7,5	28	9,2
05073275001		15	200	32,3	7,8	28,5	9,2
05073276001		16	212	35	8,2	32,7	10,5
05073277001		17	224	37,2	8,5	32,7	10,5
05073278001		18	235	39	9	33,8	11
05073279001		19	246	42	9,5	34,8	11

Joker Ratcheting combination wrenches, imperial

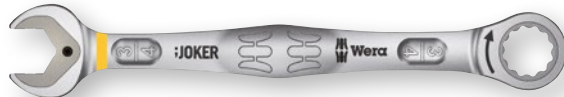

Application: Hexagonal nuts or bolts

Design: Ratcheting combination wrench

		mm	mm	mm	mm	mm	mm
05073280001		5/16"	144	20	5,5	18	7
05073281001		3/8"	159	22	5,5	21	7,2
05073282001		7/16"	165	25	6,3	22	7,5
05073283001		1/2"	177	27,3	7	25	8,6
05073284001		9/16"	188	29,3	7,5	28	9,2
05073285001		5/8"	212	35	8,2	32,7	10,5
05073286001		11/16"	235	39	9	33,8	11
05073287001		3/4"	246	42	9,5	34,8	11

Joker Double open-ended wrenches

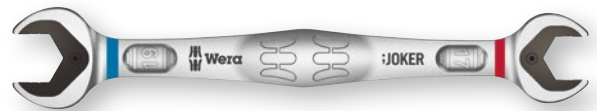

Application: Hexagon bolts and nuts

Design: Double open-ended wrench

		mm	mm	mm	mm	mm	mm
05003760001		10	23	13	27	5,5	7
05003765001		17	37	19	42	8,5	9,5

Joker Set of Ratcheting combination wrenches



Set of ratcheting combination wrenches

11-piece set

Durable pouch

		mm	mm	mm	mm	mm	mm
05020013001	Joker	1 x 8x144; 1 x 10x159; 1 x 11x165; 1 x 12x170,7; 1 x 13x177; 1 x 14x188; 1 x 15x200; 1 x 16x212; 1 x 17x224; 1 x 18x235; 1 x 19x246					

Joker Set of Ratcheting combination wrenches, imperial



Set of ratcheting combination wrenches
8-piece set
Durable pouch

05020012001	
Joker inch	1 x 5/16"x144; 1 x 3/8"x159; 1 x 7/16"x165; 1 x 1/2"x177; 1 x 9/16"x188; 1 x 5/8"x212; 1 x 11/16"x235; 1 x 3/4"x246

Joker Set of Ratcheting combination / double open-ended wrenches



Ratcheting Combination/Double Open-Ended Wrench Set
6-piece set
Durable pouch

05020022001	
Joker	1 x 10x159; 1 x 13x177; 1 x 17x224; 1 x 19x246
Joker Double	1 x 10x13x167; 1 x 17x19x235

Tip

Fine tooth mechanism



The ratcheting feature at the ring end boasts an exceptional, fine tooth mechanism – 80 teeth in all – which provides greater flexibility, even in very confined working spaces.

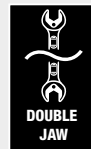

Double open-ended wrench



The Joker double open-ended wrench is ideally suited for locking down nuts and bolts.



“Take it easy”



“Take it easy” tool finder system – with profile and size colour-coding for quick and easy tool selection. Colour-coded system for hexagon drive screws (L-Keys, Zyklop bit sockets), external hex drive screws and nuts (Joker wrenches, Zyklop sockets and Zyklop bit sockets with holding function), and TORX® drive screws (L-Keys, Zyklop bit sockets).

Joker

Combination ratchet wrenches

Joker Set of Ratcheting combination wrenches



Set of ratcheting combination wrenches
4-piece set
Durable pouch

05073290001	Joker	1 x 10x159; 1 x 13x177; 1 x 17x224; 1 x 19x246
-------------	-------	---

Joker Set of Ratcheting combination wrenches, imperial



Set of ratcheting combination wrenches
4-piece set
Durable pouch

05073295001	Joker inch	1 x 7/16"x165; 1 x 1/2"x177; 1 x 9/16"x188; 1 x 3/4"x246
-------------	------------	---



” To learn more about this product, scan the QR code. “

Joker Switch Ratcheting combination wrenches, with switch lever



Application: Hexagonal nuts or bolts

Design: Ratcheting combination wrench, switch lever for convenient change of direction; ring end angled at 15° from the handle

		mm	mm	mm	mm	mm	mm
05020064001		8	144	20,3	5,5	18	7
05020065001		10	159	23	5,5	21,5	7,5
05020066001		11	165	24,3	6,3	22	7,5
05020067001		12	171	26,3	6,6	25	8,5
05020068001		13	179	27,3	7	26	8,5
05020069001		14	187	30	7,5	28	9,5
05020070001		15	199	32	7,8	28,8	9,5
05020071001		16	213	35	8,2	31,7	10,5
05020072001		17	225	37	8,5	33	10,5
05020073001		18	234	39,5	9	34	11
05020074001		19	246	42	9,5	34,7	11

Joker Switch Ratcheting combination wrenches, Imperial, with switch lever



Application: Hexagonal nuts or bolts

Design: Ratcheting combination wrench, switch lever for convenient change of direction; ring end angled at 15° from the handle

		mm	mm	mm	mm	mm	mm
05020075001		5/16"	144	20,3	5,5	18	7
05020076001		3/8"	159	23	5,5	21,5	7,5
05020077001		7/16"	165	24,3	6,3	22	7,5
05020078001		1/2"	171	26,3	6,6	25	8,5
05020079001		9/16"	187	30	7,5	28	9,5
05020080001		5/8"	213	35	8,2	31,7	10,5
05020081001		11/16"	234	39,5	9	34	11
05020082001		3/4"	246	42	9,5	34,7	11

Joker Switch Set of Ratcheting combination wrenches

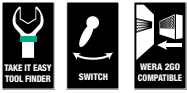

Set of ratcheting combination wrenches, reversible
 4-piece set
 Durable pouch

05020090001	
	Joker Switch 1 x 10x159; 1 x 13x179; 1 x 17x225; 1 x 19x246

Joker Switch Set of Ratcheting combination wrenches, imperial

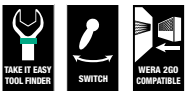

Set of ratcheting combination wrenches, reversible
 4-piece set
 Durable pouch

05020092001	
	Joker Switch 1 x 7/16"x165; 1 x 1/2"x171; 1 x 9/16"x187; inch 1 x 3/4"x246

Tip

Fine tooth mechanism



The ratcheting feature at the ring end boasts an exceptional, fine tooth mechanism – 80 teeth in all – which provides greater flexibility, even in very confined working spaces.

Angled ratchet end

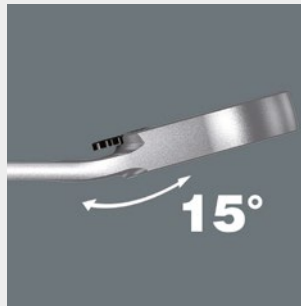

The ratchet end is angled at 15° to the tool axis, making application of the tool in confined spaces much easier.

Joker Switch



The direction of the fine-tooth ratchet mechanism can easily be changed via the smooth switch lever.



Joker

Combination ratchet wrenches

Joker Switch Set of Ratcheting combination wrenches, Imperial

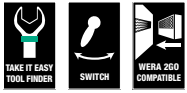

Set of ratcheting combination wrenches, reversible
 8-piece set
 Durable pouch

05020093001	
Joker Switch	1 x 5/16"x144; 1 x 3/8"x159; 1 x 7/16"x165; 1 x 1/2"x171; 1 x 9/16"x187; 1 x 5/8"x213; 1 x 11/16"x234; 1 x 3/4"x246

Joker Switch Set of Ratcheting combination wrenches

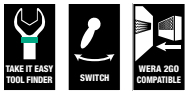

Set of ratcheting combination wrenches, reversible
 11-piece set
 Durable pouch

05020091001	
Joker Switch	1 x 8x144; 1 x 10x159; 1 x 11x165; 1 x 12x171; 1 x 13x179; 1 x 14x187; 1 x 15x199; 1 x 16x213; 1 x 17x225; 1 x 18x234; 1 x 19x246

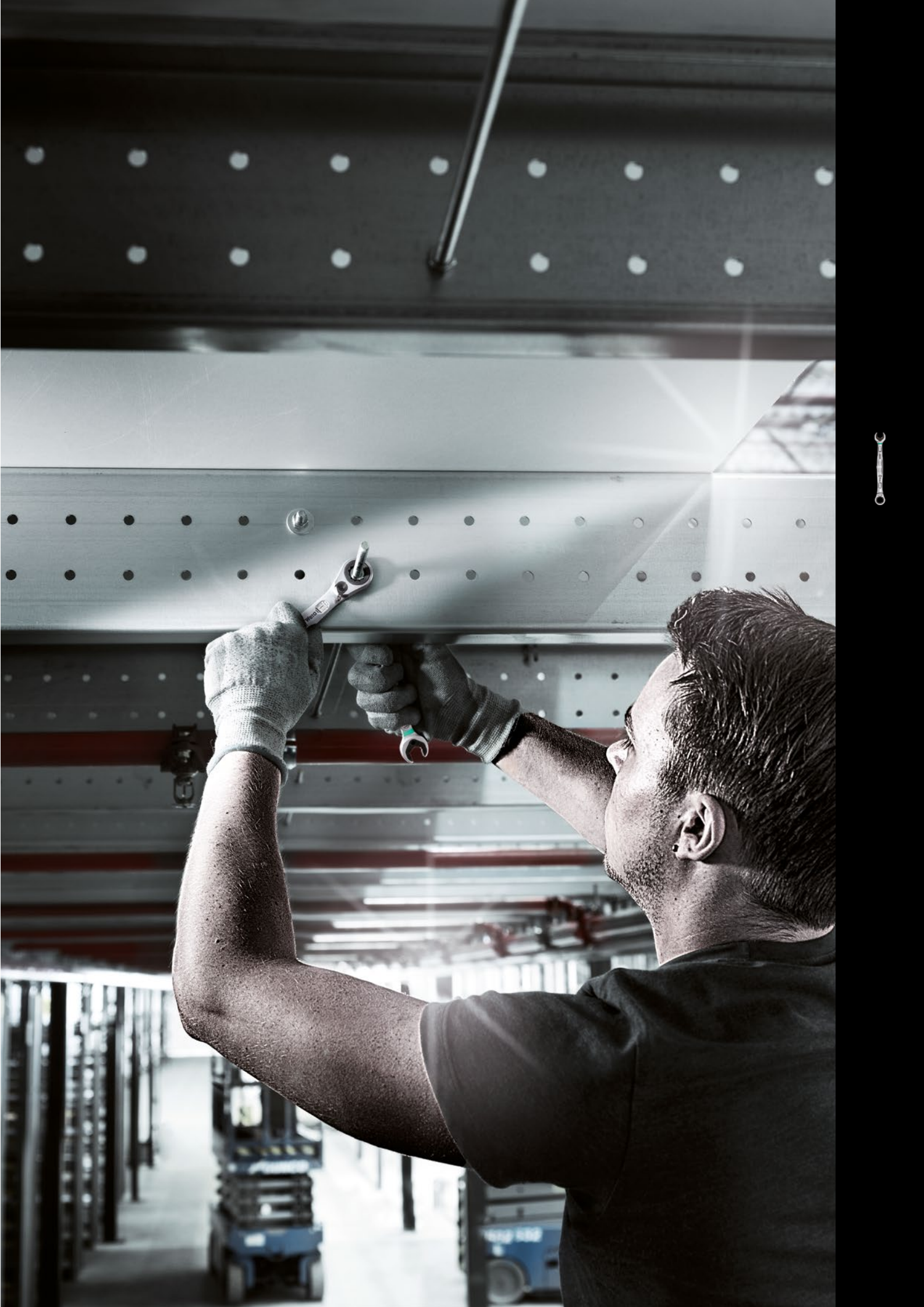



L-Keys



L-Keys for Hexagon Socket Screws

238



L-Keys for TORX® Screws

250



Offset Screwdrivers

257



L-Keys

We questioned the classic L-key design, since all too often the screw head recess is rounded out, meaning screws can no longer be tightened or loosened – and so the user finds the L-key slipping out of the recess.

Wera Hex-Plus tools have a larger contact surface in the screw head. The notching effects are reduced and thereby the deformation of the screws. At the same time, as much as 20 % more torque can be applied.

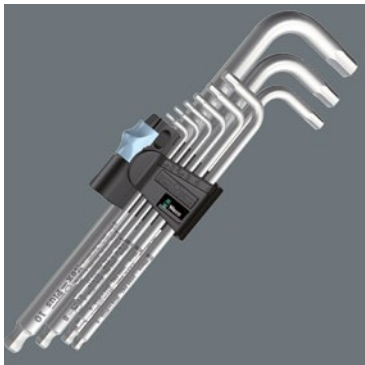

Stainless L-keys are hardened to the same strength as conventional (carbon) steel tools, and prevent extraenous rust forming.



SPKL – protects fingers! L-keys with a thermoplastic sleeve (SPKL) are manufactured out of easy-to-grip, circular material. The sleeve ensures that work is safe and comfortable even at low temperatures. High corrosion protection features thanks to the special BlackLaser surface treatment. Colour coding and large stamp to enable the desired L-key to be easily located.



Chrome-plated hexagon L-keys or with BlackLaser surface treatment for outstanding surface protection and long service life. High corrosion protection.



The size of each L-keys has been engraved by a laser. In addition SPKL L-keys have a colour coding according to sizes – for simple and rapid accessing of the required tool. Making it easy to find the right tool.



The wear-resistant clip material ensures that the L-keys are securely held yet are easy to remove.

L-Keys for Hexagon Socket Screws

The Hex-Plus profile extends the service life of hexagon socket screws

3950/9 Hex-Plus Multicolour Stainless 1 L-key set, metric, stainless

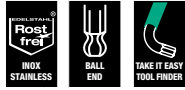

9-piece set in a two-component clip

Application: Hexagon socket screws

Design: Stainless steel, durable plastic sleeve. The contrasting inscriptions on the colour-coded sleeves mean that it is easy to recognise the correct sizes and this makes it simpler to find the right tool.

Tip: Hex-Plus, ball-end hexagon on long arm

05022669001	
○	3950 SPKL Multicolour 1 x 1,5x90; 1 x 2,0x101; 1 x 2,5x112; 1 x 3,0x123; 1 x 4,0x137; 1 x 5,0x154; 1 x 6,0x172; 1 x 8,0x195; 1 x 10,0x224

3950/9 Hex-Plus Stainless 1 L-key set, metric, stainless



9-piece set in a two-component clip

Application: Hexagon socket screws

Design: Stainless steel

Tip: Hex-Plus, ball-end hexagon on long arm

05022720001	
○	3950 PKL 1 x 1,5x90; 1 x 2,0x101; 1 x 2,5x112; 1 x 3,0x123; 1 x 4,0x137; 1 x 5,0x154; 1 x 6,0x172; 1 x 8,0x195; 1 x 10,0x224

3950/9 Hex-Plus Stainless 1 SB L-key set, metric, stainless



05073544001

4013288 180377

○ **3950 PKL**
1 x 1.5x90; 1 x 2.0x101;
1 x 2.5x112;
1 x 3.0x123;
1 x 4.0x137;
1 x 5.0x154;
1 x 6.0x172;
1 x 8.0x195;
1 x 10.0x224

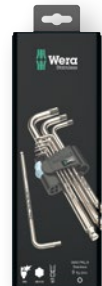

3950/9 Hex-Plus Imperial Stainless 1 L-key set, imperial, stainless



9-piece set in belt pouch

Application: Hexagon socket screws

Design: Stainless steel

Tip: Hex-Plus, ball-end hexagon on long arm

05022721001	
○	3950 PKL inch 1 x 3/32"x112; 1 x 7/64"x119; 1 x 1/8"x123; 1 x 9/64"x130; 1 x 5/32"x137; 1 x 3/16"x154; 1 x 1/4"x185; 1 x 5/16"x195; 1 x 3/8"x224

Tip



“Take it easy”



“Take it easy” tool finder system – with profile and size colour-coding for quick and easy tool selection. Colour-coded system for hexagon drive screws (L-Keys, Zyklop bit sockets), external hex drive screws and nuts (Joker wrenches, Zyklop sockets and Zyklop bit sockets with holding function), and TORX® drive screws (L-Keys, Zyklop bit sockets).

Why do the SPKL L-keys from Wera have a round design and come with a rubber sleeve?



L-keys made from circular material fit into the hand better and allow less strenuous work over a longer period. Additionally, the rubber sleeve provides a pleasant grip, particularly in applications at low temperatures. Colour coding and large stamp enable the desired L-key to be easily located. Moreover, the round material keys are more robust, particularly where smaller sizes are concerned.



TORX® and hexagon ball tip



The spherical drive profile means that it is possible to swivel the axis of the tool to that of the screw, and therefore enable angled, “around-the-corner” screwdriving jobs. This ball tip geometry – often found on L-keys – is now available on a number of Wera bits.



L-Keys for Hexagon Socket Screws

The Hex-Plus profile extends the service life of hexagon socket screws

950/9 Hex-Plus Multicolour HF 1 L-key set, metric, BlackLaser, with holding function

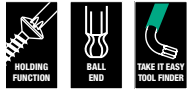



9-piece set in a two-component clip

Application: Hexagon socket screws

Design: BlackLaser surface, durable plastic sleeve. The contrasting inscriptions on the colour-coded sleeves mean that it is easy to recognise the correct sizes and this makes it simpler to find the right tool.

Tip: Hex-Plus, ball-end hexagon on long arm, holding function for hexagon socket screws, sizes: 1.5, 2.0 and 2.5 without holding function

	
05022210001	
	950 SPKL Multicolour 1 x 1,5x90; 1 x 2,0x101; 1 x 2,5x112
	950 SPKL HF Multicolour 1 x 3,0x123; 1 x 4,0x137; 1 x 5,0x154; 1 x 6,0x172; 1 x 8,0x195; 1 x 10,0x224

950/9 Hex-Plus Multicolour 1 L-key set, metric, BlackLaser



9-piece set in a two-component clip



Application: Hexagon socket screws

Design: BlackLaser surface, durable plastic sleeve. The contrasting inscriptions on the colour-coded sleeves mean that it is easy to recognise the correct sizes and this makes it simpler to find the right tool.

Tip: Hex-Plus, ball-end hexagon on long arm

05022089001	
	950 SPKL Multicolour 1 x 1,5x90; 1 x 2,0x101; 1 x 2,5x112; 1 x 3,0x123; 1 x 4,0x137; 1 x 5,0x154; 1 x 6,0x172; 1 x 8,0x195; 1 x 10,0x224

950/9 Hex-Plus Multicolour 1 SB L-key set, metric, BlackLaser

	
05073593001	 4013288 165688
	950 SPKL Multicolour 1 x 1.5x90; 1 x 2.0x101; 1 x 2.5x112; 1 x 3.0x123; 1 x 4.0x137; 1 x 5.0x154; 1 x 6.0x172; 1 x 8.0x195; 1 x 10.0x224



950/9 Hex-Plus Multicolour Imperial 1 L-key set, imperial, BlackLaser



9-piece set in belt pouch

Application: Hexagon socket screws

Design: BlackLaser surface, durable plastic sleeve. The contrasting inscriptions on the colour-coded sleeves mean that it is easy to recognise the correct sizes and this makes it simpler to find the right tool.

Tip: Hex-Plus, ball-end hexagon on long arm

05022639001	
○	950 SPKL inch 1 x 5/64"x101; 1 x 3/32"x112; 1 x 1/8"x123; 1 x 5/32"x137; 1 x 3/16"x154; 1 x 7/32"x172; 1 x 1/4"x185; 1 x 5/16"x195; 1 x 3/8"x224

950/7 Hex-Plus Multicolour Magnet 1 L-key set, metric, BlackLaser



7-piece set in a two-component clip. For recessed screws, it's often advantageous for the screw to be held on the L-key by magnetic force. The Wera clips with magnetiser/demagnetiser enable a magnetisation/demagnetisation of L-keys in a flash.

Application: Hexagon socket screws

Design: BlackLaser surface, durable plastic sleeve. The contrasting inscriptions on the colour-coded sleeves mean that it is easy to recognise the correct sizes and this makes it simpler to find the right tool.

Tip: Hex-Plus, ball-end hexagon on long arm

05022534001	
○	950 SPKL 1 x 1,5x90; 1 x 2,0x101; 1 x 2,5x112; 1 x 3,0x123; 1 x 4,0x137; 1 x 5,0x154; 1 x 6,0x172

Tip



“Take it easy”



“Take it easy” tool finder system – with profile and size colour-coding for quick and easy tool selection. Colour-coded system for hexagon drive screws (L-Keys, Zyklop bit sockets), external hex drive screws and nuts (Joker wrenches, Zyklop sockets and Zyklop bit sockets with holding function), and TORX® drive screws (L-Keys, Zyklop bit sockets).



Holding function on long arm



The clamping of the screw is achieved by a flexible locking ball. The holding function is especially helpful in confined, hard-to-reach spaces, where there is no room for a second hand to secure the screw.



Magnetiser/Demagnetiser



Magnetising

For recessed screws, it's often advantageous for the screw to be held on the L-key by magnetic force. The Wera clips with magnetiser/demagnetiser enable a magnetisation/demagnetisation of L-keys in a flash.



Demagnetising



L-Keys for Hexagon Socket Screws

The Hex-Plus profile extends the service life of hexagon socket screws

950/9 Hex-Plus 1 L-key set, metric, chrome-plated



9-piece set in a two-component clip

Application: Hexagon socket screws

Design: Chrome-plated

Tip: Hex-Plus, ball-end hexagon on long arm

05022087001	
○	950 PKL 1 x 1,5x90 ¹⁾ ; 1 x 2,0x100; 1 x 2,5x112; 1 x 3,0x126; 1 x 4,0x140; 1 x 5,0x160; 1 x 6,0x180; 1 x 8,0x200; 1 x 10,0x219

¹⁾ Regular hexagon

950/9 Hex-Plus 2 L-key set, metric, chrome-plated



9-piece set in a two-component clip

Application: Hexagon socket screws



Design: Chrome-plated

Tip: Hex-Plus

05021909001	
○	950 L 1 x 1,5x90 ¹⁾ ; 1 x 2,0x100; 1 x 2,5x112; 1 x 3,0x126; 1 x 4,0x140; 1 x 5,0x160; 1 x 6,0x180; 1 x 8,0x200; 1 x 10,0x219

¹⁾ Regular hexagon

950/9 Hex-Plus 1 SB L-key set, metric, chrome-plated

		
		4013288
05073391001		030160
○	950 PKL 1 x 1.5x90 ¹⁾ ; 1 x 2.0x100; 1 x 2.5x112; 1 x 3.0x126; 1 x 4.0x140; 1 x 5.0x160; 1 x 6.0x180; 1 x 8.0x200; 1 x 10.0x219	

¹⁾ Regular hexagon



9-piece set in a two-component clip

Application: Hexagon socket screws

Design: Chrome-plated

Tip: Hex-Plus, ball-end hexagon on long arm

05133163001	
○	950 PKS 1 x 1,5x50 ¹⁾ ; 1 x 2,0x56; 1 x 2,5x63; 1 x 3,0x71; 1 x 4,0x80; 1 x 5,0x90; 1 x 6,0x100; 1 x 8,0x112; 1 x 10,0x125

¹⁾ Regular hexagon

950/9 Hex-Plus 4 L-key set, metric, chrome-plated

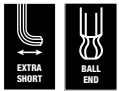



9-piece set in a two-component clip

Application: Hexagon socket screws

Blade: Chrome plated, with extra short arm for use on screws that are difficult to access

Tip: Hex-Plus, ballpoint hexagon on long arm

	
05073594001	
	950 PKLS 1 x 1,5x90 ¹⁾ ; 1 x 2,0x100; 1 x 2,5x112; 1 x 3,0x126; 1 x 4,0x140; 1 x 5,0x160; 1 x 6,0x180; 1 x 8,0x200; 1 x 10,0x219

¹⁾ Regular hexagon

950/9 Hex-Plus 5 L-key set, metric, chrome-plated



9-piece set in a two-component clip

Application: Hexagon socket screws

Design: Chrome-plated

Tip: Hex-Plus

05021406001	
	950 1 x 1,5x45 ¹⁾ ; 1 x 2,0x50; 1 x 2,5x56; 1 x 3,0x63; 1 x 4,0x70; 1 x 5,0x80; 1 x 6,0x90; 1 x 8,0x100; 1 x 10,0x112

¹⁾ Regular hexagon.

Tip



Hex-Plus for hexagon socket screws



Hexagon screws can endure a problem because the contact surfaces delivering the power from the conventional tool, is transferred to the screw via very small surface areas. The consequence: the screw can become damaged (rounding out). Hex-Plus tools have a greater contact surface that prevents this from happening! At the same time, as

much as 20 % more torque can be applied. Good to know: Hex-Plus tools fit into every standard hexagon socket screw!



Ball tip



The spherical drive profile means that it is possible to swivel the axis of the tool to that of the screw, and therefore enable angled, "around-the-corner" screwdriving jobs.



L-Keys for Hexagon Socket Screws

The Hex-Plus profile extends the service life of hexagon socket screws

950/9 Hex-Plus 6 L-key set, metric, BlackLaser



9-piece set in a two-component clip

Application: Hexagon socket screws

Design: BlackLaser surface

Tip: Hex-Plus, ball-end hexagon on long arm

05022086001	
○	950 PKL BM 1 x 1,5x90 ¹⁾ ; 1 x 2,0x100; 1 x 2,5x112; 1 x 3,0x126; 1 x 4,0x140; 1 x 5,0x160; 1 x 6,0x180; 1 x 8,0x200; 1 x 10,0x219

¹⁾ Regular hexagon

950/9 Hex-Plus 6 SB L-key set, metric, BlackLaser

			4013288
05073596001			106414
○	950 PKL BM	1 x 1.5x90 ¹⁾ ; 1 x 2.0x100; 1 x 2.5x112; 1 x 3.0x126; 1 x 4.0x140; 1 x 5.0x160; 1 x 6.0x180; 1 x 8.0x200; 1 x 10.0x219	

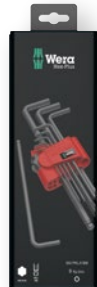

¹⁾ Regular hexagon

950/9 Hex-Plus 7 L-key set, metric, BlackLaser



9-piece set in a two-component clip

Application: Hexagon socket screws

Design: BlackLaser surface

Tip: Hex-Plus

05021737001	
○	950 BM 1 x 1,5x45 ¹⁾ ; 1 x 2,0x50; 1 x 2,5x56; 1 x 3,0x63; 1 x 4,0x70; 1 x 5,0x80; 1 x 6,0x90; 1 x 8,0x100; 1 x 10,0x112

¹⁾ Regular hexagon.

950/7 Hex-Plus Magnet 1 L-key set, metric, chrome-plated



7-piece set in a two-component clip. For recessed screws, it's often advantageous for the screw to be held on the L-key by magnetic force. The Wera clips with magnetiser/demagnetiser enable a magnetisation/demagnetisation of L-keys in a flash.

Application: Hexagon socket screws

Design: Chrome-plated

Tip: Hex-Plus, ball-end hexagon on long arm

05022101001	
○	950 PKL 1 x 1,5x90 ¹⁾ ; 1 x 2,0x100; 1 x 2,5x112; 1 x 3,0x126; 1 x 4,0x140; 1 x 5,0x160; 1 x 6,0x180

¹⁾ Regular hexagon

950/7 Hex-Plus 1 L-key set, metric, chrome-plated



7-piece set in a two-component clip

Application: Hexagon socket screws

Design: Chrome-plated

Tip: Hex-Plus, ball-end hexagon on long arm

05022181001	
○	950 PKL 1 x 1,5x90 ¹⁾ ; 1 x 2,0x100; 1 x 2,5x112; 1 x 3,0x126; 1 x 4,0x140; 1 x 5,0x160; 1 x 6,0x180

¹⁾ Regular hexagon

950/13 Hex-Plus Imperial 1 L-key set, imperial, BlackLaser



13-piece set in a two-component clip

Application: Hexagon socket screws

Design: BlackLaser surface

Tip: Hex-Plus, ball-end hexagon on long arm

05021728001	
○	950 PKL inch 1 x 0,05"x83 ¹⁾ ; 1 x 1/16"x91 ¹⁾ ; 1 x 5/64"x100; 1 x 3/32"x112; 1 x 7/64"x119; 1 x 1/8"x126; 1 x 9/64"x132; 1 x 5/32"x140; 1 x 3/16"x160; 1 x 7/32"x180; 1 x 1/4"x190; 1 x 5/16"x200; 1 x 3/8"x212

¹⁾ Regular hexagon

950/9 Hex-Plus Imperial 1 L-key set, imperial, BlackLaser



9-piece set in a two-component clip

Application: Hexagon socket screws

Design: BlackLaser surface

Tip: Hex-Plus, ball-end hexagon on long arm

05022171001	
○	950 PKL inch 1 x 5/64"x100; 1 x 3/32"x112; 1 x 1/8"x126; 1 x 5/32"x140; 1 x 3/16"x160; 1 x 7/32"x180; 1 x 1/4"x190; 1 x 5/16"x200; 1 x 3/8"x212

950/9 Hex-Plus Imperial 1 SB L-key set, imperial, BlackLaser

	4013288
05133180001	154118
○	950 PKL inch 1 x 5/64"x100; 1 x 3/32"x112; 1 x 1/8"x126; 1 x 5/32"x140; 1 x 3/16"x160; 1 x 7/32"x180; 1 x 1/4"x190; 1 x 5/16"x200; 1 x 3/8"x212

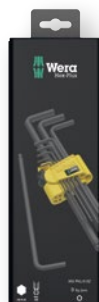

Tip



Are there any advantages of an L-key with an extra short arm?

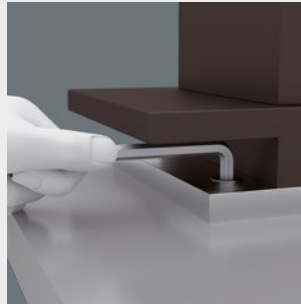

All users will recognise the need to saw or grind down L-keys to make them shorter for particularly confined screwdriving jobs. This has the disadvantage that they no longer have any corrosion protection at the separation point and secondly, they can become "soft" and therefore useless due to an alteration in the hardening during the shortening process.



L-Keys for Hexagon Socket Screws

The Hex-Plus profile extends the service life of hexagon socket screws

3950 SPKL Multicolour L-key, metric, stainless

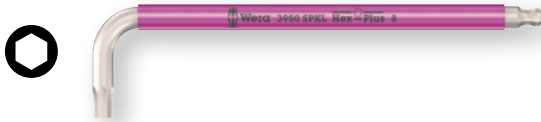

Application: Hexagon socket screws

Design: Stainless steel, durable plastic sleeve. The contrasting inscriptions on the colour-coded sleeves mean that it is easy to recognise the correct sizes and this makes it simpler to find the right tool.

Tip: Hex-Plus, ball-end hexagon on long arm

	⊙	L	L	L	L
	mm	mm	mm	"	"
05022660001	1,5	90	14	3 1/2"	9/16"
05022661001	2,0	101	16	4"	5/8"
05022662001	2,5	112	19	4 7/16"	3/4"
05022663001	3,0	123	21	4 7/8"	27/32"
05022664001	4,0	137	24	5 3/8"	1"
05022665001	5,0	154	27	6 1/16"	1 1/16"
05022666001	6,0	172	31	6 3/4"	1 1/4"
05022667001	8,0	195	37	7 11/16"	1 7/16"
05022668001	10,0	224	42	9"	1 11/16"

3950 PKL L-key, metric, stainless



Application: Hexagon socket screws

Design: Stainless steel

Tip: Hex-Plus, ball-end hexagon on long arm

	⊙	L	L	L	L
	mm	mm	mm	"	"
05022700001	1,5	90	14	3 1/2"	9/16"
05022701001	2,0	101	16	4"	5/8"
05022702001	2,5	112	19	4 7/16"	3/4"
05022703001	3,0	123	21	4 7/8"	27/32"
05022704001	4,0	137	24	5 3/8"	1"
05022705001	5,0	154	27	6 1/16"	1 1/16"
05022706001	6,0	172	31	6 3/4"	1 1/4"
05022708001	8,0	195	37	7 11/16"	1 7/16"
05022709001	10,0	224	42	9"	1 11/16"

3950 PKL L-key, imperial, stainless



Application: Hexagon socket screws

Design: Stainless steel

Tip: Hex-Plus, ball-end hexagon on long arm

	⊙	L	L	L	L
	"	mm	mm	"	"
05022710001	3/32"	112	19	4 7/16"	3/4"
05022711001	7/64"	119	20	4 3/4"	25/32"
05022712001	1/8"	123	21	4 7/8"	27/32"
05022713001	9/64"	130	22	5 3/16"	29/32"
05022714001	5/32"	137	24	5 3/8"	1"
05022715001	3/16"	154	27	6 1/16"	1 1/16"
05022716001	1/4"	185	34	7 1/4"	1 5/16"
05022717001	5/16"	195	37	7 11/16"	1 7/16"
05022718001	3/8"	224	42	9"	1 11/16"

950 SPKL HF L-key Multicolour, metric, with holding function



Application: Hexagon socket screws

Design: BlackLaser surface, durable plastic sleeve. The contrasting inscriptions on the colour-coded sleeves mean that it is easy to recognise the correct sizes and this makes it simpler to find the right tool.

Tip: Hex-Plus, ball-end hexagon on long arm, holding function for hexagon socket screws

	⊙	L	L	L	L
	mm	mm	mm	"	"
05022200001	3,0	123	21	4 7/8"	27/32"
05022201001	4,0	137	24	5 3/8"	1"
05022202001	5,0	154	27	6 1/16"	1 1/16"
05022203001	6,0	172	31	6 3/4"	1 1/4"
05022204001	8,0	195	37	7 11/16"	1 7/16"
05022205001	10,0	224	42	9"	1 11/16"

950 SPKL L-key Multicolour, metric



Application: Hexagon socket screws

Design: BlackLaser surface, durable plastic sleeve. The contrasting inscriptions on the colour-coded sleeves mean that it is easy to recognise the correct sizes and this makes it simpler to find the right tool.

Tip: Hex-Plus, ball-end hexagon on long arm

	⊙	L	L	L	L
	mm	mm	mm	"	"
05022600001	1,5	90	14	3 1/2"	9/16"
05022602001	2,0	101	16	4"	5/8"
05022604001	2,5	112	19	4 7/16"	3/4"
05022606001	3,0	123	21	4 7/8"	27/32"
05022608001	4,0	137	24	5 3/8"	1"
05022610001	5,0	154	27	6 1/16"	1 1/16"
05022612001	6,0	172	31	6 3/4"	1 1/4"
05022614001	8,0	195	37	7 11/16"	1 7/16"
05022616001	10,0	224	42	9"	1 11/16"

950 PKL L-key, metric, chrome-plated



Application: Hexagon socket screws

Design: Chrome-plated

Tip: Hex-Plus, ball-end hexagon on long arm

	⊙	L	L	L	L
	mm	mm	mm	"	"
05022050001 ¹⁾	1,5	90	14	3 1/2"	9/16"
05022052001	2,0	100	16	4"	5/8"
05022054001	2,5	112	18	4 7/16"	23/32"
05022056001	3,0	126	20	5"	25/32"
05022058001	4,0	140	25	5 1/2"	1"
05022060001	5,0	160	28	6 5/16"	1 3/32"
05022062001	6,0	180	32	7 1/16"	1 1/4"
05022063001	7,0	190	34	7 1/2"	1 5/16"
05022064001	8,0	200	36	8"	1 7/16"
05022066001	10,0	219	40	8 11/16"	1 9/16"
05022067001	12,0	248	45	10"	1 3/4"

¹⁾ Regular hexagon



950 SPKL L-key Multicolour, imperial



Application: Hexagon socket screws

Design: BlackLaser surface, durable plastic sleeve. The contrasting inscriptions on the colour-coded sleeves mean that it is easy to recognise the correct sizes and this makes it simpler to find the right tool.

Tip: Hex-Plus, ball-end hexagon on long arm

	⊙	L	L	L	L
	"	mm	mm	"	"
05022630001	5/64"	101	16	4"	5/8"
05022631001	3/32"	112	19	4 7/16"	3/4"
05022632001	1/8"	123	21	4 7/8"	27/32"
05022633001	5/32"	137	24	5 3/8"	1"
05022634001	3/16"	154	27	6 1/16"	1 1/16"
05022635001	7/32"	172	31	6 3/4"	1 1/4"
05022636001	1/4"	185	34	7 1/4"	1 5/16"
05022637001	5/16"	195	37	7 11/16"	1 7/16"
05022638001	3/8"	224	42	9"	1 11/16"

950 PKL BM L-key, metric, BlackLaser



Application: Hexagon socket screws

Design: BlackLaser surface

Tip: Hex-Plus, ball-end hexagon on long arm

	⊙	L	L	L	L
	mm	mm	mm	"	"
05027101001 ¹⁾	1,5	90	14	3 1/2"	9/16"
05027102001	2,0	100	16	4"	5/8"
05027103001	2,5	112	18	4 7/16"	23/32"
05027104001	3,0	126	19	5"	3/4"
05027105001	4,0	140	25	5 1/2"	1"
05027106001	5,0	160	28	6 5/16"	1 3/32"
05027107001	6,0	180	32	7 1/16"	1 1/4"
05027110001	7,0	190	34	7 1/2"	1 5/16"
05027108001	8,0	200	36	8"	1 7/16"
05027109001	10,0	219	40	8 11/16"	1 9/16"
05027111001	12,0	248	45	10"	1 3/4"

¹⁾ Regular hexagon

L-Keys for Hexagon Socket Screws

The Hex-Plus profile extends the service life of hexagon socket screws

950 PKL L-key, imperial, BlackLaser



Application: Hexagon socket screws

Design: BlackLaser surface

Tip: Hex-Plus, ball-end hexagon on long arm

	⊙	L ₁ mm	L ₂ mm	L ₃ "	L ₄ "
05022079001 ¹⁾	0,05"	83	14	3 1/4"	9/16"
05022081001 ¹⁾	1/16"	91	15	3 1/2"	19/32"
05022068001	5/64"	100	16	4"	5/8"
05022070001	3/32"	112	18	4 7/16"	23/32"
05022071001	7/64"	119	19	4 3/4"	3/4"
05022072001	1/8"	126	20	5"	25/32"
05022073001	9/64"	132	23	5 3/16"	29/32"
05022074001	5/32"	140	25	5 1/2"	1"
05022076001	3/16"	160	25	6 5/16"	1"
05022078001	7/32"	180	27	7 1/16"	1 1/16"
05022080001	1/4"	190	34	7 1/2"	1 5/16"
05022082001	5/16"	200	36	8"	1 7/16"
05022095001	3/8"	212	38	8 3/8"	1 1/2"
05022096001	1/2"	224	40	9"	1 9/16"

¹⁾ Regular hexagon

950 PKLS Long Arm Ballpoint Hex Key, metric, chrome plated



Application: For hexagon socket screws

Design: Chrome plated, with extra short arm for use on screws that are difficult to access

Tip: Hex-Plus, ballpoint hexagon on long arm

	⊙ mm	L ₁ mm	L ₂ mm	L ₃ mm	L ₄ mm
05022040001 ¹⁾	1,5	90	4,5	3 1/2"	11/64"
05022041001	2,0	100	5,5	4"	7/32"
05022042001	2,5	112	6,5	4 7/16"	1/4"
05022043001	3,0	126	7,5	5"	19/64"
05022044001	4,0	140	10,0	5 1/2"	25/64"
05022045001	5,0	160	12	6 5/16"	15/32"
05022046001	6,0	180	15	7 1/16"	19/32"
05022047001	8,0	200	19	8"	3/4"
05022048001	10,0	219	22	8 5/8"	7/8"

¹⁾ Regular hexagon

950 PKS L-key, metric, chrome-plated



Application: Hexagon socket screws

Design: Short, chrome-plated

Tip: Hex-Plus, ball-end hexagon on long arm

	⊙ mm	L ₁ mm	L ₂ mm	L ₃ mm	L ₄ mm
05133150001 ¹⁾	1,5	50	14	2"	9/16"
05133151001	2,0	56	16	2 7/32"	5/8"
05133152001	2,5	63	18	2 1/2"	23/32"
05133153001	3,0	71	20	2 3/4"	25/32"
05133154001	4,0	80	22	3"	29/32"
05133155001	5,0	90	25	3 1/2"	1"
05133156001	6,0	100	28	4"	1 3/32"
05133157001	8,0	112	32	4 7/16"	1 1/4"
05133158001	10,0	125	36	5"	1 5/16"

¹⁾ Regular hexagon

950 L-key, metric, chrome-plated



Application: Hexagon socket screws

Design: Chrome-plated

Tip: Hex-Plus

	⊙ mm	L ₁ mm	L ₂ mm	L ₃ mm	L ₄ mm
05021600001 ¹⁾	1,5	90	14	3 1/2"	9/16"
05021605001	2,0	100	16	4"	5/8"
05021610001	2,5	112	18	4 7/16"	23/32"
05021615001	3,0	126	20	5"	25/32"
05021620001	4,0	140	25	5 1/2"	1"
05021625001	5,0	160	28	6 5/16"	1 3/32"
05021630001	6,0	180	32	7 1/16"	1 1/4"
05021632001	7,0	190	30	7 1/2"	1 1/4"
05021635001	8,0	200	36	8"	1 7/16"
05021640001	10,0	219	40	8 11/16"	1 9/16"
05021645001	12,0	250	45	10"	1 3/4"

¹⁾ Regular hexagon

950 L-key, metric, chrome-plated



Application: Hexagon socket screws
Design: Chrome-plated
Tip: Hex-Plus

	⊙ mm	L ₁ mm	L ₂ mm	L ₃ mm	L ₄ mm
05021005001 ¹⁾	1,5	45	14	1 3/4"	9/16"
05021010001	2,0	50	16	2"	5/8"
05021015001	2,5	56	18	2 7/32"	23/32"
05021020001	3,0	63	20	2 1/2"	25/32"
05021025001	3,5	66	23	2 5/8"	29/32"
05021030001	4,0	70	25	2 3/4"	1"
05021035001	4,5	75	26	3"	1 1/32"
05021040001	5,0	80	28	3 1/8"	1 3/32"
05021045001	6,0	90	32	3 1/2"	1 1/4"
05021050001	7,0	95	34	3 3/4"	1 5/16"
05021055001	8,0	100	36	4"	1 7/16"
05021060001	9,0	106	38	4 3/16"	1 1/2"
05021065001	10,0	112	40	4 7/16"	1 9/16"
05021070001	11,0	120	43	4 3/4"	1 11/16"
05021075001	12,0	125	45	5"	1 3/4"
05021080001	13,0	132	50	5 3/16"	2"
05021085001 ¹⁾	14,0	140	56	5 1/2"	2 7/32"
05021090001 ¹⁾	17,0	160	63	6 5/16"	2 1/2"
05021095001 ¹⁾	19,0	180	70	7 1/16"	2 3/4"
05021100001 ¹⁾	22,0	200	80	8"	3 1/8"
05021105001 ¹⁾	24,0	224	90	9"	3 1/2"
05021110001 ¹⁾	27,0	250	100	10"	4"

¹⁾ Regular hexagon.

950 BM L-key, metric, BlackLaser



Application: Hexagon socket screws
Design: BlackLaser surface
Tip: Hex-Plus

	⊙ mm	L ₁ mm	L ₂ mm	L ₃ mm	L ₄ mm
05027201001 ¹⁾	1,5	45	14	1 3/4"	9/16"
05027202001	2,0	50	16	2"	5/8"
05027203001	2,5	56	18	2 7/32"	23/32"
05027204001	3,0	63	20	2 1/2"	25/32"
05027205001	3,5	66	23	2 5/8"	29/32"
05027206001	4,0	70	25	2 3/4"	1"
05027207001	4,5	75	26	3"	1 1/32"
05027208001	5,0	80	28	3 1/8"	1 3/32"
05027209001	6,0	90	32	3 1/2"	1 1/4"
05027210001	7,0	95	34	3 3/4"	1 5/16"
05027211001	8,0	100	36	4"	1 7/16"
05027213001	9,0	106	38	4 11/64"	1 1/2"
05027212001	10,0	112	40	4 7/16"	1 9/16"
05027214001	11,0	120	43	4 23/32"	1 11/16"
05027215001	12,0	125	45	5"	1 49/64"

¹⁾ Regular hexagon.



L-Keys for TORX® Screws

Powerful, ergonomic, long service life

967/9 TX XL Multicolour HF 1 L-key set with holding function, long

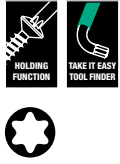

9-piece set in a two-component clip

Application: TORX® socket screws

Blade: Zinc-phosphated, durable plastic sleeve. The contrasting inscriptions on the colour-coded sleeves mean that it is easy to recognise the correct sizes and this makes it simpler to find the right tool.

Design: Holding function for TORX® screws made according to Acument Intellectual Properties specifications

05024470001		
	♻️	967 SXL 1 x TX 8x90; 1 x TX 9x101; 1 x TX 10x112; HF TORX® 1 x TX 15x123; 1 x TX 20x137; 1 x TX 25x154; Multicolour 1 x TX 27x172; 1 x TX 30x195; 1 x TX 40x224

967/9 TX XL HF 1 L-key set with holding function, long



9-piece set in a two-component clip

Application: TORX® socket screws

Blade: zinc-phosphated

Design: Holding function for TORX® screws made according to Acument Intellectual Properties specifications

05024450001		
	♻️	967 XL HF 1 x TX 8x90; 1 x TX 9x101; 1 x TX 10x112; TORX® 1 x TX 15x123; 1 x TX 20x137; 1 x TX 25x154; 1 x TX 27x172; 1 x TX 30x195; 1 x TX 40x224

967/9 TX Multicolour HF 1 L-key set with holding function



9-piece set in a two-component clip

Application: TORX® socket screws

Blade: Round

Design: Holding function for TORX® screws made according to Acument Intellectual Properties specifications, BlackLaser surface, durable plastic sleeve. The contrasting inscriptions on the colour-coded sleeves mean that it is easy to recognise the correct sizes and this makes it simpler to find the right tool.

05024179001		
	♻️	967 SL TORX® 1 x TX 8x76; 1 x TX 9x79; 1 x TX 10x85; HF 1 x TX 15x90; 1 x TX 20x96; 1 x TX 25x104; 1 x TX 27x112; 1 x TX 30x122; 1 x TX 40x132

967/9 TX HF 1 L-key set with holding function, BlackLaser



9-piece set in a two-component clip

Application: TORX® socket screws

Blade: Round

Design: Holding function for TORX® screws made according to Acument Intellectual Properties specifications, BlackLaser surface

05024244001		
	♻️	967 L TORX® 1 x TX 8x76; 1 x TX 9x79; 1 x TX 10x85; HF 1 x TX 15x90; 1 x TX 20x96; 1 x TX 25x104; 1 x TX 27x112; 1 x TX 30x122; 1 x TX 40x132

967/9 TX XL Multicolour 1 Multicolour L-key set for TORX® screws, long



9-piece set in a two-component clip

Application: TORX® socket screws

Design: Zinc-phosphated, durable plastic sleeve. The contrasting inscriptions on the colour-coded sleeves mean that it is easy to recognise the correct sizes and this makes it simpler to find the right tool.

Tip: TORX® on short arm, TORX® ball end on long arm, TX 8, TX 9, TX 10: without ball-end at the long arm

05024480001	
	967 SXL 1 x TX 8x90; 1 x TX 9x101; 1 x TX 10x112 TORX® Multicolour
	967 SPKXL 1 x TX 15x123; 1 x TX 20x137; 1 x TX 25x154; TORX® 1 x TX 27x172; 1 x TX 30x195; 1 x TX 40x224 Multicolour

Tip



The HF profile

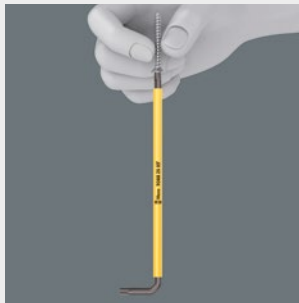

In tight assembly or disassembly situations, for example in engine compartments, it is not possible to securely hold the screw with the hand on the screwdriver, and the screw subsequently often gets lost. Lengthy searches or the loss of the screw (with the associated danger that could bring about) are the consequence. The HF tools

developed by Wera are ideal because they feature an optimised geometry of the original TORX® profile. The wedging forces resulting from the surface pressure between the drive tip and the screw profile mean that the screw is securely held on the tool!



“Take it easy”



“Take it easy” tool finder system – with profile and size colour-coding for quick and easy tool selection. Colour-coded system for hexagon drive screws (L-Keys, Zyklop bit sockets), external hex drive screws and nuts (Joker wrenches, Zyklop sockets and Zyklop bit sockets with holding function), and TORX® drive screws (L-Keys, Zyklop bit sockets).



L-Keys for TORX® Screws

Powerful, ergonomic, long service life

967/9 TX BO Multicolour 1 L-key set for tamper-proof TORX® screws, BlackLaser

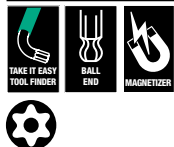

9-piece set in a two-component clip. For recessed screws, it's often advantageous for the screw to be held on the L-key by magnetic force. The Wera clips with magnetiser/demagnetiser enable a magnetisation/demagnetisation of L-keys in a flash.

Application: TORX® socket screws with and without pin (BO = bore hole)

Design: BlackLaser, durable plastic sleeve. The contrasting inscriptions on the colour-coded sleeves mean that it is easy to recognise the correct sizes and this makes it simpler to find the right tool.

Tip: TORX® on short arm, TORX® ball end on long arm

05024335001		
	♻️♻️	967 SPKL 1 x TX 8x76 ¹⁾ ; 1 x TX 9x79 ¹⁾ ; 1 x TX 10x85 ²⁾ ; TORX® BO 1 x TX 15x90; 1 x TX 20x96; 1 x TX 25x104; Multicolour 1 x TX 27x112; 1 x TX 30x122; 1 x TX 40x132

¹⁾ Product without bore hole at the short and without ball-end at the long arm.

²⁾ Product without ball-end at the long arm.

967/9 TX BO Multicolour 1 SB, TORX® BO L-key set for tamper-proof TORX® screws, BlackLaser

		4013288
05073599001		170125
	♻️♻️	967 SPKL TORX® BO Multicolour 1 x TX 8x76 ¹⁾ ; 1 x TX 9x79 ¹⁾ ; 1 x TX 10x85 ²⁾ ; 1 x TX 15x90; 1 x TX 20x96; 1 x TX 25x104; 1 x TX 27x112; 1 x TX 30x122; 1 x TX 40x132



¹⁾ Product without bore hole at the short and without ball-end at the long arm.

²⁾ Product without ball-end at the long arm.

967/9 TX XL 1 TORX® L-key set, long



9-piece set in a two-component clip

Application: TORX® socket screws

Design: Zinc-phosphated

Tip: TORX® on short arm, TORX® ball end on long arm, TX 8, TX 9, TX 10: without ball-end at the long arm

05024460001		
	♻️♻️	967 XL TORX® 1 x TX 8x90; 1 x TX 9x101; 1 x TX 10x112
	♻️♻️	967 PKXL TORX® 1 x TX 15x123; 1 x TX 20x137; 1 x TX 25x154; 1 x TX 27x172; 1 x TX 30x195; 1 x TX 40x224

967/9 TX 1 L-key set, BlackLaser



9-piece set in a two-component clip

Application: TORX® socket screws

Design: BlackLaser surface

Tip: TORX® on short arm, TORX® ball end on long arm

05024242001		
	♻️♻️	967 PKL TORX® 1 x TX 8x76 ¹⁾ ; 1 x TX 9x79 ¹⁾ ; 1 x TX 10x85 ¹⁾ ; 1 x TX 15x90; 1 x TX 20x96; 1 x TX 25x104; 1 x TX 27x112; 1 x TX 30x122; 1 x TX 40x132

¹⁾ Product without ball-end at the long arm.

967/9 TX 1 SB L-key set, BlackLaser

		4013288
05073598001		106438
	♻️♻️	967 PKL TORX® 1 x TX 8x76 ¹⁾ ; 1 x TX 9x79 ¹⁾ ; 1 x TX 10x85 ¹⁾ ; 1 x TX 15x90; 1 x TX 20x96; 1 x TX 25x104; 1 x TX 27x112; 1 x TX 30x122; 1 x TX 40x132



¹⁾ Product without ball-end at the long arm.

967 SXL HF TORX® L-key Multicolour with holding function, long



Application: TORX® socket screws

Design: zinc-phosphated, durable plastic sleeve. The contrasting inscriptions on the colour-coded sleeves mean that it is easy to recognise the correct sizes and this makes it simpler to find the right tool.

Tip: Holding function for TORX® screws made according to Acument Intellectual Properties specifications

		mm	mm		
05024471001	TX 8	90	16	3 1/2"	5/8"
05024472001	TX 9	101	16	4"	5/8"
05024473001	TX 10	112	19	4 7/16"	3/4"
05024474001	TX 15	123	21	4 7/8"	27/32"
05024475001	TX 20	137	24	5 3/8"	1"
05024476001	TX 25	154	27	6 1/16"	1 1/16"
05024477001	TX 27	172	31	6 3/4"	1 1/4"
05024478001	TX 30	195	37	7 11/16"	1 7/16"
05024479001	TX 40	224	42	9"	1 11/16"

967 SPKXL TORX® L-key Multicolour, long



Application: TORX® socket screws

Design: zinc-phosphated, durable plastic sleeve. The contrasting inscriptions on the colour-coded sleeves mean that it is easy to recognise the correct sizes and this makes it simpler to find the right tool.

Tip: TORX® on short arm, TORX® ball end on long arm

		mm	mm		
05024484001	TX 15	123	21	4 7/8"	27/32"
05024485001	TX 20	137	24	5 3/8"	1"
05024486001	TX 25	154	27	6 1/16"	1 1/16"
05024487001	TX 27	172	31	6 3/4"	1 1/4"
05024488001	TX 30	195	37	7 11/16"	1 7/16"
05024489001	TX 40	224	42	9"	1 11/16"

Tip



The HF profile

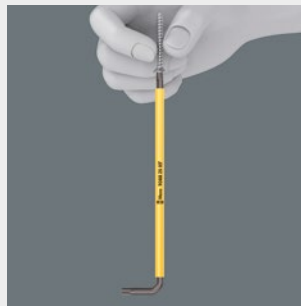

In tight assembly or disassembly situations, for example in engine compartments, it is not possible to securely hold the screw with the hand on the screwdriver, and the screw subsequently often gets lost. Lengthy searches or the loss of the screw (with the associated danger that could bring about) are the consequence. The HF tools

developed by Wera are ideal because they feature an optimised geometry of the original TORX® profile. The wedging forces resulting from the surface pressure between the drive tip and the screw profile mean that the screw is securely held on the tool!



"Take it easy"

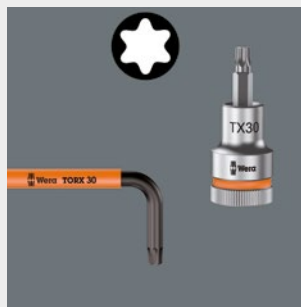

"Take it easy" tool finder system – with profile and size colour-coding for quick and easy tool selection. Colour-coded system for hexagon drive screws (L-Keys, Zyklop bit sockets), external hex drive screws and nuts (Joker wrenches, Zyklop sockets and Zyklop bit sockets with holding function), and TORX® drive screws (L-Keys, Zyklop bit sockets).



Ball tip



The spherical drive profile means that it is possible to swivel the axis of the tool to that of the screw, and therefore enable angled, "around-the-corner" screwdriving jobs.

L-Keys for TORX® Screws

Powerful, ergonomic, long service life

967 SL TORX® HF L-key Multicolour with holding function



Application: TORX® socket screws

Blade: Round

Design: Holding function for TORX® screws made according to Acument Intellectual Properties specifications, BlackLaser, durable plastic sleeve. The contrasting inscriptions on the colour-coded sleeves mean that it is easy to recognise the correct sizes and this makes it simpler to find the right tool.

		L ₁ mm	L ₂ mm	L ₃ "	L ₄ "
05024170001	TX 8	76	16	3"	5/8"
05024171001	TX 9	79	16	3 1/8"	5/8"
05024172001	TX 10	85	17	3 1/4"	21/32"
05024173001	TX 15	90	18	3 1/2"	23/32"
05024174001	TX 20	96	19	3 3/4"	3/4"
05024175001	TX 25	104	21	4 1/8"	27/32"
05024176001	TX 27	112	22	4 7/16"	29/32"
05024177001	TX 30	122	24	4 13/16"	1"
05024178001	TX 40	132	27	5 3/16"	1 1/16"

967 SPKL TORX® B0 L-key Multicolour



Application: TORX® socket screws with and without pin (B0 = bore hole)

Design: BlackLaser, durable plastic sleeve. The contrasting inscriptions on the colour-coded sleeves mean that it is easy to recognise the correct sizes and this makes it simpler to find the right tool.

Tip: TORX® on short arm, TORX® ball end on long arm

		L ₁ mm	L ₂ mm	L ₃ "	L ₄ "
05024350001 ¹⁾	TX 8	76	16	3"	5/8"
05024351001 ¹⁾	TX 9	79	16	3 1/8"	5/8"
05024352001 ²⁾	TX 10	85	17	3 3/8"	21/32"
05024353001	TX 15	90	18	3 1/2"	23/32"
05024354001	TX 20	96	19	3 3/4"	3/4"
05024355001	TX 25	104	21	4 1/8"	27/32"
05024356001	TX 27	112	22	4 7/16"	29/32"
05024357001	TX 30	122	24	4 13/16"	1"
05024358001	TX 40	132	27	5 3/16"	1 1/16"

¹⁾ Product without bore hole at the short and without ball-end at the long arm.

²⁾ Product without ball-end at the long arm.

967 SXL TORX® L-key Multicolour, long



Application: TORX® socket screws

Design: zinc-phosphated, durable plastic sleeve. The contrasting inscriptions on the colour-coded sleeves mean that it is easy to recognise the correct sizes and this makes it simpler to find the right tool.

Tip: TORX®

		L ₁ mm	L ₂ mm	L ₃ "	L ₄ "
05024481001	TX 8	90	16	3 1/2"	5/8"
05024482001	TX 9	101	16	4"	5/8"
05024483001	TX 10	112	19	4 7/16"	3/4"

967 XL HF TORX® L-key with holding function, long



Application: TORX® socket screws

Design: zinc-phosphated

Tip: Holding function for TORX® screws made according to Acument Intellectual Properties specifications

		L ₁ mm	L ₂ mm	L ₃ "	L ₄ "
05024451001	TX 8	90	16	3 1/2"	5/8"
05024452001	TX 9	101	16	4"	5/8"
05024453001	TX 10	112	19	4 7/16"	3/4"
05024454001	TX 15	123	21	4 7/8"	27/32"
05024455001	TX 20	137	24	5 3/8"	1"
05024456001	TX 25	154	27	6 1/16"	1 1/16"
05024457001	TX 27	172	31	6 3/4"	1 1/4"
05024458001	TX 30	195	37	7 11/16"	1 7/16"
05024459001	TX 40	224	42	9"	1 11/16"



L-Keys for TORX® Screws

Powerful, ergonomic, long service life

967 PKXL TORX® L-key, long



Application: TORX® socket screws

Design: zinc-phosphated

Tip: TORX® on short arm, TORX® ball end on long arm

		mm	mm	"	"
05024464001	TX 15	123	21	4 7/8"	27/32"
05024465001	TX 20	137	24	5 3/8"	1"
05024466001	TX 25	154	27	6 1/16"	1 1/16"
05024467001	TX 27	172	31	6 3/4"	1 1/4"
05024468001	TX 30	195	37	7 11/16"	1 7/16"
05024469001	TX 40	224	42	9"	1 1/16"

967 XL TORX® L-key, lang



Application: TORX® socket screws

Design: zinc-phosphated

Tip: TORX®

		mm	mm	"	"
05024461001	TX 8	90	16	3 1/2"	5/8"
05024462001	TX 9	101	16	4"	5/8"
05024463001	TX 10	112	19	4 7/16"	3/4"

967 PKL TORX® L-key, BlackLaser



Application: TORX® socket screws

Design: BlackLaser surface

Tip: TORX® on short arm, TORX® ball end on long arm

		mm	mm	"	"
05024199001 ¹⁾	TX 8	76	16	3"	5/8"
05024100001 ¹⁾	TX 9	79	16	3 1/8"	5/8"
05024105001 ¹⁾	TX 10	85	17	3 3/8"	21/32"
05024200001	TX 15	90	18	3 1/2"	23/32"
05024202001	TX 20	96	19	3 3/4"	3/4"
05024204001	TX 25	104	21	4 1/8"	27/32"
05024206001	TX 27	112	22	4 7/16"	29/32"
05024208001	TX 30	122	24	4 13/16"	1"
05024210001	TX 40	132	27	5 3/16"	1 1/16"

¹⁾ Product without ball-end at the long arm.

967 L TORX® HF L-key with holding function, BlackLaser



Application: TORX® socket screws

Blade: Round, BlackLaser surface

Design: Holding function for TORX® screws made according to Acument Intellectual Properties specifications

		mm	mm	"	"
05024160001	TX 8	76	16	3"	5/8"
05024161001	TX 9	79	16	3 1/8"	5/8"
05024162001	TX 10	85	17	3 1/4"	21/32"
05024163001	TX 15	90	18	3 1/2"	23/32"
05024164001	TX 20	96	19	3 3/4"	3/4"
05024165001	TX 25	104	21	4 1/8"	27/32"
05024166001	TX 27	112	22	4 7/16"	29/32"
05024167001	TX 30	122	24	4 13/16"	1"
05024168001	TX 40	132	27	5 3/16"	1 1/16"

967 TORX® L-key, BlackLaser



Application: TORX® socket screws

Design: BlackLaser surface

Tip: TORX®

		mm	mm	"	"
05024001001	TX 6	42	16	1 5/8"	5/8"
05024002001	TX 7	48	16	1 7/8"	5/8"
05024003001	TX 8	48	16	1 7/8"	5/8"
05024004001	TX 9	48	16	1 7/8"	5/8"
05024005001	TX 10	51	17	2"	21/32"
05024008001	TX 15	54	18	2 1/8"	23/32"
05024010001	TX 20	57	19	2 1/4"	3/4"
05024012001	TX 25	60	20	2 3/8"	25/32"
05024013001	TX 27	64	21	2 1/2"	27/32"
05024015001	TX 30	70	24	2 3/4"	1"
05024020001	TX 40	76	26	3"	1 1/32"

Offset Screwdrivers

Suitable for slotted, Phillips and Pozidriv screws

919 PH Offset Screwdriver



Application: For Phillips screws
Blade: 90° + 180°, mat nickel

	+	┌ mm	└ mm	┌ mm	└ mm
05017205001	PH1+2	125	20	5"	25/32"

919 PZ Offset Screwdriver



Application: Suitable for Pozidriv-screws
Blade: 90° + 180°, BlackLaser

	*	┌ mm	└ mm	┌ mm	└ mm
05017305001	PZ1+2	125	20	5"	25/32"

920 A Offset Screwdriver













Application: For Slotted screws
Blade: 90° + 180°, mat nickel

	○	┌ mm	└ mm	┌ mm	└ mm
05017405001	4,0+4,0	100	12	4"	1/2"
05017410001	5,5+5,5	125	16	5"	5/8"
05017415001	8,0+8,0	150	20	6"	25/32"

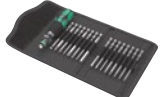



Kraftform Kompakt

	Kraftform Kompakt 10, 12	262
	Kraftform Kompakt 20, 22, 25, 26, 28	264
	Kraftform Kompakt 40, 41	268
	Kraftform Kompakt 50	269
	Kraftform Kompakt 60, 62	270
	Kraftform Kompakt 70, 71	276
	Kraftform Kompakt 100	278
	Kraftform Kompakt User Sets	280
	Bitholding Screwdrivers and Adaptors	284
	Kraftform Kompakt Vario With Ratchet Function	288
	Kraftform Kompakt Vario Without Ratchet Function	292



Kraftform Kompakt

Why is the right tool so often not at hand? The reason: too many tools and overly-heavy tool bags can make it bothersome to carry them onsite.

So for us it was a clear challenge: to design a tool that is suitable for a whole host of applications and can be easily taken along to jobs at other sites.

Our solution: Kraftform Kompakt tools. A handle into which blades with a range of different profiles can be inserted. Compactly and protectively housed in a light and robust textile pouch or plastic box.

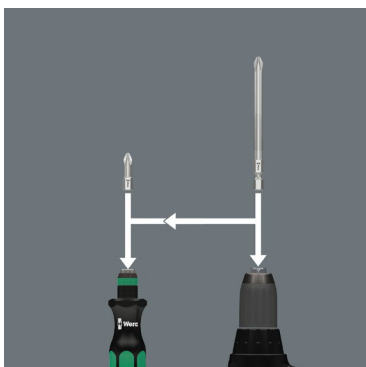

The sets come with a Kraftform handle, quick-release chuck and bits for manual and power tool operations.



The handle/interchangeable blade system permits rapid exchange of the blades needed for a wide range of applications.



The tools can be stored and carried either in a solid plastic case or a robust pouch. In this way the tool is always to hand. Kraftform Kompakt Sets with Zyklop Speed or Zyklop Mini ratchet can be found on pages 146, 216-223.



Kraftform Kompakt user ranges – the new special sets – compact yet very versatile. Suitable for all sanitary, wood, metal or electrical applications.

Kraftform Kompakt 10, 12

A screwdriver set can hardly be more compact.

Kraftform Kompakt 10



10-piece set

1 bitholding screwdriver 813 R Kraftform with quick-release chuck Rapidaptor

05056653001	
●	813 R 1 x 1/4"x90
+	851/1 TZ PH 1 x PH 1x25; 1 x PH 2x25
+	855/1 TZ PZ 1 x PZ 1x25; 1 x PZ 2x25
+	867/1 TZ TORX® 1 x TX 10x25; 1 x TX 15x25; 1 x TX 20x25
●	800/1 TZ 1 x 0,5x4,0x25; 1 x 1,0x5,5x25

Kraftform Kompakt 12



10-piece set

1 bitholding screwdriver 813 R Kraftform with quick-release chuck Rapidaptor

05135942001	
●	813 R 1 x 1/4"x90
+	867/1 TZ TORX® 1 x TX 5x25; 1 x TX 6x25; 1 x TX 7x25; 1 x TX 8x25; 1 x TX 9x25
+	851/1 J 1 x PH 00x25x2,0; 1 x PH 0x25x2,5; 1 x PH 1x25x3,0
+	851/1 TZ PH 1 x PH 2x25





Kraftform Kompakt 20, 22, 25, 26, 28

Telescopic blade models

Kraftform Kompakt 20 A

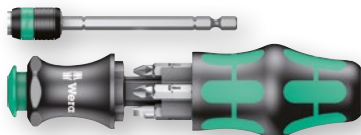

Application: Suitable for 1/4" DIN ISO 1173-C 6,3 and E 6,3 hexagon socket insert bits and Wera Series 1 and 4

Design: Attachment, telescopic, Rapidaptor rapid-in, rapid-out, rapid-spin, chuck-all and single-hand technology

Handle: Kraftform with non-roll feature, multi-component, integrated magazine

05051019001	
⊙ ⊙	889/4 R 1 x 1/4"x100
+	851/1 Z PH 1 x PH 1x25; 1 x PH 2x25
+	855/1 Z PZ 1 x PZ 1x25; 1 x PZ 2x25
⊖	800/1 Z 1 x 1,0x5,5x25; 1 x 1,2x6,5x25

Kraftform Kompakt 20 with pouch



Application: Suitable for 1/4" DIN ISO 1173-C 6,3 and E 6,3 hexagon socket insert bits and Wera Series 1 and 4

Design: Attachment, telescopic, Rapidaptor rapid-in, rapid-out, rapid-spin, chuck-all and single-hand technology

Handle: Kraftform with non-roll feature, multi-component, integrated magazine

05051021001	
⊙ ⊙	889/4 R 1 x 1/4"x100
+	851/1 Z PH 1 x PH 1x25; 1 x PH 2x25
+	855/1 Z PZ 1 x PZ 1x25; 1 x PZ 2x25
⊖	800/1 Z 1 x 1,0x5,5x25; 1 x 1,2x6,5x25

Kraftform Kompakt 20 Tool Finder 1 with pouch

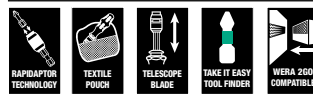

Application: Suitable for 1/4" DIN ISO 1173-C 6.3 and E 6.3 hexagon socket insert bits and Wera Series 1 and 4

Design: Attachment, telescopic, Rapidaptor rapid-in, rapid-out, rapid-spin, chuck-all and single-hand technology; Take it easy toolfinder: Output colour coding and large stamp to enable the desired bit to be easily located

Handle: Kraftform with non-roll feature, multi-component, integrated magazine

05051016001	
⊙ ⊙	889/4 R 1 x 1/4"x100
+	851/1 BTZ PH 1 x PH 1x25; 1 x PH 2x25
+	855/1 BTZ PZ 1 x PZ 1x25; 1 x PZ 2x25
⊙	867/1 TORX® 1 x TX 25x25
	BTZ
⊖	800/1 BTZ 1 x 0,8x5,5x25

Kraftform Kompakt 22 with pouch



Application: Suitable for 1/4" DIN ISO 1173-C 6,3 and E 6,3 hexagon socket insert bits and Wera Series 1 and 4

Design: Attachment, telescopic, Rapidaptor rapid-in, rapid-out, rapid-spin, chuck-all and single-hand technology

Handle: Kraftform with non-roll feature, multi-component, integrated magazine

05051023001	
⊙ ⊙	889/4 R 1 x 1/4"x100
+	855/1 Z PZ 1 x PZ 1x25; 2 x PZ 2x25
⊙	867/1 Z TORX® 1 x TX 15x25; 1 x TX 20x25; 1 x TX 25x25



Kraftform Kompakt 20, 22, 25, 26, 28

Telescopic blade models

Kraftform Kompakt 25 with pouch



Application: Suitable for 1/4" DIN ISO 1173-C 6,3 and E 6,3 hexagon socket insert bits and Wera Series 1 and 4

Design: Attachment, telescopic, Rapidaptor rapid-in, rapid-out, rapid-spin, chuck-all and single-hand technology

Handle: Kraftform with non-roll feature, multi-component, integrated magazine

05051024001	
● ○	889/4 R 1 x 1/4"x100
⊕	851/1 Z PH 1 x PH 1x25; 1 x PH 2x25; 1 x PH 3x25
●	800/1 Z 1 x 0,6x4,5x25; 1 x 1,0x5,5x25; 1 x 1,2x6,5x25

Kraftform Kompakt 26 with pouch



Application: Suitable for 1/4" DIN ISO 1173-C 6,3 and E 6,3 hexagon socket insert bits and Wera Series 1 and 4

Design: Attachment, telescopic, Rapidaptor rapid-in, rapid-out, rapid-spin, chuck-all and single-hand technology

Handle: Kraftform with non-roll feature, multi-component, integrated magazine

05051025001	
● ○	889/4 R 1 x 1/4"x100
⊕	851/1 Z PH 1 x PH 1x25; 1 x PH 2x25
●	800/1 Z 1 x 1,0x5,5x25; 1 x 1,2x6,5x25
○	868/1 Z 1 x # 1x25; 1 x # 2x25

Kraftform Kompakt 28 SB

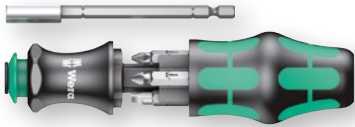

Application: Suitable for 1/4" DIN ISO 1173-C 6,3 hexagon socket insert bits and Wera Series 1

Design: Attachment, telescopic, with stainless steel sleeve, retaining ring, and strong permanent magnet

Handle: Kraftform with non-roll feature, multi-component, integrated magazine

05073240001	
	851/1 Z PH 1 x PH 1x25; 1 x PH 2x25
	855/1 Z PZ 1 x PZ 1x25; 1 x PZ 2x25
	800/1 Z 1 x 1,0x5,5x25; 1 x 1,2x6,5x25

Kraftform Kompakt 28 with pouch



Application: Suitable for 1/4" DIN ISO 1173-C 6,3 hexagon socket insert bits and Wera Series 1

Design: Attachment, telescopic, with stainless steel sleeve, retaining ring, and strong permanent magnet

Handle: Kraftform with non-roll feature, multi-component, integrated magazine

05134491001	
	800/1 Z 1 x 1,0x5,5x25; 1 x 1,2x6,5x25
	851/1 Z PH 1 x PH 1x25; 1 x PH 2x25
	855/1 Z PZ 1 x PZ 1x25; 1 x PZ 2x25

Tip

Telescopic blade, integrated bit magazine, Rapidaptor technology



The sets in the series Kraftform Kompakt 20 are really something. A 2 position telescopic blade can be retracted into the handle for confined space operation or extended for more reach. It can also be removed and used as a 100mm bit holder in the power tool. Six bits are conveniently integrated into a push-button opening bit magazine.

The Rapidaptor technology ensures rapid one hand bit changes, press-in auto bit lock and a secure positioning when used in power tools thanks to the free-turning sleeve.



The telescopic blade

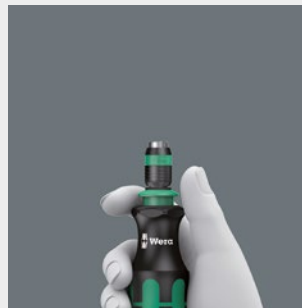

When the unique telescopic blade is lowered into the handle, fast, easy screw-driving action is possible, even in the tightest spots!

By pushing the clamping sleeve, the telescopic blade can be extended out of the handle and the compact tool becomes a full-sized screwdriver.

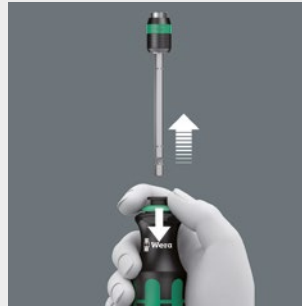

If the clamping sleeve is pushed again the telescopic blade can be taken out of the handle, and be used as a machine bit adaptor.



Kraftform Kompakt 40 and 41

Bits of 89 mm in length

Kraftform Kompakt 40



Pouch with 89 mm bits

7-piece set

1 Kraftform bitholding screwdriver 816 R with Rapidaptor quick-release chuck

05059298001		
●	816 R	1 x 1/4"x119
⊕	851/4 Z PH	1 x PH 1x89; 1 x PH 2x89
⊕	855/4 Z PZ	1 x PZ 1x89; 1 x PZ 2x89
●	800/4 Z	1 x 1,0x5,5x89; 1 x 1,2x6,5x89

Kraftform Kompakt 41



Pouch with 89 mm bits

11-piece set

1 Kraftform bitholding screwdriver 816 R with Rapidaptor quick-release chuck

05059299001		
●	816 R	1 x 1/4"x119
⊕	851/4 Z PH	1 x PH 1x89; 1 x PH 2x89; 1 x PH 3x89
⊕	855/4 Z PZ	1 x PZ 1x89; 1 x PZ 2x89; 1 x PZ 3x89
⊕	867/4 Z TORX® B0	1 x TX 15x89; 1 x TX 20x89; 1 x TX 25x89; 1 x TX 30x89

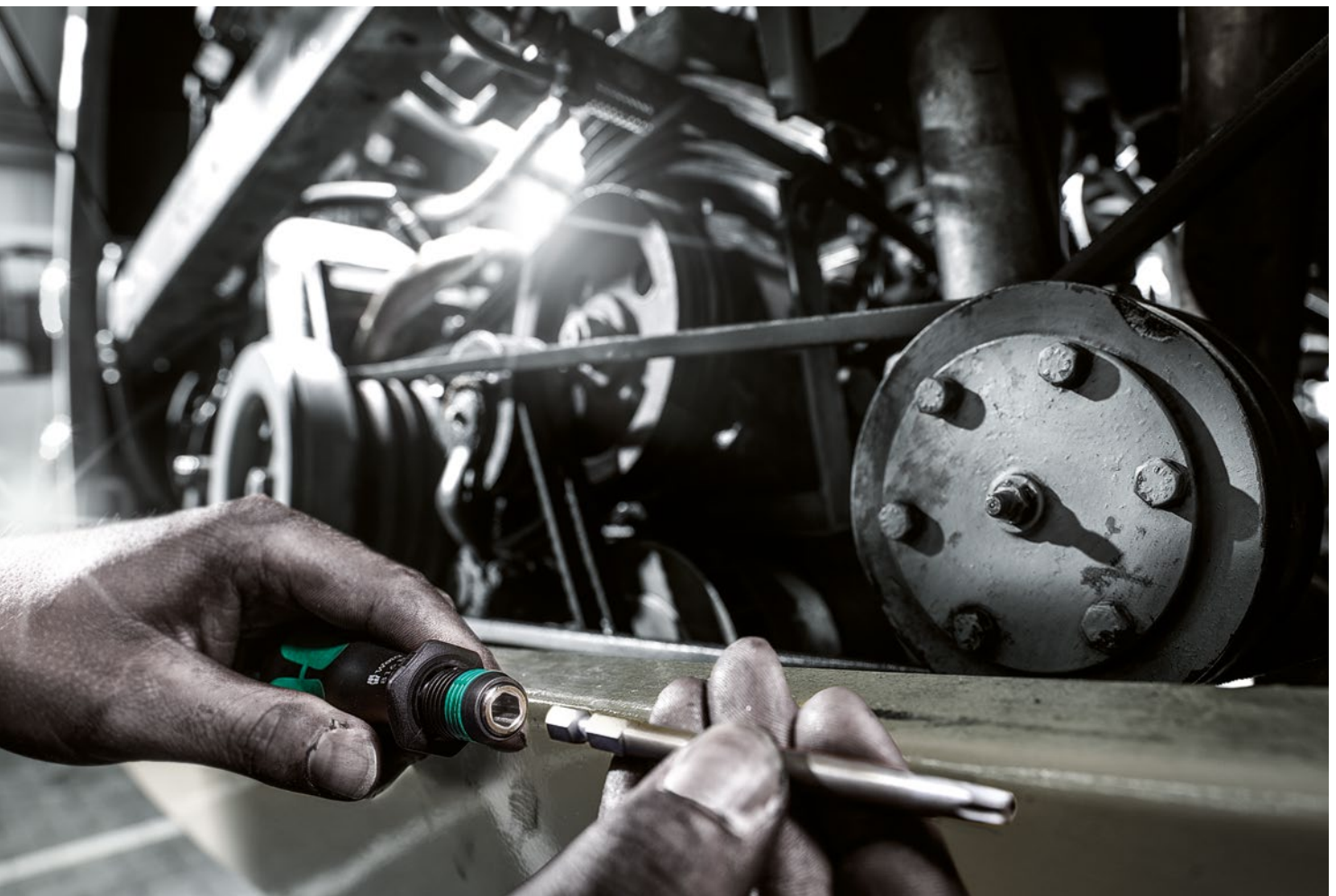

Kraftform Kompakt 50

Telescopic blade model

Kraftform Kompakt 50

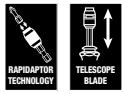

14-piece set

1 Kraftform bitholding screwdriver 817 R and telescopic blade with quick-release chuck Rapidaptor

05056656001	
●	817 R 1 x 1/4"x133
●	889/4 R 1 x 1/4"x100
+	851/1 Z PH 1 x PH 1x25; 1 x PH 2x25
+	855/1 Z PZ 1 x PZ 1x25; 1 x PZ 2x25
⊕	867/1 Z TORX® BO 1 x TX 10x25; 1 x TX 15x25; 1 x TX 20x25; 1 x TX 25x25; 1 x TX 30x25; 1 x TX 40x25
●	800/1 Z 1 x 0,6x4,5x25; 1 x 1,0x5,5x25



Tip



The telescopic blade



When the unique telescopic blade is lowered into the handle, fast, easy screw-driving action is possible, even in the tightest spots!

By pushing the clamping sleeve, the telescopic blade can be extended out of the handle and the compact tool becomes a full-sized screwdriver.



If the clamping sleeve is pushed again the telescopic blade can be taken out of the handle, and be used as a machine bit adaptor.



Kraftform Kompakt 60, 62

Bits of 89 mm in length

Kraftform Kompakt 60 Torque 1.2 - 3.0 Nm



Pouch with 89 mm bits

17-piece set

1 Series 7400 Kraftform adjustable torque screwdriver (1.2-3.0 Nm) with Rapidaptor quick-release chuck

05059293001		
7400	1 x 7441x1/4"x1,2-3,0x155	
851/4 Z PH	1 x PH 1x89; 1 x PH 2x89; 1 x PH 3x89	
855/4 Z PZ	1 x PZ 1x89; 1 x PZ 2x89; 1 x PZ 3x89	
867/4 Z TORX® BO	1 x TX 10x89; 1 x TX 15x89; 1 x TX 20x89; 1 x TX 25x89; 1 x TX 30x89	
800/4 Z	1 x 1,0x5,5x89	
840/4 Z Hex-Plus	1 x 3,0x89; 1 x 4,0x89; 1 x 5,0x89; 1 x 6,0x89	

Kraftform Kompakt 60, stainless



Pouch with 89 mm bits, stainless steel

17-piece set

1 Kraftform stainless bitholding screwdriver 3816 R with Rapidaptor quick-release chuck

05071116001		
3816 R	1 x 1/4"x119	
3851/4	1 x PH 1x89; 1 x PH 2x89; 1 x PH 3x89	
3855/4	1 x PZ 1x89; 1 x PZ 2x89; 1 x PZ 3x89	
3867/4 TORX® BO	1 x TX 10 B0x89; 1 x TX 15 B0x89; 1 x TX 20 B0x89; 1 x TX 25 B0x89; 1 x TX 30 B0x89	
3800/4	1 x 1,0x5,5x89	
3840/4 Hex-Plus	1 x 3,0x89; 1 x 4,0x89; 1 x 5,0x89; 1 x 6,0x89	







Kraftform Kompakt 60, imperial, stainless



Pouch with 89 mm bits, stainless steel

17-piece set

1 Kraftform stainless bitholding screwdriver 3816 R with Rapidaptor quick-release chuck

		
05071117001		
	3816 R	1 x 1/4"x119
	3851/4	1 x PH 1x89; 1 x PH 2x89; 1 x PH 3x89
	3867/4 TORX® B0	1 x TX 10 B0x89; 1 x TX 15 B0x89; 1 x TX 20 B0x89; 1 x TX 25 B0x89; 1 x TX 30 B0x89
	3800/4	1 x 1,0x5,5x89
	3840/4 Hex-Plus	1 x 3/32"x89; 1 x 1/8"x89; 1 x 5/32"x89; 1 x 3/16"x89
	3868/4 Square-Plus	1 x # 1x89; 1 x # 2x89; 1 x # 3x89

Tip



Adjustable torque screwdriver



Simple setting of the required torque by hand. Easy-to-read scale value.

Measurement accuracy is $\pm 6\%$ in accordance with the standard EN ISO 6789. Distinctly audible and noticeable excess-load signal when the pre-set torque is reached.



Vacuum ice-hardened



The stainless steel tools from Wera are vacuum ice-hardened and have the hardness and strength needed for screw connections. There are no limitations to the industrial applications they are suitable for.



Kraftform Kompakt 60, 62

Bits of 89 mm in length

Kraftform Kompakt 60



Pouch with 89 mm bits

17-piece set

1 Kraftform bitholding screwdriver 816 R with Rapidaptor quick-release chuck

05059295001		
●	816 R	1 x 1/4"x119
+	851/4 Z PH	1 x PH 1x89; 1 x PH 2x89; 1 x PH 3x89
+	855/4 Z PZ	1 x PZ 1x89; 1 x PZ 2x89; 1 x PZ 3x89
⊕	867/4 Z TORX® BO	1 x TX 10x89; 1 x TX 15x89; 1 x TX 20x89; 1 x TX 25x89; 1 x TX 30x89
⊖	800/4 Z	1 x 1,0x5,5x89
○	840/4 Z Hex-Plus	1 x 3,0x89; 1 x 4,0x89; 1 x 5,0x89; 1 x 6,0x89

Kraftform Kompakt 60, imperial



Pouch with 89 mm bits

17-piece set

1 Kraftform bitholding screwdriver 816 R with Rapidaptor quick-release chuck

05051042001		
●	816 R	1 x 1/4"x119
+	851/4 Z PH	1 x PH 1x89; 1 x PH 2x89; 1 x PH 3x89
⊕	867/4 Z TORX® BO	1 x TX 10x89; 1 x TX 15x89; 1 x TX 20x89; 1 x TX 25x89; 1 x TX 30x89
⊖	800/4 Z	1 x 1,0x5,5x89
○	840/4 Z Hex-Plus	1 x 3/32"x89; 1 x 1/8"x89; 1 x 5/32"x89; 1 x 3/16"x89
◻	868/4 Square-Plus	1 x # 1x89; 1 x # 2x89; 1 x # 3x89

Kraftform Kompakt 60 KK



Pouch with 89 mm bits

17-piece set

1 Kraftform bitholding screwdriver 816 R with Rapidaptor quick-release chuck

05059294001		
●	816 R	1 x 1/4"x119
+	851/4 Z PH	1 x PH 1x89; 1 x PH 2x89; 1 x PH 3x89
+	855/4 Z PZ	1 x PZ 1x89; 1 x PZ 2x89; 1 x PZ 3x89
⊕	867/4 KK	1 x TX 10x89; 1 x TX 15x89; 1 x TX 20x89; 1 x TX 25x89; 1 x TX 30x89; 1 x TX 40x89
○	842/4	1 x 3,0x89; 1 x 4,0x89; 1 x 5,0x89; 1 x 6,0x89

Kraftform Kompakt 62



Pouch with 89 mm bits

33-piece set

1 Kraftform bitholding screwdriver 816 R with Rapidaptor quick-release chuck

05059297001		
●	816 R	1 x 1/4"x119
⊕	857/4 Z Spanner	1 x 4x89; 1 x 6x89; 1 x 8x89; 1 x 10x89
+	851/4 Z PH	1 x PH 1x89; 1 x PH 2x89; 1 x PH 3x89
+	855/4 Z PZ	1 x PZ 1x89; 1 x PZ 2x89; 1 x PZ 3x89
⊕	867/4 Z TORX® BO	1 x TX 8x89; 1 x TX 10x89; 1 x TX 15x89; 1 x TX 20x89; 1 x TX 25x89; 1 x TX 27x89; 1 x TX 30x89; 1 x TX 40x89
⊖	800/4 Z	1 x 1,2x6,5x89
⊕	840/4 Z Hex-Plus BO	1 x 2,0x89; 1 x 2,5x89; 1 x 3,0x89; 1 x 4,0x89; 1 x 5,0x89; 1 x 6,0x89
⊕	871/4 TORQ-SET® Mplus	1 x 6x89; 1 x 8x89; 1 x 10x89
⊕	875/4 TRI-WING®	1 x 1x89; 1 x 2x89; 1 x 3x89; 1 x 4x89

Tip



Ball tip



The spherical drive profile means that it is possible to swivel the axis of the tool to that of the screw, and therefore enable angled, "around-the-corner" screwdriving jobs.

How can time wasted by using the wrong screwdriver be avoided?



Frequently, users have to work with their tools at a fixed workplace location as well as at external sites. Just as frequently, it is only on site that a decision is taken as to whether to work manually or with a power tool.

The Kraftform Kompakt tool sets equip the user for both types of operation with just one single set. Additionally, the sets are kept in belt pouches or plastic cases. This keeps them secure and clean and means that they are clearly arranged for easy tool selection, something that is very practical when they are to be used or transported.







Kraftform Kompakt 70 and 71

Kraftform handle, Rapidaptor and 30 bits

Kraftform Kompakt 70 universal



32-piece set

1 Kraftform bitholding screwdriver 816 R with Rapidaptor quick-release chuck,
1 universal bit holder 889/4/1 K Rapidaptor

05057110001		
●	816 R	1 x 1/4"x119
●○	889/4/1 K	1 x 1/4"x50
+	851/1 TZ PH	3 x PH 1x25; 3 x PH 2x25; 3 x PH 3x25
+	855/1 TZ PZ	3 x PZ 1x25; 3 x PZ 2x25; 3 x PZ 3x25
⊕	867/1 Z TORX® BO	1 x TX 10x25; 1 x TX 15x25; 1 x TX 20x25; 1 x TX 25x25; 1 x TX 30x25; 1 x TX 40x25
⊖	800/1 TZ	1 x 0,6x4,5x25; 1 x 1,0x5,5x25; 1 x 1,2x6,5x25
○	840/1 Z Hex-Plus	1 x 4,0x25; 1 x 5,0x25; 1 x 6,0x25

Kraftform Kompakt 71 security



32-piece set

1 Kraftform bitholding screwdriver 816 R with Rapidaptor quick-release chuck,
1 universal bit holder 889/4/1 K Rapidaptor

05057111001		
●	816 R	1 x 1/4"x119
●○	889/4/1 K	1 x 1/4"x50
⊕	867/1 Z TORX® BO	1 x TX 7x25; 1 x TX 8x25; 1 x TX 9x25; 1 x TX 10x25; 1 x TX 15x25; 1 x TX 20x25; 1 x TX 25x25; 1 x TX 30x25; 1 x TX 40x25
⊖	840/1 Z Hex-Plus BO	1 x 2,0x25; 1 x 2,5x25; 1 x 3,0x25; 1 x 4,0x25; 1 x 5,0x25; 1 x 6,0x25
○	868/1 Z	1 x # 0x25; 1 x # 1x25; 1 x # 2x25; 1 x # 3x25
+	871/1 TORQ-SET® Mplus 25 mm	1 x 6x25; 1 x 8x25; 1 x 10x25; 1 x 1/4"x25
▲	875/1 TRI-WING® 25 mm	1 x 1x25; 1 x 2x25; 1 x 3x25
⊕	857/1 Z Spanner	1 x 4x25; 1 x 6x25; 1 x 8x25; 1 x 10x25





SCHMIDLER
Produktions

Kraftform Kompakt 71
Code No. 60110
EHR

GRÖßE	GRÖßE IN
GRÖßE 1	GRÖßE 12 PH
GRÖßE 2	GRÖßE 12 PH
GRÖßE 3	GRÖßE 12 PH
GRÖßE 4	GRÖßE 12 PH
GRÖßE 5	GRÖßE 12 PH
GRÖßE 6	GRÖßE 12 PH
GRÖßE 7	GRÖßE 12 PH
GRÖßE 8	GRÖßE 12 PH
GRÖßE 9	GRÖßE 12 PH
GRÖßE 10	GRÖßE 12 PH
GRÖßE 11	GRÖßE 12 PH
GRÖßE 12	GRÖßE 12 PH
GRÖßE 13	GRÖßE 12 PH
GRÖßE 14	GRÖßE 12 PH
GRÖßE 15	GRÖßE 12 PH
GRÖßE 16	GRÖßE 12 PH
GRÖßE 17	GRÖßE 12 PH
GRÖßE 18	GRÖßE 12 PH
GRÖßE 19	GRÖßE 12 PH
GRÖßE 20	GRÖßE 12 PH
GRÖßE 21	GRÖßE 12 PH
GRÖßE 22	GRÖßE 12 PH
GRÖßE 23	GRÖßE 12 PH
GRÖßE 24	GRÖßE 12 PH
GRÖßE 25	GRÖßE 12 PH
GRÖßE 26	GRÖßE 12 PH
GRÖßE 27	GRÖßE 12 PH
GRÖßE 28	GRÖßE 12 PH
GRÖßE 29	GRÖßE 12 PH
GRÖßE 30	GRÖßE 12 PH
GRÖßE 31	GRÖßE 12 PH
GRÖßE 32	GRÖßE 12 PH
GRÖßE 33	GRÖßE 12 PH
GRÖßE 34	GRÖßE 12 PH
GRÖßE 35	GRÖßE 12 PH
GRÖßE 36	GRÖßE 12 PH
GRÖßE 37	GRÖßE 12 PH
GRÖßE 38	GRÖßE 12 PH
GRÖßE 39	GRÖßE 12 PH
GRÖßE 40	GRÖßE 12 PH
GRÖßE 41	GRÖßE 12 PH
GRÖßE 42	GRÖßE 12 PH
GRÖßE 43	GRÖßE 12 PH
GRÖßE 44	GRÖßE 12 PH
GRÖßE 45	GRÖßE 12 PH
GRÖßE 46	GRÖßE 12 PH
GRÖßE 47	GRÖßE 12 PH
GRÖßE 48	GRÖßE 12 PH
GRÖßE 49	GRÖßE 12 PH
GRÖßE 50	GRÖßE 12 PH
GRÖßE 51	GRÖßE 12 PH
GRÖßE 52	GRÖßE 12 PH
GRÖßE 53	GRÖßE 12 PH
GRÖßE 54	GRÖßE 12 PH
GRÖßE 55	GRÖßE 12 PH
GRÖßE 56	GRÖßE 12 PH
GRÖßE 57	GRÖßE 12 PH
GRÖßE 58	GRÖßE 12 PH
GRÖßE 59	GRÖßE 12 PH
GRÖßE 60	GRÖßE 12 PH
GRÖßE 61	GRÖßE 12 PH
GRÖßE 62	GRÖßE 12 PH
GRÖßE 63	GRÖßE 12 PH
GRÖßE 64	GRÖßE 12 PH
GRÖßE 65	GRÖßE 12 PH
GRÖßE 66	GRÖßE 12 PH
GRÖßE 67	GRÖßE 12 PH
GRÖßE 68	GRÖßE 12 PH
GRÖßE 69	GRÖßE 12 PH
GRÖßE 70	GRÖßE 12 PH
GRÖßE 71	GRÖßE 12 PH
GRÖßE 72	GRÖßE 12 PH
GRÖßE 73	GRÖßE 12 PH
GRÖßE 74	GRÖßE 12 PH
GRÖßE 75	GRÖßE 12 PH
GRÖßE 76	GRÖßE 12 PH
GRÖßE 77	GRÖßE 12 PH
GRÖßE 78	GRÖßE 12 PH
GRÖßE 79	GRÖßE 12 PH
GRÖßE 80	GRÖßE 12 PH
GRÖßE 81	GRÖßE 12 PH
GRÖßE 82	GRÖßE 12 PH
GRÖßE 83	GRÖßE 12 PH
GRÖßE 84	GRÖßE 12 PH
GRÖßE 85	GRÖßE 12 PH
GRÖßE 86	GRÖßE 12 PH
GRÖßE 87	GRÖßE 12 PH
GRÖßE 88	GRÖßE 12 PH
GRÖßE 89	GRÖßE 12 PH
GRÖßE 90	GRÖßE 12 PH
GRÖßE 91	GRÖßE 12 PH
GRÖßE 92	GRÖßE 12 PH
GRÖßE 93	GRÖßE 12 PH
GRÖßE 94	GRÖßE 12 PH
GRÖßE 95	GRÖßE 12 PH
GRÖßE 96	GRÖßE 12 PH
GRÖßE 97	GRÖßE 12 PH
GRÖßE 98	GRÖßE 12 PH
GRÖßE 99	GRÖßE 12 PH
GRÖßE 100	GRÖßE 12 PH

GRÖßE 101
GRÖßE 102
GRÖßE 103
GRÖßE 104
GRÖßE 105
GRÖßE 106
GRÖßE 107
GRÖßE 108
GRÖßE 109
GRÖßE 110
GRÖßE 111
GRÖßE 112
GRÖßE 113
GRÖßE 114
GRÖßE 115
GRÖßE 116
GRÖßE 117
GRÖßE 118
GRÖßE 119
GRÖßE 120
GRÖßE 121
GRÖßE 122
GRÖßE 123
GRÖßE 124
GRÖßE 125
GRÖßE 126
GRÖßE 127
GRÖßE 128
GRÖßE 129
GRÖßE 130
GRÖßE 131
GRÖßE 132
GRÖßE 133
GRÖßE 134
GRÖßE 135
GRÖßE 136
GRÖßE 137
GRÖßE 138
GRÖßE 139
GRÖßE 140
GRÖßE 141
GRÖßE 142
GRÖßE 143
GRÖßE 144
GRÖßE 145
GRÖßE 146
GRÖßE 147
GRÖßE 148
GRÖßE 149
GRÖßE 150
GRÖßE 151
GRÖßE 152
GRÖßE 153
GRÖßE 154
GRÖßE 155
GRÖßE 156
GRÖßE 157
GRÖßE 158
GRÖßE 159
GRÖßE 160
GRÖßE 161
GRÖßE 162
GRÖßE 163
GRÖßE 164
GRÖßE 165
GRÖßE 166
GRÖßE 167
GRÖßE 168
GRÖßE 169
GRÖßE 170
GRÖßE 171
GRÖßE 172
GRÖßE 173
GRÖßE 174
GRÖßE 175
GRÖßE 176
GRÖßE 177
GRÖßE 178
GRÖßE 179
GRÖßE 180
GRÖßE 181
GRÖßE 182
GRÖßE 183
GRÖßE 184
GRÖßE 185
GRÖßE 186
GRÖßE 187
GRÖßE 188
GRÖßE 189
GRÖßE 190
GRÖßE 191
GRÖßE 192
GRÖßE 193
GRÖßE 194
GRÖßE 195
GRÖßE 196
GRÖßE 197
GRÖßE 198
GRÖßE 199
GRÖßE 200

Metax
5 R
62



Kraftform Kompakt 100

Bits, Bit Holders and L-keys in one tool set

Kraftform Kompakt 100



52-piece set; in a surface-preserving, compact and extremely robust textile box; low volume and weight for simplified mobility.
 Compact tool set with 52 screwdriving tools. 1 hand holder Rapidaptor with quick-release chuck; 1 bit holder Rapidaptor with quick-release chuck; 30 BiTorsion bits (25 mm length) for long service life, tough (BTZ), for universal use, extra-hard (BTH), 12 Impaktor bits (50 mm length) for an above-average service life even under extreme conditions, 8 L-keys with Hex-Plus profile (reduces the notching effect that is damaging for the head of the screw) ball-end on long arm; extremely robust textile box, extremely robust, for long service life, can be stored in a spacesaving upright position; textile material for surface protection.

05057460001	
●	813 R 1 x 1/4"x90
●○	889/4/1 K 1 x 1/4"x50
+	851/1 BTZ PH 2 x PH 1x25; 4 x PH 2x25; 2 x PH 3x25
+	851/4 IMP DC 2 x PH 2x50; 1 x PH 3x50
+	855/1 BTH PZ 2 x PZ 1x25; 4 x PZ 2x25; 2 x PZ 3x25
+	855/4 IMP DC 2 x PZ 2x50; 1 x PZ 3x50
⊕	867/1 TORX® 2 x TX 10x25; 2 x TX 15x25; 3 x TX 20x25; BTZ 2 x TX 25x25; 2 x TX 30x25; 1 x TX 40x25
⊕	867/4 IMP DC 1 x TX 25x50; 1 x TX 30x50; 1 x TX 40x50
●	800/1 BTZ 1 x 0,8x5,5x25; 1 x 1,0x5,5x25
○	840/4 IMP DC 1 x 4,0x50; 1 x 5,0x50; 1 x 6,0x50
○	950 PKS 1 x 1,5x50 ¹⁾ ; 1 x 2,0x56; 1 x 2,5x63; 1 x 3,0x71; 1 x 4,0x80; 1 x 5,0x90; 1 x 6,0x100; 1 x 8,0x112

¹⁾ Regular hexagon



Kraftform Kompakt user-specific sets

Kraftform Kompakt W 1 Maintenance

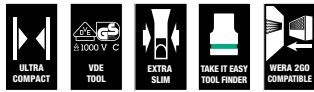

35-piece set; in surface-protecting, compact textile box, highly robust; low volume and weight for simplified mobility.

Compact tool set with the most important screwdriving tools for maintenance jobs both indoors as well as outdoors. VDE hand holder including 12 VDE blades; 1 Joker double open-ended wrench with holding function, limit stop, small return angle and extremely high-grip toothing; incl. the incredibly fast $\frac{1}{4}$ " Zyklop Speed ratchet with accessories; 8 manual and power tool sockets in the dimensions 5.5-13, 1 universal bit holder; 7 25mm bits; 1 screw gripper to firmly hold screws; 1 voltage tester 247; textile box that is very robust and durable; can be positioned upright in the workshop shelf for tidy storage; additional surface protection thanks to the textile outer material; low weight and volume for simplified mobility.

05135926001		
●	817 VDE	1 x 9x102
●	KK 60 i	1 x 0,4x2,5x154
●	KK 60 iS	1 x 0,6x3,5x154; 1 x 0,8x4,0x154; 1 x 1,0x5,5x154
+	KK 62 iS	1 x PH 1x154; 1 x PH 2x154
+	KK 65 iS PZ	1 x PZ 1x154; 1 x PZ 2x154
+	KK 67 i TORX®	1 x TX 10x154
+	KK 67 iS TORX®	1 x TX 15x154; 1 x TX 20x154; 1 x TX 25x154
	1440	1 x 4,5 - 6,0x41,0
●	247	1 x 0,5x3,0x70
	Joker Double	1 x 10x13x167
○	8000 A	1 x 1/4"x152,0
●	8784 A1	1 x 1/4"x1/4"x37,0
●	8794 SA	1 x 1/4"x75,0
●	8790 HMA	1 x 5,5x23,0; 1 x 6,0x23,0; 1 x 7,0x23,0; 1 x 8,0x23,0; 1 x 10,0x23,0; 1 x 11,0x23,0; 1 x 12,0x23,0; 1 x 13,0x23,0
●	893/4/1 K	1 x 1/4"x50
+	855/1 Z PZ	1 x PZ 1x25; 1 x PZ 2x25
○	840/1 Z Hex-Plus	1 x 3,0x25; 1 x 4,0x25; 1 x 5,0x25; 1 x 6,0x25
+	867/1 Z TORX®	1 x TX 25x25

Product not available in the USA and Canada.

Kraftform Kompakt H 1 Woodcraft



41-piece set; in surface-protecting, compact textile box, highly robust; low volume and weight for simplified mobility.

Compact tool set with the 41 most important screwdriving tools for jobs involving wood: including the robust Bit Ratchet Zyklop Mini with extension and socket adaptor; 8 manual and power tool sockets in the dimensions 5.5-13; 1 hand holder 816 RA with ratchet function, fine toothing for small return angle, switch-over ring (right, fixed, left), maximum torque 50 Nm and bit take-up with Rapidaptor technology; 1 universal bit holder; 6 bits of 25mm in length; 16 bits of 89 mm in length; 5 twist drill bits for wood with a diameter of 3-8mm; 1 screw gripper to firmly hold screws; 1 voltage tester 247.

05135939001		
●	816 RA	1 x 1/4"x142,0
	8001 A	1 x 1/4"x87,0
○	870/1	1 x 1/4"x25
●	8794 SA	1 x 1/4"x75,0
●	8790 HMA	1 x 5,5x23,0; 1 x 6,0x23,0; 1 x 7,0x23,0; 1 x 8,0x23,0; 1 x 10,0x23,0; 1 x 12,0x23,0; 1 x 13,0x23,0
●	893/4/1 K	1 x 1/4"x50
+	851/4 Z PH	1 x PH 1x89; 1 x PH 2x89; 1 x PH 3x89
+	855/4 Z PZ	1 x PZ 1x89; 1 x PZ 2x89; 1 x PZ 3x89
+	855/1 Z PZ	1 x PZ 1x25; 1 x PZ 2x25; 1 x PZ 3x25
+	867/4 Z TORX®	1 x TX 10x89; 1 x TX 15x89; 1 x TX 20x89; 1 x TX 25x89; 1 x TX 30x89
+	867/1 Z TORX®	1 x TX 20x25; 1 x TX 25x25
○	840/4 Z Hex-Plus	1 x 3,0x89; 1 x 4,0x89; 1 x 5,0x89; 1 x 6,0x89
●	800/4 Z	1 x 1,0x5,5x89
●	800/1 Z	1 x 1,0x5,5x25
+	849 HSS	1 x 3,0x70,0; 1 x 4,0x74,0; 1 x 5,0x85,0; 1 x 6,0x95,0; 1 x 8,0x110,0
●	247	1 x 0,5x3,0x70
	1441	1 x 4,5 - 6,0x41,0

Product not available in the USA and Canada.

Kraftform Kompakt M 1 Metal



39-piece set; in surface-protecting, compact textile box, highly robust; low volume and weight for simplified mobility.

Compact tool set with the 39 most important screwdriving tools for jobs involving metal, including the incredibly fast $\frac{1}{4}$ " Zyklop Speed ratchet with accessories; 7 manual and power tool sockets in the dimensions 5.5-13; 1 bit hand holder; 13 bits of 89 mm in length; 6 combination screw tap bits; 6 twist drill bits for metal with a diameter of 3-10mm; 1 screw gripper to firmly hold screws; 1 voltage tester 247; textile box that is very robust and durable; can be positioned upright in the workshop shelf for tidy storage; additional surface protection thanks to the textile outer material; low weight and volume for simplified mobility.

05135928001		
⊕	8000 A	1 x 1/4"x152,0
⊕	8794 LA	1 x 1/4"x150,0
⊕	8794 A	1 x 1/4"x56,0
⊕	8784 A1	1 x 1/4"x1/4"x37,0
⊕	816 R	1 x 1/4"x119
⊕	8790 HMA	1 x 5,5x23,0; 1 x 6,0x23,0; 1 x 7,0x23,0; 1 x 8,0x23,0; 1 x 10,0x23,0; 1 x 12,0x23,0; 1 x 13,0x23,0
⊕	851/4 Z PH	1 x PH 1x89; 1 x PH 2x89; 1 x PH 3x89
⊕	840/4 Z Hex-Plus	1 x 3,0x89; 1 x 4,0x89; 1 x 5,0x89; 1 x 6,0x89
⊕	867/4 Z TORX®	1 x TX 10x89; 1 x TX 15x89; 1 x TX 20x89; 1 x TX 25x89; 1 x TX 30x89
⊕	800/4 Z	1 x 1,0x5,5x89
⊕	847 HSS	1 x 2,5x36,0; 1 x 3,3x39,0; 1 x 4,2x41,0; 1 x 5,0x44,0; 1 x 6,8x51,0; 1 x 8,5x59,0
⊕	848 HSS	1 x 3,0x38,0; 1 x 4,0x44,0; 1 x 5,0x50,0; 1 x 6,0x50,0; 1 x 8,0x51,0; 1 x 10,0x54,0
	1441	1 x 4,5 - 6,0x41,0
⊕	247	1 x 0,5x3,0x70

Product not available in the USA and Canada.

Tip

Kraftform Kompakt H1 Woodcraft



Compact tool set with the 41 most important screwdriving tools for jobs involving wood.

Kraftform Kompakt W1 Maintenance

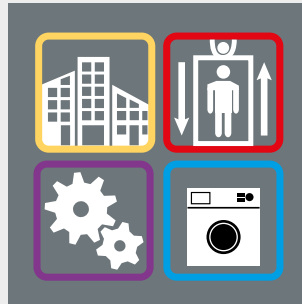

The perfect set for diverse maintenance jobs both indoors as well as outdoors - applications: electronics, mechatronics, building technology, photovoltaic etc. etc.

Kraftform Kompakt M1 Metal



Compact tool set with the 39 most important screwdriving tools for jobs involving metal.















Kraftform Kompakt user-specific sets

Kraftform Kompakt SH 1 PlumbKit



2 Joker combination ratchet wrenches with special retaining plate to prevent slipping/loss of the screw and more power transfer, 1 Zyklop ratchet 8000 A (1/4") for rapid, powerful operation, 3 Zyklop sockets 8790 HMA for manual and power tool applications, 1 Zyklop adapter 8784 A1 for bits, 6 TORX® HF bits 867/4 with holding function for TORX® screws for secure hold without any loss of the screw, 1 voltage tester 247, 2 Kraftform Series 100 VDE slotted screwdrivers 160 i and 160 iS for safe work up to 1,000 volts (160 iS has a reduced blade diameter with integrated protective insulation to allow sunken screw and spring elements to be reached and actuated) with "Take it easy" tool finder: colour coding according to profile and size stamp, 1 Kraftform chisel driver 932 A (slotted) with hexagon blade throughout and integrated impact cap for screwdriving and simple chiselling jobs, 2 socket wrench screwdrivers 395 HO with hollow shaft for the tightening or loosening of screws on long bolts as well as for jammed screws.

		
05135927001		
	Joker	1 x 10x159; 1 x 13x177
	8000 A	1 x 1/4"x152,0
	8790 HMA	1 x 7,0x23,0; 1 x 10,0x23,0; 1 x 13,0x23,0
	8784 A1	1 x 1/4"x1/4"x37,0
	867/4 TORX® HF	1 x TX 10x50; 1 x TX 15x50; 1 x TX 20x50; 1 x TX 25x50; 1 x TX 30x50; 1 x TX 40x50
	851/4 Z PH	1 x PH 1x89; 1 x PH 2x89
	840/4 Z Hex-Plus	1 x 3,0x89; 1 x 4,0x89; 1 x 5,0x89; 1 x 6,0x89
	247	1 x 0,5x3,0x70
	160 iS	1 x 0,6x3,5x100
	160 i VDE	1 x 1,0x5,5x125
	932 A	1 x 1,2x7,0x125
	395 HO	1 x 10,0x90; 1 x 13,0x90

^{*)} Product not available in the USA and Canada.



Bitholding Screwdrivers and Adaptors

Suitable for hand and power tool applications

3816 R Bit-holding screwdriver with Rapidaptor quick-release chuck, stainless



Application: Suitable for 1/4" hexagon insert bits, DIN ISO 1173-C 6,3 and E 6,3 and Wera Series 1 and 4

Drive: 1/4" hexagon with Rapidaptor rapid-in, rapid-out, rapid-spin, chuck-all and single-hand technology

Handle: Kraftform with non-roll feature, multi-component

		mm
05051465001	1/4"	119

816 R Bitholding screwdriver with Rapidaptor quick-release chuck



Application: Suitable for 1/4" DIN ISO 1173-C 6,3 and E 6,3 hexagon insert bits and Wera Series 1 and 4

Drive: 1/4" hexagon with Rapidaptor rapid-in, rapid-out, rapid-spin, chuck-all and single-hand technology, magnetic

Handle: Kraftform with non-roll feature, multi-component

		mm
05051462001	1/4"	119

813 R Bitholding screwdriver with Rapidaptor quick-release chuck



Application: Suitable for 1/4" DIN ISO 1173-C 6,3 and E 6,3 hexagon insert bits and Wera Series 1 and 4

Drive: 1/4" hexagon with Rapidaptor rapid-in, rapid-out, rapid-spin, chuck-all and single-hand technology, magnetic

Handle: Kraftform with non-roll feature, multi-component

		mm
05051272001	1/4"	90

816 R SB Bitholding screwdriver with Rapidaptor quick-release chuck

05073540001	4013288
	106032
	1 x 1/4"x119

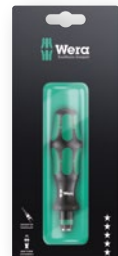

489 R T-handle Rapidaptor



Application: Suitable for 1/4" DIN ISO 1173-C 6,3 and E 6,3 hexagon insert bits and Wera Series 1 and 4

Drive: 1/4" hexagon with Rapidaptor rapid-in, rapid-out, rapid-spin, chuck-all and single-hand technology, magnetic

Handle: T-handle, multi-component

		mm	mm	mm		
05013390001	1/4"	45	44	87	1 25/32"	



Rapidaptor

817 R Bitholding screwdriver with Rapidaptor quick-release chuck



Application: Suitable for 1/4" DIN ISO 1173-C 6.3 and E 6,3 hexagon insert bits and Wera Series 1 and 4

Drive: 2 position telescopic blade, can be retracted into the handle for confined space operation or extended for more reach, can also be removed and used as a 100mm bit holder in the power tool, 1/4" hexagon suitable for power tools with DIN ISO 1173-F 6.3 chuck

Design: 1/4" hexagon with Rapidaptor rapid-in, rapid-out, rapid-spin, chuck-all and single-hand technology, magnetic

Handle: Kraftform with non-roll feature, multi-component

		mm
05051482001	1/4"	133

817 R SB Bitholding screwdriver with Rapidaptor quick-release chuck



4013288

05073541001

1 x 1/4"x133

106025



Rapid-in and self-lock



The bit can be pushed into the adaptor without moving the sleeve. The lock is activated automatically as soon as the bit is applied to the screw. Bits are held securely and wobble-free.

Rapid-out

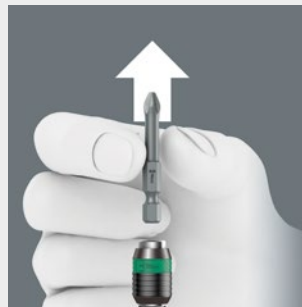

Simply push the sleeve forward to change the bit. The spring mechanism lifts the bit off the magnet and unlocks the tool. The bit can be easily removed. The rapid-out function makes it easy to remove even the smallest bits without extra tools.

Chuck-all

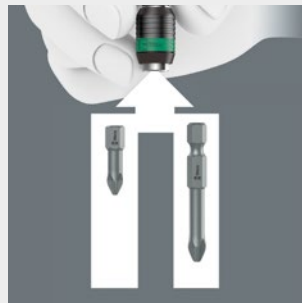

The Rapidaptor quick-release chucks hold 1/4" DIN ISO 1173-C 6,3 and E 6,3 as well as Wera series 1 and 4 bits.

Single-hand function



Every function of the Rapidaptor quick-release chuck, such as inserting or releasing bits, can be carried out with one hand. This is faster, more economical and more ergonomic. There are no unnecessary manoeuvres.



Bitholding Screwdrivers and Adaptors

Suitable for hand and power tool applications

820/1/6 Combination screwdriver with strong permanent magnet and bits



Application: Suitable for 1/4" DIN ISO 1173-C 6,3 hexagon insert bits and Wera Series 1

Blade: Hexagon

Design: Strong permanent magnet

Handle: Kraftform, single-component, rotary magazine

05051620001	
	819/1 Vario 1 x 1/4"x120
	867/1 Z TORX® 1 x TX 10x25; 1 x TX 15x25; 1 x TX 20x25; 1 x TX 25x25; 1 x TX 30x25; 1 x TX 40x25

819/1/6 PH Combined Screwdriver with strong permanent magnet and bits



Application: Suitable for 1/4" DIN ISO 1173-C 6,3 hexagon insert bits and Wera Series 1

Blade: Hexagon

Design: With strong permanent magnet

Handle: Kraftform, one component, rotary magazine

05346280001	
	819/1 Vario 1 x 1/4"x120
	851/1 Z PH 1 x PH 1x25; 1 x PH 2x25; 1 x PH 3x25
	800/1 Z 1 x 0,6x4,5x25; 1 x 1,0x5,5x25; 1 x 1,2x6,5x25

819/1/6 Combination screwdriver with strong permanent magnet and bits



Application: Suitable for 1/4" DIN ISO 1173-C 6,3 hexagon insert bits and Wera Series 1

Blade: Hexagon

Design: Strong permanent magnet

Handle: Kraftform, single-component, rotary magazine

05051615001	
	819/1 Vario 1 x 1/4"x120
	851/1 Z PH 1 x PH 1x25; 1 x PH 2x25
	855/1 Z PZ 1 x PZ 1x25; 1 x PZ 2x25
	800/1 Z 1 x 0,8x5,5x25; 1 x 1,2x6,5x25

819/1 Combination screwdriver with strong permanent magnet, without bits



Application: Suitable for 1/4" DIN ISO 1173-C 6,3 hexagon insert bits and Wera Series 1

Blade: Hexagon

Design: Strong permanent magnet

Handle: Kraftform, single-component, rotary magazine

		mm	mm	mm	
05051610001	1/4"	120	110	10,5	4 3/4"





392 Bitholding screwdriver with flexible shaft



Application: Suitable for 1/4" DIN ISO 1173-C 6,3 hexagon bits and Wera Series 1

Design: Wera quick-release chuck

Handle: Kraftform with non-roll feature, multi-component

		 mm	 mm	 "
05028160001	1/4"	177	98	7"



813 Bitholding screwdriver



Application: Suitable for 1/4" DIN ISO 1173-C 6,3 hexagon insert bits and Wera Series 1

Drive: 1/4" hexagon, magnetic

Handle: Kraftform with non-roll feature, multi-component

		 mm	 mm
05051274001	1/4"	78	68

812/1 Bitholding screwdriver with strong permanent magnet







Application: Suitable for 1/4" DIN ISO 1173-C 6,3 hexagon insert bits and Wera Series 1

Blade: Hexagon

Design: Strong permanent magnet, chrome-plated

Handle: Kraftform with non-roll feature, multi-component

		 mm	 mm	 mm	 "
05051205001	1/4"	120	112	10,5	4 3/4"

811/1 Stubby







Application: Suitable for 1/4" DIN ISO 1173-C 6,3 hexagon insert bits and Wera Series 1

Blade: Round

Design: Extra short with strong permanent magnet

Handle: Kraftform, single-component

		 mm	 mm	 "
05051105001	1/4"	10	54	3/8"

810/1 Bitholding screwdriver with retaining ring







Application: Suitable for 1/4" DIN ISO 1173-C 6,3 hexagon insert bits and Wera Series 1

Blade: Hexagon

Design: Retaining ring, chrome-plated

Handle: Kraftform with non-roll feature, multi-component

		 mm	 mm	 mm	 "
05051005001	1/4"	120	112	10,5	4 3/4"

Kraftform Kompakt Vario

With Ratchet Function

Kraftform Kompakt 60 RA



Pouch with 89 mm bits

17-piece set

1 hand-held bit holder 816 RA Kraftform with ratchet function, fine-tooth design for minimal return angle, switchover ring (right, locked, left), maximum torque of up to 50 Newton metres, 1/4" hexagon chuck with Rapidaptor technology i.e. rapid-in, rapid-out, rapid-spin, chuck-all and single-hand function for rapid bit change, magnetic and 16 bits of 89 mm in length suitable for holders as per DIN ISO 1173-F 6,3 or for direct insertion in a power tool

05051040001		
●	816 RA	1 x 1/4"x142,0
⊕	851/4 Z PH	1 x PH 1x89; 1 x PH 2x89; 1 x PH 3x89
⊕	855/4 Z PZ	1 x PZ 1x89; 1 x PZ 2x89; 1 x PZ 3x89
⊕	867/4 Z TORX® BO	1 x TX 10x89; 1 x TX 15x89; 1 x TX 20x89; 1 x TX 25x89; 1 x TX 30x89
●	800/4 Z	1 x 1,0x5,5x89
○	840/4 Z Hex-Plus	1 x 3,0x89; 1 x 4,0x89; 1 x 5,0x89; 1 x 6,0x89

Kraftform Kompakt 60 RA, imperial



Pouch with 89 mm bits

17-piece set

1 hand-held bit holder 816 RA Kraftform with ratchet function, fine-tooth design for minimal return angle, switchover ring (right, locked, left), maximum torque of up to 50 Newton metres, 1/4" hexagon chuck with Rapidaptor technology i.e. rapid-in, rapid-out, rapid-spin, chuck-all and single-hand function for rapid bit change, magnetic and 16 bits of 89 mm in length suitable for holders as per DIN ISO 1173-F 6,3 or for direct insertion in a power tool

05051041001		
●	816 RA	1 x 1/4"x142,0
⊕	851/4 Z PH	1 x PH 1x89; 1 x PH 2x89; 1 x PH 3x89
⊕	867/4 Z TORX® BO	1 x TX 10x89; 1 x TX 15x89; 1 x TX 20x89; 1 x TX 25x89; 1 x TX 30x89
●	800/4 Z	1 x 1,0x5,5x89
○	840/4 Z Hex-Plus	1 x 3/32"x89; 1 x 1/8"x89; 1 x 5/32"x89; 1 x 3/16"x89
○	868/4 Square-Plus	1 x # 1x89; 1 x # 2x89; 1 x # 3x89

816 RA Ratchet screwdriver



Application: Suitable for hexagon socket insert bits as per DIN ISO 1173-C 6,3 and E 6,3 and Wera series 1 and 4

Design: Ratchet, fine-tooth design for minimal return angle, switchover ring (right, locked, left), maximum torque of up to 50 Newton metres, 1/4" hexagon chuck with Rapidaptor technology i.e. rapid-in, rapid-out, rapid-spin, chuck-all and single-hand function for rapid bit change, magnetic

Handle: Kraftform with non-roll feature, multi-component

	○	8,1
		mm
05051461001	1/4"	142,0



80 RA Vario ratchet screwdriver



Application: Suitable for 6 mm Wera Vario blades

Design: Ratchet, fine-tooth design for minimal return angle, switchover ring (right, locked, left), maximum torque of up to 50 Newton metres, 6 mm hexagon chuck

Handle: Kraffform with non-roll feature, multi-component







		
	mm	mm
05002901001	6	115,0

Kraffform Kompakt Vario RA SB



Pouch with 175 mm Wera Vario double-ended blades, 6 mm hexagon shaft
7-piece set

1 Kraffform Kompakt Vario RA hand-held bit holder with ratchet function, fine-tooth design for minimal return angle, switchover ring (right, fixed, left), maximum torque of up to 50 Newton meters, 6 mm hexagon chuck for Wera Vario double-ended blades, 6 Vario double-ended blades (= 12 different dimensions)

		
05073665001		
	80 RA	1 x 6x115,0
	85	1 x PH 1xPH 2x175
	86	1 x PZ 1xPZ 2x175
	87	1 x TX 10xTX 15x175; 1 x TX 20xTX 25x175
	81	1 x 0,6x4,0x1,0x6,0x175
	84 ¹⁾	1 x 4x5x175

¹⁾ without ball-end

Tip

Fine-tooth design

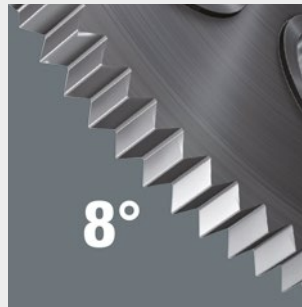

Fine action 44 tooth system for precision work. Great time savings when screwdriving.

Reverse direction switch

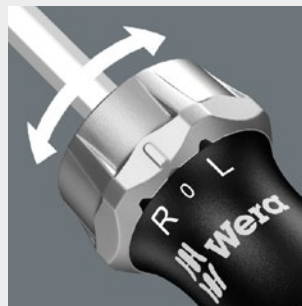

Ergonomic design of the reverse direction switch.

Fine adjustment work



Additionally, the lockable neutral position permits exact adjustment work without having to change the screwdriving direction every time. Lockable neutral position for fine adjustment work.

Kraffform Kompakt Vario RA SB

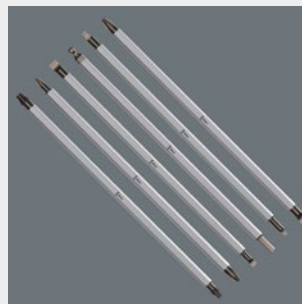

The 6 mm double-ended blades of 175 mm length are out of high quality bit material which gives them a particularly long service life.

Kraftform Kompakt Vario

With Ratchet Function

Kraftform Kompakt Pistol RA



7-piece set

1 hand-held bit holder 814 RA Kraftform, integrated Magazine, with ratchet function, fine-tooth design for minimal return angle, switchover ring (right, locked, left), maximum torque of up to 50 Newton metres, 1/4" hexagon chuck with Rapidaptor technology i.e. rapid-in, rapid-out, rapid-spin, chuck-all and single-hand function for rapid bit change, magnetic and 6 bits of 25 mm in length suitable for holders as per DIN ISO 1173-D 6,3

Holster

05051030001	
+	814 RA 1 x 1/4"
+	851/1 Z PH 1 x PH 1x25; 1 x PH 2x25
+	855/1 Z PZ 1 x PZ 1x25; 1 x PZ 2x25
+	867/1 TORX® 1 x TX 20x25; 1 x TX 25x25

Kraftform Kompakt Pistol RA 4



13-piece set

1 hand-held bit holder 814 RA Kraftform, integrated Magazine, with ratchet function, fine-tooth design for minimal return angle, switchover ring (right, locked, left), maximum torque of up to 50 Newton metres, 1/4" hexagon chuck with Rapidaptor technology i.e. rapid-in, rapid-out, rapid-spin, chuck-all and single-hand function for rapid bit change, magnetic, 6 bits of 25 mm in length suitable for holders as per DIN ISO 1173-D 6.3 and 6 bits of 89 mm in length suitable for holders as per DIN ISO 1173-F 6.3

Holster

05051031001	
	814 RA 1 x 1/4"
+	851/1 BTZ PH 1 x PH 1x25; 1 x PH 2x25
+	855/1 BTZ PZ 1 x PZ 1x25; 1 x PZ 2x25
+	867/1 TORX® 1 x TX 20x25; 1 x TX 25x25
	BTZ
+	851/4 Z PH 1 x PH 1x89; 1 x PH 2x89
+	855/4 Z PZ 1 x PZ 1x89; 1 x PZ 2x89
+	867/4 Z TORX® 1 x TX 20x89; 1 x TX 25x89

Kraftform Kompakt 27 RA 1 SB



Application: Suitable for hexagon socket insert bits as per DIN ISO 1173-C 6,3 and Wera series 1

Design: Ratchet, fine-tooth design for minimal return angle, switchover ring (right, locked, left), maximum torque of up to 50 Newton metres, hexagon blade with 1/4" hexagon chuck, stainless steel sleeve, strong permanent magnet

Handle: Kraftform with non-roll feature, multi-component, integrated magazine

05073660001	
+	851/1 Z PH 1 x PH 1x25; 1 x PH 2x25
+	855/1 Z PZ 1 x PZ 1x25; 1 x PZ 2x25
+	800/1 Z 1 x 1,0x5,5x25; 1 x 1,2x6,5x25

Kraftform Kompakt 27 RA 2 SB



Application: Suitable for hexagon socket insert bits as per DIN ISO 1173-C 6,3 and Wera series 1

Design: Ratchet, fine tooth system for minimal return angle, switchover ring (clockwise, locked, anticlockwise), maximum torque of up to 50 Newton metres, hexagon blade with 1/4" hexagon chuck, stainless steel sleeve, strong permanent magnet

Handle: Kraftform with non-roll feature, multi-component, integrated magazine for 6 bits (25 mm)

05073661002	
+	851/1 Z PH 1 x PH 1x25; 1 x PH 2x25
+	800/1 Z 1 x 1,0x5,5x25; 1 x 1,2x6,5x25
+	868/1 Z 1 x # 1x25; 1 x # 2x25



Kraftform Kompakt Vario

Without Ratchet Function

88/1 Vario set



11-piece set, specifically for demanding workshop environments

Icon	Part No.	Description
●	80	1 x 6x98
⊕	85	1 x PH 1xPH 2x175
⊕	86	1 x PZ 1xPZ 2x175
⊗	87	1 x TX 10xTX 15x175; 1 x TX 20xTX 25x175; 1 x TX 30xTX 40x175
⊖	81	1 x 0,6x4,0x1,0x6,0x175; 1 x 0,8x5,0x1,2x7,0x175
○	84	1 x 4x4x175; 1 x 5x5x175; 1 x 6x6x175

80 Vario handle



Application: 6 mm Vario blades and adaptors

Handle: Kraftform with non-roll feature, multi-component, 10 mm bolster

Icon	mm	mm	mm
0500290001	6	10	98

95 Vario T-handle



Application: 6 mm Vario blades and adaptors

Handle: T-handle, single-component

Icon	mm	mm	mm	mm
05003265001	6	56	44	2 1/4"

830 Vario bit holder adaptor



Application: Suitable for 1/4" DIN ISO 1173-C 6,3 hexagon insert bits and Wera Series 1

Blade: 6 mm hexagon, chrome-plated

Drive: Wera 1/4" quick-release chuck with strong permanent magnet

Icon	mm	mm	mm	mm
05051835001	1/4"	6	165	6 9/16"

91 Vario extension



Application: Vario blades and adaptors

Blade: 6 mm hexagon, chrome-plated

Drive: 6 mm hexagon socket

Icon	mm	mm	mm	mm
05003210001	6	6	175	7"





712 Vario socket adaptor



Application: Suitable for 1/4" square drive sockets

Blade: 6 mm hexagon, chrome-plated

Drive: 1/4" square head

		 mm	 mm	 mm
05040001001	1/4"	6	175	7"







81 Combination blade for slotted screws



Application: Slotted screws

Blade: 6 mm hexagon

Design: Chrome-plated, Black Point

	 mm	 mm	 mm	 mm	 mm	 mm	 mm
05002910001	0,6	4,0	1,0	6,0	6	175	7"
05002913001	0,8	5,0	1,2	7,0	6	175	7"







82 Combination blade for slotted/Phillips screws



Application: Slotted screws and Phillips screws

Blade: 6 mm hexagon

Design: Chrome-plated, Black Point

		 mm	 mm	 mm	 mm	 mm
05002920001	PH 1	0,6	4,0	6	175	7"
05002923001	PH 2	1,0	6,0	6	175	7"
05002926001	PH 3	1,2	7,0	6	175	7"

Tip

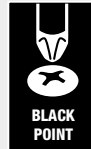

Black Point Tip



The Wera Black Point tip provides an exact fit with optimum corrosion protection.

High quality bit material

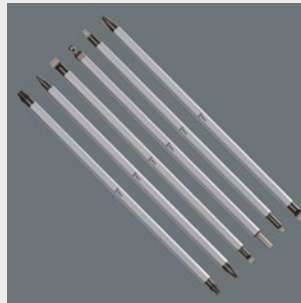

The 6 mm double-ended blades of 175 mm length are out of high quality bit material which gives them a particularly long service life.

Adaptor



1/4" hexagon and square drives as per DIN ISO 1173-C 6,3 and DIN 3120 can also be driven with the 6 mm handles by attaching an adaptor.



Kraftform Kompakt Vario

Without Ratchet Function

83 Combination blade for Phillips/Pozidriv screws



Application: Phillips screws and Pozidriv screws

Blade: 6 mm hexagon

Design: Chrome-plated, Black Point

			mm	mm	
05002930001	PH 1	PZ 1	6	175	7"
05002933001	PH 2	PZ 2	6	175	7"

86 Combination blade for Pozidriv screws



Application: Suitable for Pozidriv screws

Blade: 6 mm hexagon

Design: Chrome-plated, Black Point

			mm	mm	
05002960001	PZ 1	PZ 2	6	175	7"
05140310001	PZ 2	PZ 3	6	175	7"

84 Combination blade for hexagon socket screws



Application: Hexagon socket screws

Blade: 6 mm hexagon

Design: Chrome-plated, Black Point

			mm	mm	
05002936001	2,5	2,5	6	175	7"
05002938001	3	3	6	175	7"
05002940001	4	4	6	175	7"
05002943001	5	5	6	175	7"
05002948001 ¹⁾	4	5	6	175	7"
05002946001	6	6	6	175	7"

¹⁾ without ball-end

87 Combination blade for TORX® screws



Application: TORX® socket screws

Blade: 6 mm hexagon

Design: Chrome-plated, Black Point

			mm	mm	
05002966001	TX 6	TX 8	6	175	7"
05002968001	TX 7	TX 9	6	175	7"
05002970001	TX 10	TX 15	6	175	7"
05002973001	TX 20	TX 25	6	175	7"
05002976001	TX 30	TX 40	6	175	7"

85 Combination blade for Phillips screws



Application: Phillips screws

Blade: 6 mm hexagon

Design: Chrome-plated, Black Point

			mm	mm	
05002950001	PH 1	PH 2	6	175	7"

68 Combination blade for square socket screws



Application: For square socket screws

Blade: 6 mm hexagon

Design: Mat nickel, Black Point

			mm	mm	
05002980001	#1	#2	6	175	7"



044 377-0

Unt. Bwg 20.9.72





Wera 2go

	Wera 2go 1 Tool Carrier	300
	Wera 2go 2 Tool Container	300
	Wera 2go 3 Tool Box	300
	Wera 2go 4 Tool Quiver	300
	Wera 2go 5 Tool Carrier	301
	Wera 2go 6 Shoulder Strap	301
	Hook and Loop Fastener Strips	303



Wera 2go

We wanted to provide our textile boxes and pouches with a mobile home.

After all, increasingly more users are more often out and about with their tools and they frequently complain about too much weight.

So we started searching for an idea which would keep the hands free during walking and with which one could dock and undock the required tools very easily.



Wera 2go 1 – The outside packer
Wera 2go Tool Carrier with hook and loop fastener system. For the docking of the Wera textile boxes and pouches with hook and loop fastener zones. Individually configurable for greater mobility. Hands remain free during transport. Includes an adjustable, detachable Shoulder Strap with a wide padded section.

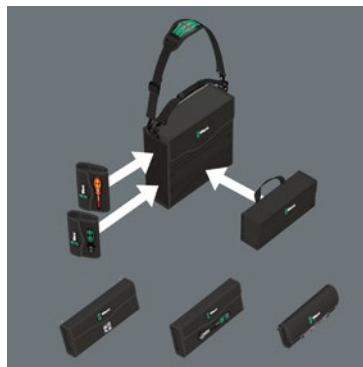

Wera 2go 2 – The outside and inside packer
Wera 2go Tool Container with inner and outer hook and loop fastener system. Individually configurable for greater mobility. Ideal also for the docking of Wera textile boxes and pouches equipped with hook and loop fastener zones. Easy insertion and removal. Hands remain free during transport.



Wera 2go 3 – The inside packer
Permanently dimensionally stable thanks to the fabric-lined plastic panels. High resistance against cuts and stabs. High protection of the tools transported against damage and moisture. Can be individually equipped.

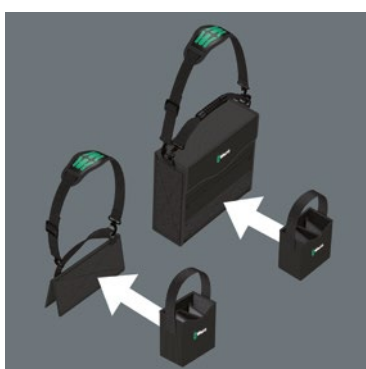

Wera 2go 4 – Tool Quiver

Dimensionally stable Wera 2go Tool Quiver. High resistance against cuts and stabs. Variable hook and loop fastener partition for a division into as many as 5 inner sections. Large set-down area; handle for carrying and hanging up.

Wera 2go

Tool transport - mobile, flexible, individual

Wera 2go 1 Tool Carrier







1 tool carrier with hook and loop fastener system for the attachment of other Wera 2go components as well as Wera textile boxes and pouches with hook and loop fastener zones; 1 shoulder strap with adjustable-width padding, adjustable in length, detachable.

	
05004350001	
	Wera 2go 5 1 x 135x300x270
	Wera 2go 6 1 x 38x1470

Wera 2go 3 Tool Box



1 dimensionally stable and robust Tool Box, empty, equipped with handle for the storage and transport of tools and small parts; high resistance against cuts and stabs; comes with hook and loop fastener zone for docking with the Wera 2go system.

			
			
	mm	mm	mm
05004352001	130	325	80

Wera 2go 2 Tool Container





1 dimensionally stable, robust Tool Container with hook and loop fastener system for the attachment of other Wera 2go components as well as Wera textile boxes and pouches with hook and loop fastener zones; high resistance against cuts and stabs; 1 handle and 1 Shoulder Strap with adjustable-width padding, adjustable in length, detachable; 1 removable Tool Quiver with handle and a variable hook and loop fastener partition for a division into as many as 5 inner sections.

05004351001	
	Wera 2go Container 1 x 330x355x115
	Wera 2go 6 1 x 38x1470
	Wera 2go 4 1 x 165x165x105

Wera 2go 4 Tool Quiver



1 dimensionally stable and robust Tool Quiver, empty, equipped with handle for the storage and transport of tools; high resistance against cuts and stabs; comes with hook and loop fastener zone for docking with the Wera 2go system and includes 1 variably adjustable hook and loop fastener partition for a division into as many as 5 sections.

			
	mm	mm	mm
05004353001	165	165	105

Wera 2go 5 Tool Carrier



1 Tool Carrier with hook and loop fastener system for the attachment of other Wera 2go components as well as Wera textile boxes and pouches with hook and loop fastener zones.

	mm	mm	mm
05004354001	135	300	270

Wera 2go 6 Shoulder Strap



1 Shoulder Strap, adjustable in length with variable-width padding for great carrying comfort and convenience.

	mm	mm
05004355001	38	1470

Tip

Robust and dimensionally stable



The robust and dimensionally stable material protects the tools carried against damage and moisture and enhances the service life of the tool container.

Variable thanks to the hook and loop fastener system



The inner and outer hook and loop fastener sections mean that other Wera 2go system components can be just as easily attached as all other Wera tools in boxes and pouches with hook and loop fastener zones. This enables an individual composition of the tools needed for a specific job.

High resistance against cuts and stabs



The robust and dimensionally stable material is very resistant against cuts and stabs. The tools carried are protected against damage and moisture. This enhances the service life of the tool box.

Perfect system supplement



Thanks to its hook and loop fastener zone, the Tool Box can be docked with the Wera 2go 1 Tool Carrier and with the Wera 2go 2 Tool Container.





” To learn more about this product, scan the QR code. “

Hook and Loop Fastener Strip 1



Self-adhesive hook and loop fastener strips. They can be attached to walls or workshop trolleys; suitable for the attachment of Wera 2go components or Wera pouches or textile boxes with nonwoven sections.

05670446001	
	Hook and Loop Fastener Strip 70 1 x 50x70

Hook and Loop Fastener Strip 2



Self-adhesive hook and loop fastener strips. They can be attached to walls or workshop trolleys; suitable for the attachment of Wera 2go components or Wera pouches or textile boxes with nonwoven sections.

05670447001	
	Hook and Loop Fastener Strip 120 1 x 50x120

Hook and Loop Fastener Strip 3



Self-adhesive hook and loop fastener strips. They can be attached to walls or workshop trolleys; suitable for the attachment of Wera 2go components or Wera pouches or textile boxes with nonwoven sections.

05670448001	
	Hook and Loop Fastener Strip 240 1 x 50x240

Tip

Would you like to attach your pouch with a nonwoven section to the wall or workshop trolley?

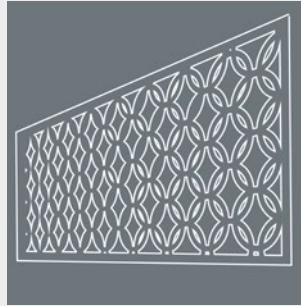

No problem! In such cases we also have self-adhesive hook and loop fastener strips available.



Which textile boxes can be docked with the Wera 2go system without the need for any additional aids?



Wera packaging bearing this symbol contains tool pouches or textile boxes with nonwoven sections that can be docked with the Wera 2go system.





Products for Power Tool Use



Bits

308



HOLDERS and Adaptors

404























Sets

430





Bits

 Bits for Phillips Screws	316	 Bits for Multi-Point Screws	396
 Bits for Pozidriv Screws	338	 Bits for Hi-TORQUE Screws	397
 Bits for PlusMinus Screws – Slotted/Phillips	350	 Bits for Microstix® Screws	398
 Bits for PlusMinus Screws – Slotted/Pozidriv	351	 Bits for Spanner Screws	400
 Bits for TORX® Screws	352	 Nutsetters	401
 Bits for TORX® BO Screws	366	 Internal Thread Insertion Tool	403
 Bits for TORX PLUS® Screws	368		
 Bits for TORX PLUS® IPR Screws	372		
 Bits for ASSY® Screws	375		
 Bits for Slotted Screws, Guide Sleeves	376		
 Bits for Hexagon Socket Screws	380		
 Bits for Hexagon Socket BO Screws	387		
 Bits for Square Socket Screws	388		
 Bits for TORQ-SET® Screws	392		
 Bits for TRI-WING®-Screws	395		



Bits

The right bit for every screw and for every power tool connection. The right quality for every user.

Thanks to the high-precision profile design and the outstanding concentricity properties, Wera bits provide for dependable working and offer great durability. Wera bits are designed for professional applications in industry as well as in the trade.

They enable higher torque transfer and typically have a long service life. Material and manufacturing expertise, established over decades, combined with sophisticated hardening technologies form the foundation upon which our premium quality is based.



Impaktor Bits

Impact bits are needed when a strong power tool is used. Impact bits were specifically developed to withstand high power tool forces.

Stainless Steel Bits

Wera stainless steel bits are manufactured out of stainless steel so unsightly rust can be avoided. The stainless steel bits from Wera are vacuum ice-hardened and have the hardness and strength needed for screw connections. There are no limitations to the industrial applications they are suitable for.

BiTorsion Bits

BiTorsion bits are absolutely premium products. They have a softer BiTorsion zone which reduces the hardness of the shaft in comparison to the drive tip. This means that the peak loads that cause bit breakage and premature wear are absorbed in this zone – something which enhances the service life of the bits.



Bits with diamond coating

The diamond coating of the DC bits lowers the danger of slipping as the minute diamond particles literally “bite” themselves into the screw head.

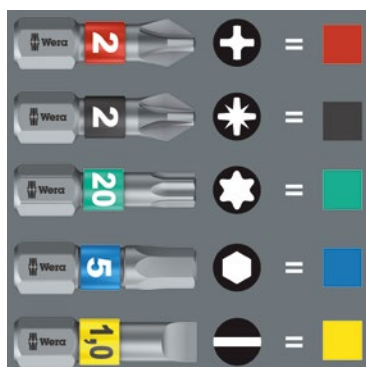

“Take it easy”

“Take it easy” tool finder with colour coding according to profiles and size stamp – for simple and rapid accessing of the required tool.



Impaktor Bits

We were not too happy that disintegrating bits flew around users faces as screwdriving with power tools took place with ever-higher power outputs.

We scrutinised the geometry and material properties of the bits for every screw profile. We analysed the destroyed bits, holders and screws in detail. The result is the Impaktor system – our entire know-how from bit manufacturing combined in our very best bit series.



For use with impact screwdrivers. Improve productivity when screwdriving with power tools.



Maximum utilisation of the material properties, a very special geometry – designed particularly to meet the extreme demands – as well a specific manufacturing process mean that Wera Impaktor tools have an above-average service life.



Particularly high strength. Reduce the danger of premature bit breakage.

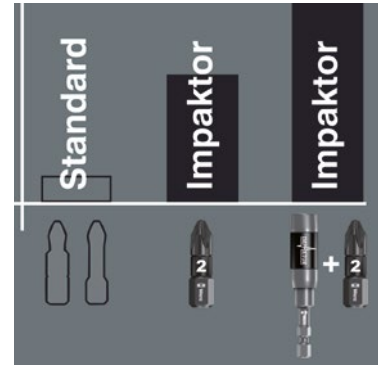

Torsion zone specially designed to absorb such forces and thereby protect the bit tip.



Another product advantage is the coating of the Impaktor bits with minute diamond particles.



These diamond particles reduce the cam-out effects – particularly high in power tool applications – which can lead to a slipping out of the screw head. The diamond particles literally bite themselves into the screw recess. This means that less contact pressure is required, something that greatly delays fatigue setting-in in power tool screwdriving jobs.



Wera's Impaktor system consisting of Impaktor bits and Impaktor holders is today's necessary addition to the BiTorsion system with the creation of the TriTorsion system.



The combination of the double torsion zones in the Impaktor holder and the torsion zone in the Impaktor bit result in the so-called TriTorsion system.



BiTorsion Bits

Peak forces that occur in power tool applications often result in premature wear of bits or damage to the screw head. This usually occurs during initial power-up and the when the screw comes to a standstill.

Screwdriving could become more productive and safer if these peak loads could be minimised. The Wera BiTorsion system prevents premature wear. The service life of the tool is extended and the productivity of power tool applications significantly increased.



The torsion spring integrated into the unique BiTorsion holder absorbs lower levels of peak loads (Phase 1). Any overloading of this spring is effectively prevented by means of a supporting mechanism.

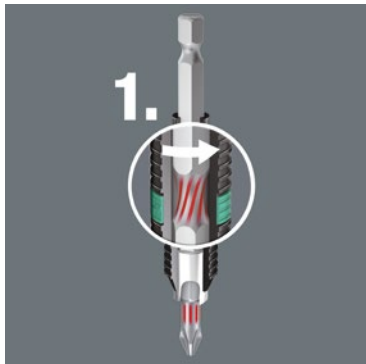

Higher peak loads are minimised through the torsion effect of the bit shaft (Phase 2). This effect is achieved with a specific heat treatment after the hardening process of the bits. This reduces the hardness of the shaft in comparison to the drive tip.

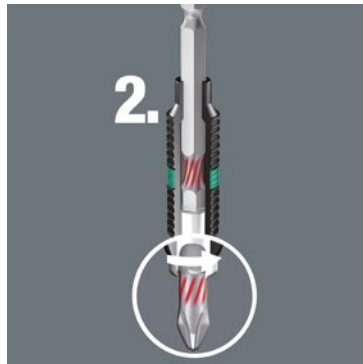

The BiTorsion holder and the BiTorsion bit can, of course, be used independently of one another.

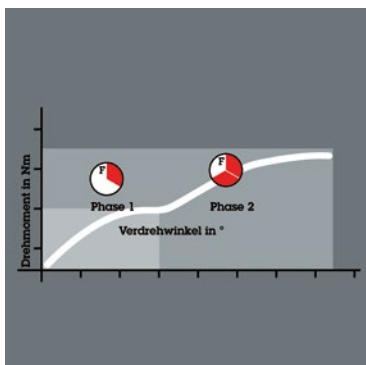

Even the service life of conventional bits is enhanced with the use of the BiTorsion holder and the BiTorsion bit also functions in a normal holder.



The effectiveness of the BiTorsion system comes from a combination of two shock-absorbing spring elements. Both bits as well as holders have a cushioning torsion zone that diverts the kinetic energy away from the drive tip during peak loads.



The optimally coordinated features of the torsion zones on the bit and holder permit a phased yield when under strain. The two-phase system prevents premature wear. Moreover, a long tool service life is also ensured by the hardness of the bits that matches the respective application.



NO STEP



Diamond-coated Bits

One of the greatest problems with power tool applications is that the conventional bit easily slips out of the head of the screw (cam-out). This often destroys both the head of the screw and the tool.

High resulting costs are incurred e.g. from damaged surfaces and screw connections that can no longer be loosened.

Screwdriving will become safer and more economic if this problem of slipping can be minimised.



To solve this fundamental problem, Wera launched a diamond-coated bit on to the market in 1992.



Today, the Wera diamond bit – manufactured with the technology specifically developed by Wera for this application – still sets the standard in terms of resilience and functionality. Wera bits with a diamond coating ensure a secure fit of the bit in the screw head.



Particularly when applications involve sensitive materials or high quality surfaces are involved, bits with a diamond coating ensure that work is done safer, faster and at lower cost.

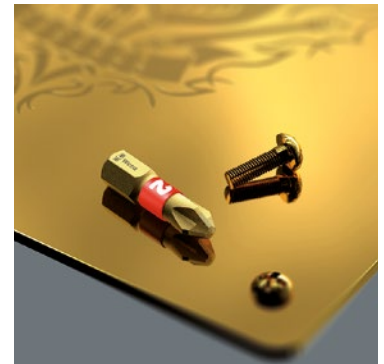

The minute diamond particles applied to the tip of the tool literally “bite” into the screw and ensure an exact, anti-slip fit in the head of the screw. This secure fit protects the screw. The cam-out forces which compel the user to apply greater pressure to the screw are considerably reduced.



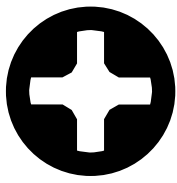

Bits for Phillips Screws



1/4" hexagon drive, suitable for D 6,3 bit holders (series 1)

851/1 IMP DC Impaktor bits



Application: Phillips screws

Drive: 1/4" hexagon, suitable for DIN ISO 1173-D 6,3 bit holders

Design: The Impaktor technology ensures an above-average service life even under extreme conditions thanks to a best-possible utilisation of the material properties and optimally designed geometry, particularly suitable for use with conventional impact drivers, the rough diamond coating reduces the danger of any slipping out of the screw head due to the enhanced frictional resistance. Take it easy toolfinder: Output colour coding (red = Phillips) and large stamp to enable the desired bit to be easily located.

	+	mm	"
05057615001	PH 1	25	1"
05057616001	PH 2	25	1"
05057617001	PH 3	25	1"

Bit-Box 15 Impaktor PH

	+		4013288
05057752001	851/1 IMP DC	15 x PH 2x25	187918



851/1 IMP DC SB Impaktor bits

	+		4013288
05073916001	1 x PH 2x25	158369	
05073917001	1 x PH 3x25	158376	



3851/1 TS bits, stainless



Application: Phillips screws

Drive: 1/4" hexagon, suitable for DIN ISO 1173-D 6,3 bit holders

Design: Stainless steel for minimising rust, special torsion-style design to reduce premature wear. Take it easy toolfinder: Output colour coding (red = Phillips) and large stamp to enable the desired bit to be easily located.

	+	mm	"
05071010001	PH 1	25	1"
05071011001	PH 2	25	1"
05071012001	PH 3	25	1"

3851/1 TS SB bits, stainless

	+		4013288
05073610001	1 x PH 1x25	112132	
05073611001	1 x PH 2x25	112149	
05073612001	1 x PH 3x25	112156	



851/1 BDC bits



Application: Phillips screws

Drive: 1/4" hexagon, suitable for DIN ISO 1173-D 6,3 bit holders

Design: BiTorsion for long service life, diamond-coated for secure screw fit. Take it easy toolfinder: Output colour coding (red = Phillips) and large stamp to enable the desired bit to be easily located.

	+	mm	"
05056400001	PH 1	25	1"
05056402001	PH 2	25	1"
05056404001	PH 3	25	1"

851/1 BDC SB bits

		4013288
05073332001	1 x PH 1x25	029324
05073333001	1 x PH 2x25	029331
05073334001	1 x PH 3x25	029348
05073335001	2 x PH 2x25	029355

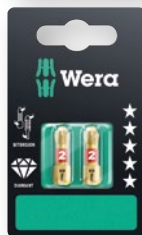
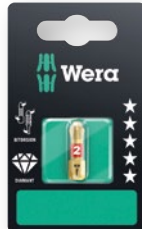

Tip



Impaktor-Bits



Impact-Bits are needed when a strong power tool (e.g. 18 volt impact screwdriver) is used. Impact bits were specifically developed to withstand high power tool forces.



Stainless Steel Bits



Wera stainless steel bits are manufactured out of stainless steel so unsightly rust can be avoided. The stainless steel bits from Wera are vacuum ice-hardened and have the hardness and strength needed for screw connections. There are no limitations to the industrial applications they are suitable for.



"Take it easy"

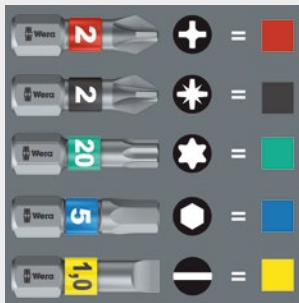

"Take it easy" tool finder with colour coding according to profiles and size stamp – for simple and rapid accessing of the required tool.





Bits for Phillips Screws



1/4" hexagon drive, suitable for D 6,3 bit holders (series 1)

851/1 BTH bits



Application: Phillips screws

Drive: 1/4" hexagon, suitable for DIN ISO 1173-D 6,3 bit holders

Design: BiTorsion for long service life, extra-hard. Take it easy toolfinder: Output colour coding (red = Phillips) and large stamp to enable the desired bit to be easily located.

	+	mm	mm
05056410001	PH 1	25	1"
05056412001	PH 2	25	1"
05056414001	PH 3	25	1"

851/1 ADC bits



Application: Phillips screws

Drive: 1/4" hexagon, suitable for DIN ISO 1173-D 6,3 bit holders

Design: Diamond-coated for secure screw fit, profiled version

	+	mm	mm	mm
05134940001	PH 1	25	1"	4,5
05134941001	PH 2	25	1"	6,0
05134942001	PH 3	25	1"	-

851/1 BTZ bits



Application: Phillips screws

Drive: 1/4" hexagon, suitable for DIN ISO 1173-D 6,3 bit holders

Design: BiTorsion for long service life, extra-tough, for universal use. Take it easy toolfinder: Output colour coding (red = Phillips) and large stamp to enable the desired bit to be easily located.

	+	mm	mm
05056420001	PH 1	25	1"
05056422001	PH 2	25	1"
05056424001	PH 3	25	1"



Application: Phillips screws

Drive: 1/4" hexagon, suitable for DIN ISO 1173-D 6,3 bit holders

Design: Extra-hard, profiled version

	+	mm	mm	mm
05134919001	PH 1	25	1"	4,5
05134920001	PH 2	25	1"	6,0
05134921001	PH 3	25	1"	-

Bit-Box 20 BTZ PH

05057751001	+	851/1 BTZ PH 20 x PH 2x25	4013288 187956
-------------	---	------------------------------	-------------------



851/1 AH bits



Application: Phillips screws

Drive: 1/4" hexagon, suitable for DIN ISO 1173-D 6,3 bit holders

Design: Industrial version for optimum torque transfer with increased depth of penetration into the screw recess, 1/4" hexagon over the entire bit length, extra-hard, profiled version

		mm	"
05380155001	PH 1	25	1"
05380156001	PH 2	25	1"
05380157001	PH 3	25	1"

851/1 RDC bits



Application: Drywall screws

Drive: 1/4" hexagon, suitable for DIN ISO 1173-D 6,3 bit holders

Design: Reduced shaft diameter, diamond-coated for secure screw fit

		mm	"	mm
05135008001	PH 2	25	1"	4,2

851/1 RH bits



Application: Phillips screws

Drive: 1/4" hexagon, suitable for DIN ISO 1173-D 6,3 bit holders

Design: Reduced shaft diameter, extra-hard, profiled version

		mm	"	mm
05380158001	PH 1	25	1"	4,2
05346281001	PH 2	25	1"	4,2

Tip

A-Bits



A stands for aviation. A bits are particularly hard bits with a sharp-edged profile which e.g. penetrates screw profiles full of paint (such as on fuselage panels) ensuring a dependable transfer of force between the bit and the screw.



Bits with diamond coating



The diamond coating of the DC bits lowers the danger of slipping as the minute diamond particles literally "bite" themselves into the screw head.

Bit-Box

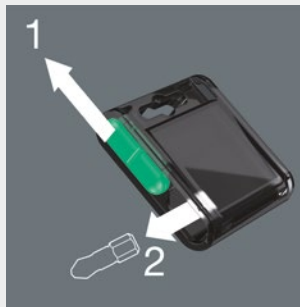

The slide switch allows a simple and gradual removal and reinsertion of the bits. The transparent reverse side means that it is easy to know how many bits are still in the box.



"Take it easy"

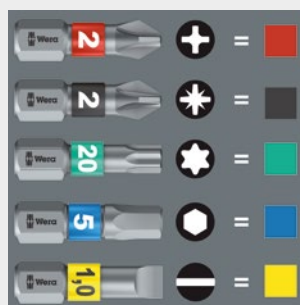

"Take it easy" tool finder with colour coding according to profiles and size stamp – for simple and rapid accessing of the required tool.





851/1 RZ bits



Application: Drywall screws

Drive: 1/4" hexagon, suitable for DIN ISO 1173-D 6,3 bit holders

Design: Reduced shaft diameter, tough, for universal use

		mm	"	mm
05135009001	PH 2	25	1"	4,2

Bit-Box 20 RZ PH

		4013288
05057753001	851/1 RZ PH 20 x PH 2x25	187987



851/1 RZ SB bits

		4013288
05135005001	2 x PH 2x25	038456



Tip



Bits with reduced shaft diameter



Bits with reduced shaft diameter ensure that screws can be sunk without damaging the surface. This is particularly necessary in drywall construction applications.

Bit-Box



The slide switch allows a simple and gradual removal and reinsertion of the bits. The transparent reverse side means that it is easy to know how many bits are still in the box.





Bits for Phillips Screws



1/4" hexagon drive, suitable for D 6,3 bit holders (series 1)

851/1 TH bits



Application: Phillips screws

Drive: 1/4" hexagon, suitable for DIN ISO 1173-D 6,3 bit holders

Design: Torsion-style design to reduce premature wear, extra-hard

	+	mm	"
05056605001	PH 1	25	1"
05056610001	PH 2	25	1"
05056625001	PH 3	25	1"

851/1 TiN bits



Application: Phillips screws

Drive: 1/4" hexagon, suitable for DIN ISO 1173-D 6,3 bit holders

Design: TiN coating for the hardness needed e.g. in series screwdriving operations

	+	mm	"
05480171001	PH 1	25	1"
05480172001	PH 2	25	1"
05480173001	PH 3	25	1"

851/1 TiN SB bits

		4013288
05073512001	2 x PH 1x25	105806
05073513001	2 x PH 2x25	106513
05073514001	2 x PH 3x25	105820
05073515001	1 x PH 1x25; 1 x PH 2x25; 1 x PH 3x25	105837



851/1 TZ bits



Application: Phillips screws

Drive: 1/4" hexagon, suitable for DIN ISO 1173-D 6,3 bit holders

Design: Torsion-style design to reduce premature wear, tough, for universal use

	+	mm	"
05056505001	PH 1	25	1"
05056510001	PH 2	25	1"
05056525001	PH 3	25	1"

851/1 TZ SB bits



4013288

05073323001	+	2 x PH 1x25	029249
05073324001	+	2 x PH 2x25	029256
05073325001	+	2 x PH 3x25	029263
05073326001	+	1 x PH 1x25; 1 x PH 2x25; 1 x PH 3x25	029270



853/1 TZ bits, ACR®



Application: Phillips screws

Drive: 1/4" hexagon, suitable for DIN ISO 1173-D 6,3 bit holders

Design: Torsion-style design to reduce premature wear, tough, for universal use, ACR® (Anti Cam-Out Ribs) prevents bits from slipping out of screw head

	+	mm	"
05056660001	PH 1	25	1"
05056662001	PH 2	25	1"
05056664001	PH 3	25	1"

Tip

ACR®-Bits



ACR® stands for "anti-cam-out ribs". ACR® bits have ribs at the drive tip that protect against slipping out of the screw head. It is recommended that ACR® bits are matched with ribbed ACR® screws for maximum effect. ACR® is a registered trademark of Phillips Screw Company.

TiN-Bits



TiN stands for titanium-nitride. An extremely hard coating to withstand permanent loads such as during continual screwdriving operations in series manufacturing.



TH-Bits



TH-Bits are hard bits with a torsion zone. Torsion bits absorb the damaging peak torque loads in the torsion zone. This prevents premature wear and enhances the service life of the bits.



TZ-Bits



TZ-Bits are tough bits with a torsion zone. Torsion bits absorb the damaging peak torque loads in the torsion zone. This prevents premature wear and enhances the service life of the bits.





Bits for Phillips Screws



1/4" hexagon drive, suitable for D 6,3 bit holders (series 1)

851/1 Z bits



Application: Phillips screws

Drive: 1/4" hexagon, suitable for DIN ISO 1173-D 6,3 bit holders

Design: Tough, for universal use

	+	mm	"
05056500001	PH 0	25	1"
05072070001	PH 1	25	1"
05056507001	PH 1	50	2"
05072072001	PH 2	25	1"
05056515001	PH 2	32	1 1/4"
05056520001	PH 2	50	2"
05072074001	PH 3	25	1"
05134905001	PH 3	50	2"
05056535001	PH 4	32	1 1/4"

Bit-Box 20 PH

	+		4013288
05057750001	851/1 PH	20 x PH 2x25	188014



851/1 Z SB bits

	+		4013288
05073304001	2 x PH 1x25	029058	
05073305001	2 x PH 2x25	029065	
05073306001	2 x PH 3x25	029072	
05073307001	1 x PH 1x25; 1 x PH 2x25; 1 x PH 3x25	029089	

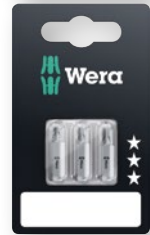

851/1 Z DIY bits

	+		4013288
05072400001	10 x PH 1x25	115737	
05072401001	10 x PH 2x25	115744	
05072402001	10 x PH 3x25	115751	



851/1 Z DIY 100 bits

	+		4013288
05072440001	100 x PH 1x25	138460	
05072441001	100 x PH 2x25	138477	







851/1 J bits



Application: Phillips screws

Drive: 1/4" hexagon, suitable for DIN ISO 1173-D 6,3 bit holders

Design: Tough, for universal use; PH 0: JCIS (Japanese Camera Industrial Standard)

		 mm	 1"	 mm
05135040001	PH 00	25	1"	2,0
05135041001	PH 0	25	1"	2,5
05135042001	PH 1	25	1"	3,0

Tip

J-Bits



J stands for Japan. J bits have been optimised to suit Asian PH screws. In particular, they are for use with very small dimensions as set out in the Japanese Camera Standard.

Bit-Box



The slide switch allows a simple and gradual removal and reinsertion of the bits. The transparent reverse side means that it is easy to know how many bits are still in the box.

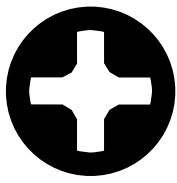

Bits for Phillips Screws



1/4" hexagon drive, suitable for F 6,3 bit holders (series 4)

851/4 IMP DC Impaktor bits



Application: Phillips screws

Drive: 1/4" hexagon, suitable for DIN ISO 1173-F 6,3 bit holders

Design: The Impaktor technology ensures an above-average service life even under extreme conditions thanks to a best-possible utilisation of the material properties and optimally designed geometry, particularly suitable for use with conventional impact drivers, the rough diamond coating reduces the danger of any slipping out of the screw head due to the enhanced frictional resistance. Take it easy toolfinder: Output colour coding (red = Phillips) and large stamp to enable the desired bit to be easily located.

	+	mm	"
05057656001	PH 2	50	2"
05057657001	PH 3	50	2"

851/4 IMP DC SB Impaktor bits

	+		4013288
05073956001	+	1 x PH 2x50	158482
05073957001	+	1 x PH 3x50	158499



3851/4 Bits, stainless



Application: Phillips screws

Drive: 1/4" hexagon, suitable for DIN ISO 1173-F 6,3 bit holders

Design: Stainless steel for minimising rust

	+	mm	"
05071081001	PH 1	89	3 1/2"
05071082001	PH 2	89	3 1/2"
05071083001	PH 3	89	3 1/2"

851/4 BDC bits



Application: Phillips screws

Drive: 1/4" hexagon, suitable for DIN ISO 1173-F 6,3 bit holders

Design: BiTorsion for long service life, diamond-coated for secure screw fit. Take it easy toolfinder: Output colour coding (red = Phillips) and large stamp to enable the desired bit to be easily located.

	+	mm	"
05059530001	PH 1	50	2"
05059532001	PH 2	50	2"
05059534001	PH 3	50	2"

851/4 BTH bits



Application: Phillips screws

Drive: 1/4" hexagon, suitable for DIN ISO 1173-F 6,3 bit holders

Design: BiTorsion for long service life, extra-hard. Take it easy toolfinder: Output colour coding (red = Phillips) and large stamp to enable the desired bit to be easily located.

	+	mm	"
05059540001	PH 1	50	2"
05059542001	PH 2	50	2"
05059544001	PH 3	50	2"

851/4 BTZ bits



Application: Phillips screws

Drive: 1/4" hexagon, suitable for DIN ISO 1173-F 6,3 bit holders

Design: BiTorsion for long service life, extra-tough, for universal use. Take it easy toolfinder: Output colour coding (red = Phillips) and large stamp to enable the desired bit to be easily located.

	+	mm	"
05059550001	PH 1	50	2"
05059552001	PH 2	50	2"
05059554001	PH 3	50	2"

Tip



Impaktor-Bits



Impact-Bits are needed when a strong power tool (e.g. 18 volt impact screwdriver) is used. Impact bits were specifically developed to withstand high power tool forces.



BDC-Bits



BDC-Bits are absolutely premium products. They have a softer BiTorsion zone which reduces the hardness of the shaft by about 20 % in comparison to the drive tip. This means that the peak loads that cause bit breakage and premature wear are absorbed in this zone – something which enhances the service life of the bits.

The diamond coating lowers the danger of slipping as the minute diamond particles literally "bite" themselves into the screw head. B stands for BiTorsion. DC stands for diamond coated.



"Take it easy"

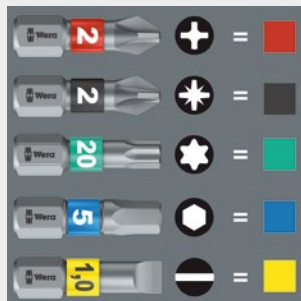

"Take it easy" tool finder with colour coding according to profiles and size stamp – for simple and rapid accessing of the required tool.



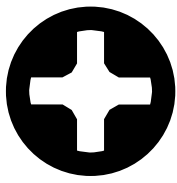

Bits for Phillips Screws



1/4" hexagon drive, suitable for F 6,3 bit holders (series 4)

851/4 ADC bits



Application: Phillips screws

Drive: 1/4" hexagon, suitable for DIN ISO 1173-F 6,3 bit holders

Design: Extra-hard, diamond-coated for secure screw fit, profiled version

	+	mm	mm	mm
05134950001	PH 1	50	2"	4,5
05134951001	PH 2	50	2"	6
05134952001	PH 3	50	2"	-

851/4 A bits



Application: Phillips screws

Drive: 1/4" hexagon, suitable for DIN ISO 1173-F 6,3 bit holders

Design: Extra-hard, profiled version

	+	mm	mm	mm
05134929001	PH 0	50	2"	3
05134906001	PH 0	70	2 3/4"	3
05134907001	PH 0	89	3 1/2"	3
05134908001	PH 0	152	6"	3
05134930001	PH 1	50	2"	4,5
05134370001	PH 1	70	2 3/4"	4,5
05134372001	PH 1	89	3 1/2"	4,5
05134909001	PH 1	152	6"	4,5
05134931001	PH 2	50	2"	6
05134371001	PH 2	70	2 3/4"	6
05134373001	PH 2	89	3 1/2"	6
05134910001 ¹⁾	PH 2	152	6"	6
05134911001 ²⁾	PH 2	152	6"	6
05134932001	PH 3	50	2"	-
05134912001	PH 3	50	2"	8
05134913001	PH 3	70	2 3/4"	8
05134914001	PH 3	89	3 1/2"	8
05134915001	PH 3	152	6"	8
05160983001	PH 4	50	2"	10

¹⁾ Length of drive 100 mm

²⁾ Length of drive 20 mm

851/4 RH Reduced tip bits

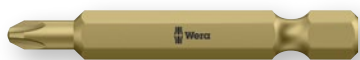

Application: Phillips screws

Drive: 1/4" hexagon, suitable for DIN ISO 1173-F 6,3 bit holders

Design: Reduced shaft diameter, extra-hard

	+	mm	mm	mm
05380160001	PH 1	50	2"	4,2
05380161001	PH 2	50	2"	4,2

851/4 R Reduced tip bits



Application: Phillips screws

Drive: 1/4" hexagon, suitable for DIN ISO 1173-F 6,3 bit holders

Design: Reduced shaft diameter

		 mm	 "	 mm
05160899001	PH 2	50	2"	3,0
05160896001	PH 2	152	6"	3,0

851/4 TH bits



Application: Phillips screws

Drive: 1/4" hexagon, suitable for DIN ISO 1173-F 6,3 bit holders

Design: Torsion-style design to reduce premature wear, extra-hard

		 mm	 "
05059855001	PH 1	50	2"
05059860001	PH 2	50	2"
05059865001	PH 3	50	2"

Tip



Bits with reduced shaft diameter



Bits with reduced shaft diameter ensure that screws can be sunk without damaging the surface. This is particularly necessary in drywall construction applications.

A-Bits



A stands for aviation. A bits are particularly hard bits with a sharp-edged profile which e.g. penetrates screw profiles full of paint (such as on fuselage panels) ensuring a dependable transfer of force between the bit and the screw.



Bits with diamond coating



The diamond coating of the DC bits lowers the danger of slipping as the minute diamond particles literally "bite" themselves into the screw head.





Bits for Phillips Screws



1/4" hexagon drive, suitable for F 6,3 bit holders (series 4)

851/4 TZ bits



Application: Phillips screws

Drive: 1/4" hexagon, suitable for DIN ISO 1173-F 6,3 bit holders

Design: Torsion-style design to reduce premature wear, tough, for universal use

	+	l ¹ mm	l ²
05059805001	PH 1	50	2"
05059810001	PH 2	50	2"
05059815001	PH 3	50	2"

851/4 TZ SB bits

	+		4013288
05134380001	+	2 x PH 1x50	037947
05134381001	+	2 x PH 2x50	037954
05134382001	+	2 x PH 3x50	037961



851/4 J bits



Application: Phillips screws

Drive: 1/4" hexagon, suitable for DIN ISO 1173-F 6,3 bit holders

Design: Tough, for universal use

	+	l ¹ mm	l ²	∅ mm
05135530001	PH 00	50	2"	2,0
05380200001	PH 00	89	3 1/2"	2,0
05135531001 ¹⁾	PH 0	50	2"	2,5
05380201001 ¹⁾	PH 0	89	3 1/2"	2,5
05135532001	PH 1	50	2"	4,5
05380202001	PH 1	89	3 1/2"	4,5

¹⁾ Size 0 modified according to JCIS 0 (Japanese Camera Industrial Standard)

851/4 Z bits



Application: Phillips screws

Drive: 1/4" hexagon, suitable for DIN ISO 1173-F 6,3 bit holders

Design: Tough, for universal use

	+	l ¹ mm	l ²	∅ mm
05059755001	PH 1	70	2 3/4"	4,5
05059760001	PH 1	89	3 1/2"	4,5
05059765001	PH 1	127	5"	4,5
05059766001	PH 1	152	6"	4,5
05059770001	PH 2	70	2 3/4"	6,0
05059775001	PH 2	89	3 1/2"	6,0
05059780001	PH 2	110	4 3/8"	6,0
05059785001	PH 2	127	5"	6,0
05059786001	PH 2	152	6"	6,0
05059790001	PH 3	70	2 3/4"	-
05059795001	PH 3	89	3 1/2"	-
05059800001	PH 3	110	4 3/8"	-
05059802001	PH 3	152	6"	-

851/4 Z SB bits

	+		4013288
05073520001	+	1 x PH 1x89	105875
05073521001	+	1 x PH 2x89	105882
05073522001	+	1 x PH 3x89	105899



853/4 ACR® bits



Application: Phillips screws

Drive: 1/4" hexagon, suitable for DIN ISO 1173-F 6,3 bit holders

Design: Tough, for universal use, ACR® (Anti Cam-Out Ribs) prevents bit from slipping out of screw head

		mm	"	mm
05346285001	PH 1	50	2"	3,5
05346286001	PH 2	50	2"	5,2
05346287001	PH 3	50	2"	5,8

853/4 Harpoon ACR® bits



Application: Phillips screws

Drive: 1/4" hexagon, suitable for DIN ISO 1173-F 6,3 bit holders

Design: Reduced shaft diameter, tough, for universal use, ACR® (Anti Cam-Out Ribs) prevents bit from slipping out of screw head

		mm	"	mm
05160901001	PH 2	50	2"	3,3
05160895001	PH 2	70	2 3/4"	3,3
05160908001	PH 2	152	6"	3,3

Tip

ACR®-Bits:



ACR® stands for "anti-cam-out ribs". ACR® bits have ribs at the drive tip that protect against slipping out of the screw head. It is recommended that ACR® bits are matched with ribbed ACR® screws for maximum effect. ACR® reg. trademark of Phillips Screw Company.

J-Bits



J stands for Japan. J bits have been optimised to suit Asian PH screws. In particular, they are for use with very small dimensions as set out in the Japanese Camera Standard.





Bits for Phillips Screws



Double-ended bits, 1/4" hexagon drive (series 23)

851/23 double-ended bits for Phillips screws



Application: Phillips screws
Drive: 1/4" hexagon
Design: Ball-guide groove 17 mm

		mm	
05135705001	PH 2	45	1 25/32"
05135706001	PH 2	65	2 9/16"



5/16" hexagon drive, suitable for D 8 bit holders or direct drive (series 2)

851/2 Z bits



Application: Phillips screws
Drive: 5/16" hexagon, suitable for DIN ISO 1173-D 8 bit holders
Design: Tough, for universal use

		mm		mm
05057705001	PH 1	32	1 1/4"	4,5
05057710001	PH 2	32	1 1/4"	6,0
05057715001	PH 3	32	1 1/4"	7,6
05057720001	PH 4	32	1 1/4"	-
05057725001	PH 4	38	1 1/2"	10,0



M 4 Thread drive M 4 direct drive (series 11)





851/11 Bits



Application: Phillips screws

Drive: Thread drive M 4

Design: Tough, for universal use

		 mm	 mm	 mm
05065075001	PH 1	33	1 1/4"	5,5
05065081001	PH 2	33	1 1/4"	6,0



M 5 Thread drive M 5 direct drive (series 12)



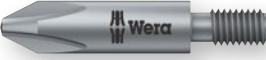

851/12 Bits



Application: Phillips screws

Drive: Thread drive M 5

Design: Tough, for universal use

		 mm	 mm	 mm
05065110001	PH 2	33	1 1/4"	7,0
05065112001	PH 2	35	1 3/8"	7,0
05065114001	PH 2	44,5	1 3/4"	6,0
05065116001	PH 2	50	2"	6,0



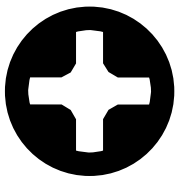

Bits for Phillips Screws



M 6 Thread drive M 6 direct drive (series 15)

851/15 Bits



Application: Phillips screws

Drive: Thread drive M 6

Design: Tough, for universal use

		mm		mm
05065150001	PH 2	33	1 1/4"	8,0
05065152001	PH 2	35	1 3/8"	8,0
05065154001	PH 2	44,5	1 3/4"	8,0



#10/32" Thread drive #10-32 UNF direct drive (series 16)

851/16 Bits

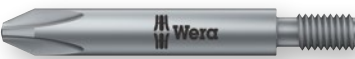

Application: Phillips screws

Drive: Thread drive #10-32 UNF

Design: Tough, for universal use

		mm		mm
05065197001	PH 2	44,5	1 3/4"	6,0



4 mm 4 mm Halfmoon direct drive (series 9)

851/9 C J PH bits, halfmoon



Application: Phillips screws

Drive: Halfmoon, 4 mm

Design: Hard

		 mm	 mm	 mm	 mm	 mm
05134605001 ¹⁾	PH 000	44	1 47/64"	1,5	20	25/32"
05134606001 ¹⁾	PH 000	64	2 33/64"	1,5	20	25/32"
05135270001 ¹⁾	PH 00	44	1 47/64"	1,8	20	25/32"
05135271001 ¹⁾	PH 00	64	2 33/64"	1,8	20	25/32"
05135272001 ²⁾	PH 0	44	1 47/64"	1,8	20	25/32"
05135273001 ²⁾	PH 0	64	2 33/64"	1,8	20	25/32"
05135274001 ²⁾	PH 0	44	1 47/64"	2,0	20	25/32"
05135275001 ²⁾	PH 0	64	2 33/64"	2,2	20	25/32"
05135278001 ²⁾	PH 0	44	1 47/64"	2,2	20	25/32"
05135276001 ¹⁾	PH 1	44	1 47/64"	3,0	20	25/32"
05135277001 ¹⁾	PH 1	64	2 33/64"	3,0	20	25/32"
05134607001	PH 2	44	1 47/64"	4,0	-	-
05134608001	PH 2	64	2 33/64"	4,0	-	-

¹⁾ Optimised for Asian PH screws

²⁾ Size 0 modified according to JCIS 0 (Japanese Camera Industrial Standard)



4 mm 4 mm HIOS direct drive (series 21)

851/21 J bits



Application: Phillips screws

Drive: HIOS 4 mm

Design: Hard

		 mm	 mm	 mm
05135280001 ¹⁾	PH 00	40	1 9/16"	1,8
05135281001 ¹⁾	PH 00	60	2 3/8"	1,8
05135284001 ²⁾	PH 0	40	1 9/16"	1,8
05135285001 ²⁾	PH 0	60	2 3/8"	1,8
05135286001 ²⁾	PH 0	40	1 9/16"	2,0
05135287001 ²⁾	PH 0	60	2 3/8"	2,0
05135288001 ²⁾	PH 0	40	1 9/16"	2,5
05135289001 ²⁾	PH 0	60	2 3/8"	2,5
05135290001	PH 1	40	1 9/16"	3,0
05135291001	PH 1	60	2 3/8"	3,0

¹⁾ Size 00 modified according to JCIS 00 (Japanese Camera Industrial Standard) modifiziert

²⁾ Size 0 modified according to JCIS 0 (Japanese Camera Industrial Standard)





Bits for Phillips Screws

 5 mm 5 mm HIOS direct drive (series 22)







851/22 J bits



Application: Phillips screws

Drive: HIOS 5 mm

Design: Hard; PH 0: JCIS (Japanese Camera Industrial Standard)

		 mm	 mm	 mm	 mm	 mm
05135380001 ¹⁾	PH 00	60	2 ³ / ₈ "	2,0	20	²⁵ / ₃₂ "
05135381001 ²⁾	PH 0	60	2 ³ / ₈ "	2,0	20	²⁵ / ₃₂ "
05135382001 ²⁾	PH 0	80	3 ¹ / ₈ "	2,0	20	²⁵ / ₃₂ "
05135383001 ²⁾	PH 0	60	2 ³ / ₈ "	2,5	20	²⁵ / ₃₂ "
05135384001 ²⁾	PH 0	80	3 ¹ / ₈ "	2,5	20	²⁵ / ₃₂ "
05135385001	PH 1	60	2 ³ / ₈ "	3,0	20	²⁵ / ₃₂ "
05135386001	PH 1	80	3 ¹ / ₈ "	3,0	20	²⁵ / ₃₂ "
05135387001	PH 1	100	4"	3,0	20	²⁵ / ₃₂ "

¹⁾ Size 00 modified according to JCIS 00 (Japanese Camera Industrial Standard) modifiziert

²⁾ Size 0 modified according to JCIS 0 (Japanese Camera Industrial Standard)



⁵/₁₆ "

5/16" external square drive (series 25)

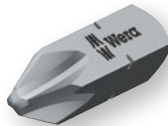

851/25 H bits



Application: Phillips screws

Drive: ⁵/₁₆ " external square

Design: Extra-hard

		 mm	 mm
05380380001	PH 1	29	1 ³ / ₁₆ "
05380381001	PH 2	29	1 ³ / ₁₆ "
05380382001	PH 3	29	1 ³ / ₁₆ "
05380383001	PH 4	29	1 ³ / ₁₆ "



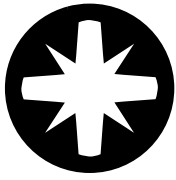

Bits for Pozidriv Screws



1/4" hexagon drive, suitable for D 6,3 bit holders (series 1)

855/1 IMP DC Impaktor bits



Application: Suitable for Pozidriv screws

Drive: 1/4" hexagon, suitable for DIN ISO 1173-D 6,3 bit holders

Design: The Impaktor technology ensures an above-average service life even under extreme conditions thanks to a best-possible utilisation of the material properties and optimally designed geometry, particularly suitable for use with conventional impact drivers, the rough diamond coating reduces the danger of any slipping out of the screw head due to the enhanced frictional resistance. Take it easy toolfinder: Output colour coding (black = Pozidriv) and large stamp to enable the desired bit to be easily located.

		mm	"
05057620001	PZ 1	25	1"
05057621001	PZ 2	25	1"
05057622001	PZ 3	25	1"

Bit-Box 15 Impaktor PZ

		4013288
05057763001	855/1 IMP DC 15 x PZ 2x25	187901



3855/1 TS bits, stainless



Application: Suitable for Pozidriv screws

Drive: 1/4" hexagon, suitable for DIN ISO 1173-D 6,3 bit holders

Design: Stainless steel for minimising rust, special torsion-style design to reduce premature wear. Take it easy toolfinder: Output colour coding (black = Pozidriv) and large stamp to enable the desired bit to be easily located.

		mm	"
05071020001	PZ 1	25	1"
05071021001	PZ 2	25	1"
05071022001	PZ 3	25	1"

3855/1 TS SB bits, stainless

		4013288
05073613001	1 x PZ 1x25	112101
05073614001	1 x PZ 2x25	112118
05073615001	1 x PZ 3x25	112125



855/1 IMP DC SB Impaktor bits

		4013288
05073921001	1 x PZ 2x25	158383
05073922001	1 x PZ 3x25	158390



855/1 BDC bits



Application: Suitable for Pozidriv screws

Drive: 1/4" hexagon, suitable for DIN ISO 1173-D 6,3 bit holders

Design: BiTorsion for long service life, diamond-coated for secure screw fit. Take it easy toolfinder: Output colour coding (black = Pozidriv) and large stamp to enable the desired bit to be easily located.

		mm	
05056700001	PZ 1	25	1"
05056702001	PZ 2	25	1"
05056704001	PZ 3	25	1"

855/1 BDC SB bits

		4013288
05073336001	1 x PZ 1x25	029362
05073337001	1 x PZ 2x25	029379
05073338001	1 x PZ 3x25	029386
05073339001	2 x PZ 2x25	029393

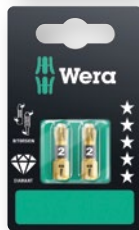
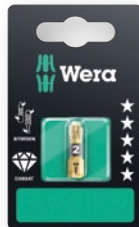

Tip



Impaktor-Bits



Impact-Bits are needed when a strong power tool (e.g. 18 volt impact screwdriver) is used. Impact bits were specifically developed to withstand high power tool forces.



BDC-Bits



BDC-Bits are absolutely premium products. They have a softer BiTorsion zone which reduces the hardness of the shaft by about 20 % in comparison to the drive tip. This means that the peak loads that cause bit breakage and premature wear are absorbed in this zone – something which enhances the service life of the bits. The diamond coating lowers the danger of slipping as the minute diamond particles literally “bite” themselves into the screw head. B stands for BiTorsion. DC stands for diamond coated.



“Take it easy”

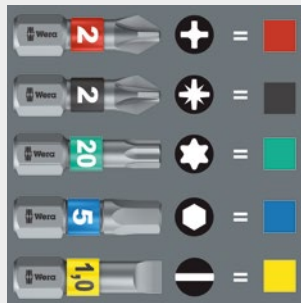

“Take it easy” tool finder with colour coding according to profiles and size stamp – for simple and rapid accessing of the required tool.



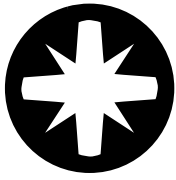

Bits for Pozidriv Screws



1/4" hexagon drive, suitable for D 6,3 bit holders (series 1)

855/1 BTH bits



Application: Suitable for Pozidriv screws

Drive: 1/4" hexagon, suitable for DIN ISO 1173-D 6,3 bit holders

Design: BiTorsion for long service life, extra-hard. Take it easy toolfinder: Output colour coding (black = Pozidriv) and large stamp to enable the desired bit to be easily located.

		mm	"
05056710001	PZ 1	25	1"
05056712001	PZ 2	25	1"
05056714001	PZ 3	25	1"

Bit-Box 20 BTH PZ

05057762001	855/1 BTH PZ 20 x PZ 2x25	4013288 187963



855/1 BTZ bits



Application: Suitable for Pozidriv screws

Drive: 1/4" hexagon, suitable for DIN ISO 1173-D 6,3 bit holders

Design: BiTorsion for long service life, extra-tough, for universal use. Take it easy toolfinder: Output colour coding (black = Pozidriv) and large stamp to enable the desired bit to be easily located.

		mm	"
05056720001	PZ 1	25	1"
05056722001	PZ 2	25	1"
05056724001	PZ 3	25	1"

Bit-Box 20 BTZ PZ

05057761001	855/1 BTZ PZ 20 x PZ 2x25	4013288 187970



855/1 RZ bits



Application: Quick-build Pozidriv screws

Drive: 1/4" hexagon, suitable for DIN ISO 1173-D 6,3 bit holders

Design: Reduced shaft diameter, tough, for universal use

		mm	"	mm
05135017001	PZ 1	25	1"	4,2
05135003001	PZ 2	25	1"	4,2

855/1 TH bits



Application: Suitable for Pozidriv screws

Drive: 1/4" hexagon, suitable for DIN ISO 1173-D 6,3 bit holders

Design: Torsion-style design to reduce premature wear, extra-hard

		 mm	 1"
05056910001	PZ 1	25	1"
05056915001	PZ 2	25	1"
05056925001	PZ 3	25	1"

855/1 TH SB bits

05073370001	2 x PZ 1x25	4013288 029638
05073371001	2 x PZ 2x25	029645
05073372001	2 x PZ 3x25	029652
05073373001	1 x PZ 1x25; 1 x PZ 2x25; 1 x PZ 3x25	029669



855/1 TiN bits



Application: Suitable for Pozidriv screws

Drive: 1/4" hexagon, suitable for DIN ISO 1173-D 6,3 bit holders

Design: TiN coating for the hardness needed e.g. in series screwdriving operations

		 mm	 1"
05480221001	PZ 1	25	1"
05480222001	PZ 2	25	1"
05480223001	PZ 3	25	1"

855/1 TiN SB bits

05073516001	2 x PZ 1x25	4013288 106445
05073517001	2 x PZ 2x25	105844
05073518001	2 x PZ 3x25	105851
05073519001	1 x PZ 1x25; 1 x PZ 2x25; 1 x PZ 3x25	105868

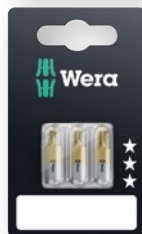
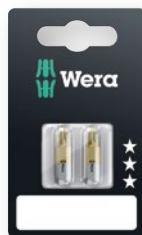

Tip



Bits with reduced shaft diameter



Bits with reduced shaft diameter ensure that screws can be sunk without damaging the surface. This is particularly necessary in drywall construction applications.

TiN-Bits



TiN stands for titanium-nitrite. An extremely hard coating to withstand permanent loads such as during continual screwdriving operations in series manufacturing.

Bit-Box

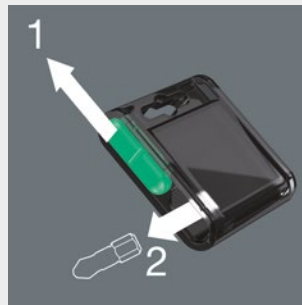

The slide switch allows a simple and gradual removal and reinsertion of the bits. The transparent reverse side means that it is easy to know how many bits are still in the box.



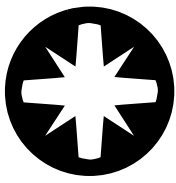

Bits for Pozidriv Screws



1/4" hexagon drive, suitable for D 6,3 bit holders (series 1)

855/1 TZ bits



Application: Suitable for Pozidriv screws

Drive: 1/4" hexagon, suitable for DIN ISO 1173-D 6,3 bit holders

Design: Torsion-style design to reduce premature wear, tough, for universal use

		mm	"
05056810001	PZ 1	25	1"
05056815001	PZ 2	25	1"
05056825001	PZ 3	25	1"

855/1 Z bits



Application: Suitable for Pozidriv screws

Drive: 1/4" hexagon, suitable for DIN ISO 1173-D 6,3 bit holders

Design: Tough, for universal use

		mm	"
05056805001	PZ 0	25	1"
05072080001	PZ 1	25	1"
05056812001	PZ 1	50	2"
05072082001	PZ 2	25	1"
05056820001	PZ 2	50	2"
05072084001	PZ 3	25	1"
05056835001	PZ 4	32	1 1/4"

856/1 TZ, ACR® bits



Application: Suitable for Pozidriv screws

Drive: 1/4" hexagon, suitable for DIN ISO 1173-D 6,3 bit holders

Design: Torsion-style design to reduce premature wear, tough, for universal use, ACR® (Anti Cam-Out Ribs) prevents bits from slipping out of screw head

		mm	"
05056937001	PZ 1	25	1"
05056938001	PZ 2	25	1"
05056939001	PZ 3	25	1"

Bit-Box 20 PZ

05057760001	855/1 Z PZ 20 x PZ 2x25	4013288 188052





855/1 Z SB bits

05073308001	2 x PZ 1x25	029096
05073309001	2 x PZ 2x25	029102
05073310001	2 x PZ 3x25	029119
05073380001	1 x PZ 4x32	029621
05073311001	1 x PZ 1x25; 1 x PZ 2x25; 1 x PZ 3x25	029126





855/1 Z DIY bits

		
05072403001	10 x PZ 1x25	4013288 115768
05072404001	10 x PZ 2x25	115775
05072405001	10 x PZ 3x25	115782



855/1 Z DIY 100 bits

		
05072443001	100 x PZ 1x25	4013288 138484
05072444001	100 x PZ 2x25	138491



Tip

ACR®-Bits:



ACR® stands for “anti-cam-out ribs”. ACR® bits have ribs at the drive tip that protect against slipping out of the screw head. It is recommended that ACR® bits are matched with ribbed ACR® screws for maximum effect. ACR® reg. trademark of Phillips Screw Company.



TZ-Bits



TZ-Bits are tough bits with a torsion zone. Torsion bits absorb the damaging peak torque loads in the torsion zone. This prevents premature wear and enhances the service life of the bits.

Bit-Box

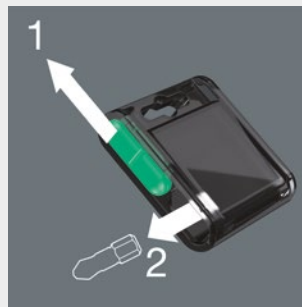

The slide switch allows a simple and gradual removal and reinsertion of the bits. The transparent reverse side means that it is easy to know how many bits are still in the box.



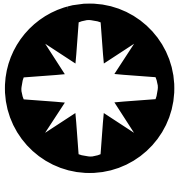

Bits for Pozidriv Screws



1/4" hexagon drive, suitable for F 6,3 bit holders (series 4)

855/4 IMP DC Impaktor bits



Application: Suitable for Pozidriv screws

Drive: 1/4" hexagon, suitable for DIN ISO 1173-F 6,3 bit holders

Design: The Impaktor technology ensures an above-average service life even under extreme conditions thanks to a best-possible utilisation of the material properties and optimally designed geometry, particularly suitable for use with conventional impact drivers, the rough diamond coating reduces the danger of any slipping out of the screw head due to the enhanced frictional resistance. Take it easy toolfinder: Output colour coding (black = Pozidriv) and large stamp to enable the desired bit to be easily located.

		 mm	
05057661001	PZ 2	50	2"
05057662001	PZ 3	50	2"

3855/4 Bits, stainless



Application: Suitable for Pozidriv screws

Drive: 1/4" hexagon, suitable for DIN ISO 1173-F 6,3 bit holders

Design: Stainless steel for minimising rust

		 mm	
05071084001	PZ 1	89	3 1/2"
05071085001	PZ 2	89	3 1/2"
05071041001	PZ 2	50	2"
05071086001	PZ 3	89	3 1/2"

855/4 IMP DC Impaktor bits SB

05073961001	1 x PZ 2x50	158505	4013288
05073962001	1 x PZ 3x50	158512	





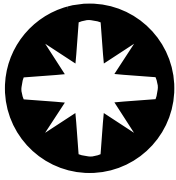

Bits for Pozidriv Screws



1/4" hexagon drive, suitable for F 6,3 bit holders (series 4)

855/4 BDC bits



Application: Suitable for Pozidriv screws

Drive: 1/4" hexagon, suitable for DIN ISO 1173-F 6,3 bit holders

Design: BiTorsion for long service life, diamond-coated for secure screw fit. Take it easy toolfinder: Output colour coding (black = Pozidriv) and large stamp to enable the desired bit to be easily located.

		 mm	
05059900001	PZ 1	50	2"
05059902001	PZ 2	50	2"
05059904001	PZ 3	50	2"

855/4 BTH bits



Application: Suitable for Pozidriv screws

Drive: 1/4" hexagon, suitable for DIN ISO 1173-F 6,3 bit holders

Design: BiTorsion for long service life, extra-hard. Take it easy toolfinder: Output colour coding (black = Pozidriv) and large stamp to enable the desired bit to be easily located.

		 mm	
05059910001	PZ 1	50	2"
05059912001	PZ 2	50	2"
05059914001	PZ 3	50	2"

855/4 BTZ bits



Application: Suitable for Pozidriv screws

Drive: 1/4" hexagon, suitable for DIN ISO 1173-F 6,3 bit holders

Design: BiTorsion for long service life, extra-tough, for universal use. Take it easy toolfinder: Output colour coding (black = Pozidriv) and large stamp to enable the desired bit to be easily located.

		 mm	
05059920001	PZ 1	50	2"
05059922001	PZ 2	50	2"
05059924001	PZ 3	50	2"

855/4 TH bits

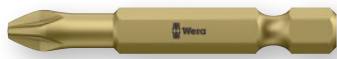

Application: Suitable for Pozidriv screws

Drive: 1/4" hexagon, suitable for DIN ISO 1173-F 6,3 bit holders

Design: Torsion-style design to reduce premature wear, extra-hard

		 mm	
05060055001	PZ 1	50	2"
05060060001	PZ 2	50	2"
05060065001	PZ 3	50	2"

855/4 TZ bits



Application: Suitable for Pozidriv screws

Drive: 1/4" hexagon, suitable for DIN ISO 1173-F 6,3 bit holders

Design: Torsion-style design to reduce premature wear, tough, for universal use

		 mm	
05060005001	PZ 1	50	2"
05060010001	PZ 2	50	2"
05060015001	PZ 3	50	2"

855/4 TZ SB bits

		 mm		
05134384001	2 x PZ 1x50			4013288 037985
05134385001	2 x PZ 2x50			037992
05134386001	2 x PZ 3x50			038005



855/4 Z bits



Application: Suitable for Pozidriv screws

Drive: 1/4" hexagon, suitable for DIN ISO 1173-F 6,3 bit holders

Design: Tough, for universal use

		 mm		 mm
05060027001	PZ 1	70	2 3/4"	4,5
05060029001	PZ 1	89	3 1/2"	4,5
05060031001	PZ 1	127	5"	4,5
05060030001	PZ 1	152	6"	4,5
05060033001	PZ 2	70	2 3/4"	6,0
05060035001	PZ 2	89	3 1/2"	6,0
05060037001	PZ 2	110	4 3/8"	6,0
05060036001	PZ 2	127	5"	6,0
05060038001	PZ 2	152	6"	6,0
05060041001	PZ 3	70	2 3/4"	-
05060043001	PZ 3	89	3 1/2"	-
05060045001	PZ 3	110	4 3/8"	-
05060047001	PZ 3	152	6"	-

855/4 Z SB bits

		 mm		
05073523001	1 x PZ 1x89			4013288 105905
05073524001	1 x PZ 2x89			106452
05073525001	1 x PZ 3x89			105912



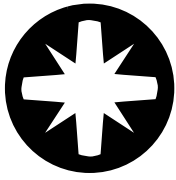

Bits for Pozidriv Screws



5/16" hexagon drive, suitable for D 8 bit holders or direct drive (series 2)

855/2 Z bits



Application: Suitable for Pozidriv screws

Drive: 5/16" hexagon, suitable for DIN ISO 1173-D 8 bit holders

Design: Tough, for universal use

		mm		mm
05058005001	PZ 1	32	1 1/4"	4,5
05058010001	PZ 2	32	1 1/4"	6,0
05058015001	PZ 3	32	1 1/4"	7,6
05058020001	PZ 4	32	1 1/4"	-
05058025001	PZ 4	38	1 1/2"	10,0



M 4 Thread drive M 4 direct drive (series 11)

855/11 Bits

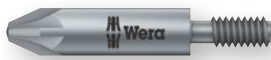

Application: Suitable for Pozidriv screws

Drive: Thread drive M 4

Design: Tough, for universal use

		mm		mm
05065090001	PZ 1	33	1 1/4"	5,5
05065096001	PZ 2	33	1 1/4"	6,0

 M 5 Thread drive M 5 direct drive (series 12)





855/12 Bits



Application: Suitable for Pozidriv screws

Drive: Thread drive M 5

Design: Tough, for universal use

		 mm	 "	 mm
05065125001	PZ 2	33	1 1/4"	7,0
05065127001	PZ 2	35	1 3/8"	7,0
05065129001	PZ 2	44,5	1 3/4"	6,0

 M 6 Thread drive M 6 direct drive (series 15)





855/15 Bits



Application: Suitable for Pozidriv screws

Drive: Thread drive M 6

Design: Tough, for universal use

		 mm	 "	 mm
05065167001	PZ 2	35	1 3/8"	8,0
05065169001	PZ 2	44,5	1 3/4"	8,0



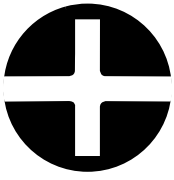

Bits for PlusMinus Screws – Phillips/Slotted



1/4" hexagon drive, suitable for F 6,3 bit holders (series 4)





851/4 PH/S PlusMinus bits



Application: PlusMinus screws (Phillips/slotted)

Drive: 1/4" hexagon suitable for DIN ISO 1173-F 6,3 bit holders

Design: PlusMinus (Phillips/slotted), tough, ideal for electrical component adjustment jobs e.g. in sheet steel or metal

		 mm	 mm	 mm
05059720001	# 1	70	2 3/4"	4,5
05059721001	# 2	70	2 3/4"	6

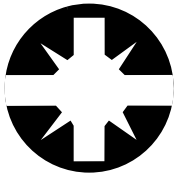

Bits for PlusMinus Screws – Pozidriv/Slotted



1/4" hexagon drive, suitable for F 6,3 bit holders (series 1)





855/4 PZ/S PlusMinus bits



Application: PlusMinus (Pozidriv/slotted) screws

Drive: 1/4" hexagon suitable for DIN ISO 1173-F 6,3 bit holders

Design: PlusMinus (slotted/Pozidriv), tough, ideal for electrical component adjustment jobs e.g. in sheet steel or metal

		 mm	 mm	 mm
05059896001	# 1	70	2 3/4"	4,5
05059897001	# 2	70	2 3/4"	6



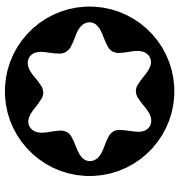

Bits for TORX® Screws



1/4" hexagon drive, suitable for D 6,3 bit holders (series 1)

867/1 IMP DC Impaktor TORX® bits



Application: TORX® socket screws

Drive: 1/4" hexagon, suitable for DIN ISO 1173-D 6,3 bit holders

Design: The Impaktor technology ensures an above-average service life even under extreme conditions thanks to a best-possible utilisation of the material properties and optimally designed geometry, particularly suitable for use with conventional impact drivers, the rough diamond coating reduces the danger of any slipping out of the screw head due to the enhanced frictional resistance. Take it easy toolfinder: Output colour coding (green = TORX®) and large stamp to enable the desired bit to be easily located.

		□, mm	□, "
05057628001	TX 10	25	1"
05057623001	TX 15	25	1"
05057624001	TX 20	25	1"
05057625001	TX 25	25	1"
05057626001	TX 30	25	1"
05057627001	TX 40	25	1"

3867/1 TS TORX® bits, stainless



Application: TORX® socket screws

Drive: 1/4" hexagon, suitable for DIN ISO 1173-D 6,3 bit holders

Design: Stainless steel for minimising rust, special torsion-style design to reduce premature wear. Take it easy toolfinder: Output colour coding (green = TORX®) and large stamp to enable the desired bit to be easily located.

		□, mm	□, "
05071030001	TX 8	25	1"
05071031001	TX 9	25	1"
05071032001	TX 10	25	1"
05071033001	TX 15	25	1"
05071034001	TX 20	25	1"
05071035001	TX 25	25	1"
05071036001	TX 27	25	1"
05071037001	TX 30	25	1"
05071038001	TX 40	25	1"

Bit-Box 15 Impaktor TX

			4013288
05057772001	867/1 IMP DC	15 x TX 20x25	187871
05057775001	867/1 IMP DC	15 x TX 25x25	187888
05057776001	867/1 IMP DC	15 x TX 30x25	187895



3867/1 TS SB TORX® bits, stainless

			4013288
05073620001	1 x TX 10x25	117670	
05073621001	1 x TX 15x25	117687	
05073622001	1 x TX 20x25	117694	
05073623001	1 x TX 25x25	117700	
05073624001	1 x TX 27x25	117717	
05073625001	1 x TX 30x25	117724	
05073626001	1 x TX 40x25	117731	



867/1 IMP DC SB Impaktor bits

			4013288
05073924001	1 x TX 20x25	163240	
05073925001	1 x TX 25x25	158406	
05073926001	1 x TX 30x25	158413	
05073927001	1 x TX 40x25	158420	



867/1 BDC TORX® bits



Application: TORX® socket screws

Drive: 1/4" hexagon, suitable for DIN ISO 1173-D 6,3 bit holders

Design: BiTorsion for long service life, diamond-coated for secure screw fit. Take it easy toolfinder: Output colour coding (green = TORX®) and large stamp to enable the desired bit to be easily located.

		mm	"
05066100001	TX 10	25	1"
05066102001	TX 15	25	1"
05066104001	TX 20	25	1"
05066106001	TX 25	25	1"
05342920001	TX 27	25	1"
05066108001	TX 30	25	1"
05066110001	TX 40	25	1"

867/1 BDC SB TORX® bits

		4013288
05134374001	1 x TX 10x25	099778
05134375001	1 x TX 15x25	099785
05134376001	1 x TX 20x25	099792
05134377001	1 x TX 25x25	099808
05134378001	1 x TX 30x25	099822
05134379001	1 x TX 40x25	099815

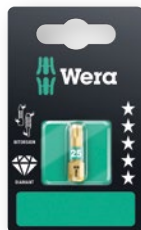

Tip



Impaktor-Bits



Impact-Bits are needed when a strong power tool (e.g. 18 volt impact screwdriver) is used. Impact bits were specifically developed to withstand high power tool forces.



BDC-Bits



BDC-Bits are absolutely premium products. They have a softer BiTorsion zone which reduces the hardness of the shaft by about 20 % in comparison to the drive tip. This means that the peak loads that cause bit breakage and premature wear are absorbed in this zone – something which enhances the service life of the bits. The diamond coating lowers the danger of slipping as the minute diamond particles literally “bite” themselves into the screw head. B stands for BiTorsion. DC stands for diamond coated.



“Take it easy”

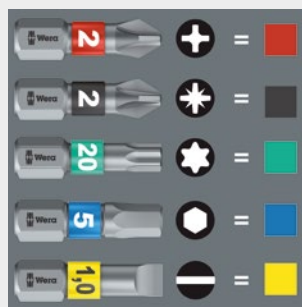

“Take it easy” tool finder with colour coding according to profiles and size stamp – for simple and rapid accessing of the required tool.



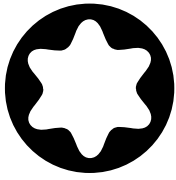

Bits for TORX® Screws



1/4" hexagon drive, suitable for D 6,3 bit holders (series 1)

867/1 BTZ TORX® bits



Application: TORX® socket screws

Drive: 1/4" hexagon, suitable for DIN ISO 1173-D 6,3 bit holders

Design: BiTorsion for long service life, extra-tough, for universal use. Take it easy toolfinder: Output colour coding (green = TORX®) and large stamp to enable the desired bit to be easily located.

		□ mm	□ "
05066120001	TX 10	25	1"
05066122001	TX 15	25	1"
05066124001	TX 20	25	1"
05066126001	TX 25	25	1"
05066128001	TX 30	25	1"
05066130001	TX 40	25	1"

867/1 Z TORX® HF bits with holding function



Application: TORX® socket screws

Drive: 1/4" hexagon, suitable for DIN ISO 1173-D 6,3 bit holders

Design: Holding function for TORX® screws made according to Acument Intellectual Properties specifications, tough, for universal use

		□ mm	□ "	∅ mm
05066070001	TX 8	25	1"	2,2
05066071001	TX 9	25	1"	2,4
05066072001	TX 10	25	1"	2,5
05066073001	TX 15	25	1"	3,0
05066074001	TX 20	25	1"	3,7
05066075001	TX 25	25	1"	4,1
05066076001	TX 27	25	1"	4,8
05066077001	TX 30	25	1"	5,4
05066078001	TX 40	25	1"	6,5

Bit-Box 20 BTZ TX

			4013288
05057771001	867/1 TORX® BTZ 20 x TX 20x25		187932
05057774001	867/1 TORX® BTZ 20 x TX 25x25		187949



867/1 TZ TORX® bits



Application: TORX® socket screws

Drive: 1/4" hexagon, suitable for DIN ISO 1173-D 6,3 bit holders

Design: Torsion-style design to reduce premature wear, tough, for universal use

		mm	"	mm
05066300001	TX 5	25	1"	4,2
05066301001	TX 6	25	1"	4,2
05066302001	TX 7	25	1"	4,2
05066303001	TX 8	25	1"	4,2
05066304001	TX 9	25	1"	4,2
05066305001	TX 10	25	1"	4,2
05066308001	TX 15	25	1"	4,2
05066310001	TX 20	25	1"	4,8
05066312001	TX 25	25	1"	5,5
05066313001	TX 27	25	1"	5,5
05066315001	TX 30	25	1"	6,0
05066320001	TX 40	25	1"	-

Tip

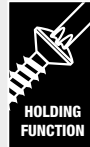

The HF profile



In tight assembly or disassembly situations, for example in engine compartments, it is not possible to securely hold the screw with the hand on the screwdriver, and the screw subsequently often gets lost. Lengthy searches or the loss of the screw (with the associated danger that could bring about) are the consequence. The HF

tools developed by Wera are ideal because they feature an optimised geometry of the original TORX® profile. The wedging forces resulting from the surface pressure between the drive tip and the screw profile mean that the screw is securely held on the tool!



BTZ-Bits



BTZ-Bits have an additional tempered BiTorsion zone, which reduces the hardness of the shaft by about 20 % in comparison to the drive tip. This means that the peak loads that cause bit breakage and premature wear are absorbed in this zone – something which enhances the service life of the bits.

Bit-Box

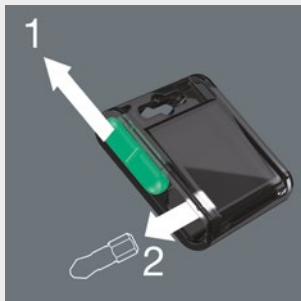

The slide switch allows a simple and gradual removal and reinsertion of the bits. The transparent reverse side means that it is easy to know how many bits are still in the box.



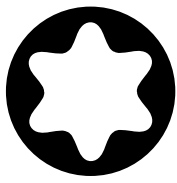

Bits for TORX® Screws



1/4" hexagon drive, suitable for D 6,3 bit holders (series 1)

867/1 TORX® bits



Application: TORX® socket screws

Drive: 1/4" hexagon, suitable for DIN ISO 1173-D 6,3 bit holders

Design: Tough, for universal use

		□ mm	□ "	∅ mm
05135140001	TX 1	25	1"	1,5
05135141001	TX 2	25	1"	1,5
05135142001	TX 3	25	1"	2,0
05135143001	TX 4	25	1"	2,0
05066492001	TX 5	25	1"	3,0
05066493001	TX 6	25	1"	3,0
05066494001	TX 7	25	1"	3,0
05066495001	TX 8	25	1"	3,0
05066496001	TX 9	25	1"	3,0
05066485001	TX 10	25	1"	4,0
05066486001	TX 15	25	1"	4,0
05066487001	TX 20	25	1"	5,0
05066488001	TX 25	25	1"	5,0
05066489001	TX 27	25	1"	6,0
05066490001	TX 30	25	1"	6,0
05066491001	TX 40	25	1"	-
05066325001	TX 45	35	1 3/8"	8,0
05066330001	TX 50	35	1 3/8"	9,0
05066335001	TX 55	35	1 3/8"	12,0

Bit-Box 20 TX

			4013288
05057770001	⊗	867/1 TORX® 20 x TX 20x25	187994
05057773001	⊗	867/1 TORX® 20 x TX 25x25	188007



867/1 SB TORX® bits

			4013288
05073313001	⊗	2 x TX 10x25	029140
05073340001	⊗	2 x TX 15x25	029591
05073314001	⊗	2 x TX 20x25	029157
05073315001	⊗	2 x TX 25x25	029164
05073316001	⊗	2 x TX 30x25	029171
05073317001	⊗	2 x TX 40x25	029188
05073346001	⊗	1 x TX 50x35	125859
05073375001	⊗	1 x TX 10x25; 1 x TX 15x25; 1 x TX 20x25	037503
05073376001	⊗	1 x TX 25x25; 1 x TX 30x25; 1 x TX 40x25	037510



867/1 TORX® bits DIY

			4013288
05072406001	⊗	10 x TX 10x25	115799
05072407001	⊗	10 x TX 15x25	115805
05072408001	⊗	10 x TX 20x25	115812
05072409001	⊗	10 x TX 25x25	115829
05072410001	⊗	10 x TX 27x25	115836
05072411001	⊗	10 x TX 30x25	115843
05072412001	⊗	10 x TX 40x25	115850



867/1 TORX® bits DIY 100

			4013288
05072446001	⊗	100 x TX 10x25	138507
05072447001	⊗	100 x TX 15x25	138514
05072448001	⊗	100 x TX 20x25	138521
05072449001	⊗	100 x TX 25x25	138538
05072450001	⊗	100 x TX 27x25	138545
05072451001	⊗	100 x TX 30x25	138552
05072452001	⊗	100 x TX 40x25	138569



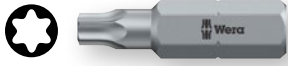

867/1 Z TORX® Wedge bits



Application: TORX® socket screws

Drive: 1/4" hexagon, suitable for DIN ISO 1173-D 6,3 bit holders

Design: W = Wedge TORX®, tough, for universal use

		 mm	 "
05066450001	TX 10	25	1"
05066455001	TX 15	25	1"
05066460001	TX 20	25	1"
05066465001	TX 25	25	1"
05066470001	TX 27	25	1"
05066475001	TX 30	25	1"
05066480001	TX 40	25	1"



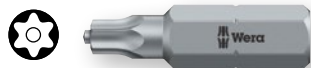

867/1 ZA TORX® bits with central pin



Application: SPAX T-STAR plus screws

Drive: 1/4" hexagon, suitable for DIN ISO 1173-D 6,3 bit holders

Design: Central pin, tough, for universal use

		 mm	 "	 mm
05066080001	TX 10	25	1"	4,0
05066081001	TX 15	25	1"	4,0
05066082001	TX 20	25	1"	5,0
05066083001	TX 25	25	1"	5,0
05066084001	TX 30	25	1"	6,0
05066085001	TX 40	25	1"	-

Tip

TORX® Wedge

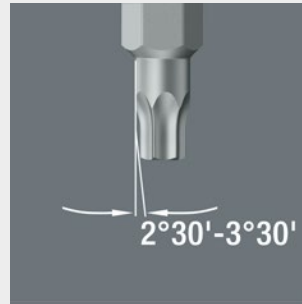

The conical TORX® profile provides a better fit in the screw. Combined with a great recess depth this produces a pinch effect.

TORX® bits with central pin



The protruding pin that fits into the borehole of the screw makes it easier to centre the tool in the screw recess.

Bit-Box

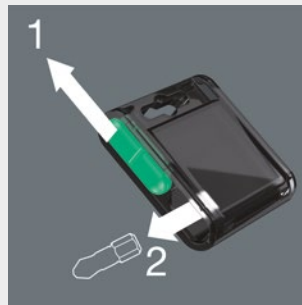

The slide switch allows a simple and gradual removal and reinsertion of the bits. The transparent reverse side means that it is easy to know how many bits are still in the box.



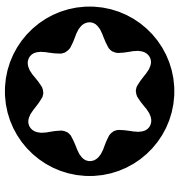

Bits for TORX® Screws



1/4" hexagon drive, suitable for F 6,3 bit holders (series 4)

867/4 IMP DC Impaktor TORX® bits



Application: TORX® socket screws

Drive: 1/4" hexagon, suitable for DIN ISO 1173-F 6,3 bit holders

Design: The Impaktor technology ensures an above-average service life even under extreme conditions thanks to a best-possible utilisation of the material properties and optimally designed geometry, particularly suitable for use with conventional impact drivers, the rough diamond coating reduces the danger of any slipping out of the screw head due to the enhanced frictional resistance. Take it easy toolfinder: Output colour coding (green = TORX®) and large stamp to enable the desired bit to be easily located.

		⌀ mm	ℓ "
05057664001	TX 20	50	2"
05057665001	TX 25	50	2"
05057666001	TX 30	50	2"
05057667001	TX 40	50	2"

867/4 IMP DC SB Impaktor bits

		ℓ "	ℓ mm
05073964001	1 x TX 20x50	163257	4013288
05073965001	1 x TX 25x50	158529	
05073966001	1 x TX 30x50	158536	
05073967001	1 x TX 40x50	158543	



3867/4 TORX®, stainless



Application: TORX® socket screws

Drive: 1/4" hexagon, suitable for DIN ISO 1173-F 6,3 bit holders

Design: Stainless steel for minimising rust
Take it easy toolfinder: Output colour coding (green = TORX®) and large stamp to enable the desired bit to be easily located.

		⌀ mm	ℓ "
05071046001	TX 20	50	2"
05071047001	TX 25	50	2"

867/4 KK TORX® bits



Application: TORX® socket screws

Drive: 1/4" hexagon, suitable for DIN ISO 1173-F 6,3 bit holders

Design: Ball end, tough, for universal use

		⌀ mm	ℓ "
05059700001	TX 10	89	3 1/2"
05059701001	TX 15	89	3 1/2"
05059702001	TX 20	89	3 1/2"
05059703001	TX 25	89	3 1/2"
05059704001	TX 30	89	3 1/2"
05059705001	TX 40	89	3 1/2"





867/4 TORX® HF bits with holding function



Application: TORX® socket screws

Drive: 1/4" hexagon, suitable for DIN ISO 1173-F 6,3 bit holders

Design: Holding function for TORX® screws made according to Acument Intellectual Properties specifications, tough, for universal use

		 mm	 mm	 mm
05060080001	TX 8	50	2"	3,0
05060360001	TX 10	89	3 1/2"	4,0
05060081001	TX 10	50	2"	4,0
05060361001	TX 15	89	3 1/2"	4,0
05060082001	TX 15	50	2"	4,0
05060362001	TX 20	89	3 1/2"	4,5
05060083001	TX 20	50	2"	4,5
05060084001	TX 25	50	2"	6,0
05060363001	TX 25	89	3 1/2"	6,0
05060085001	TX 27	50	2"	6,0
05060364001	TX 27	89	3 1/2"	6,0
05060086001	TX 30	50	2"	6,0
05060365001	TX 30	89	3 1/2"	6,0
05060087001	TX 40	50	2"	-
05060366001	TX 40	89	3 1/2"	-





867/4 H TORX® bits



Application: TORX® socket screws

Drive: 1/4" hexagon, suitable for DIN ISO 1173-F 6.3 bit holders

Design: Extra-hard

		 mm	 mm	 mm
05135170001	TX 5	50	2"	3,0
05135171001	TX 5	70	2 3/4"	3,0
05135172001	TX 6	50	2"	3,0
05135180001	TX 6	70	2 3/4"	3,0
05135174001	TX 8	50	2"	3,0
05135182001	TX 8	70	2 3/4"	3,0
05135176001	TX 10	50	2"	4,0
05135184001	TX 10	70	2 3/4"	4,0
05135185001	TX 15	50	2"	4,0
05135186001	TX 15	70	2 3/4"	4,0

Tip



TORX® ball tip



The spherical drive profile means that it is possible to swivel the axis of the tool to that of the screw, and therefore enable angled, "around-the-corner" screwdriving jobs.



The HF profile



In tight assembly or disassembly situations, for example in engine compartments, it is not possible to securely hold the screw with the hand on the screwdriver, and the screw subsequently often gets lost. Lengthy searches or the loss of the screw (with the associated danger that could bring about) are the consequence. The HF tools developed by Wera are ideal because they feature an optimised geometry of the original TORX® profile. The wedging forces resulting from the surface pressure between the drive tip and the screw profile mean that the screw is securely held on the tool!

867/4 H: A vacuum-hardened bit



Vacuum hardening is the cleanest and most environmentally friendly of all hardening methods. The environment inside the vacuum chamber is unreactive, even to alloys which are especially prone to oxidation. For all grades of steel, vacuum heat treatment is the optimum heat treatment, and represents state of the art technology.



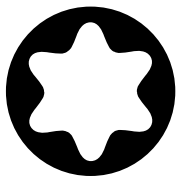

Bits for TORX® Screws

 1/4" hexagon drive, suitable for F 6,3 bit holders (series 4)

867/4 Z TORX® bits





Application: TORX® socket screws

Drive: 1/4" hexagon, suitable for DIN ISO 1173-F 6,3 bit holders

Design: For universal use



		l, mm	l, "	∅ mm
05135200001	TX 1	50	2"	2,0
05135201001	TX 2	50	2"	2,0
05135202001	TX 3	50	2"	2,0
05135204001	TX 4	50	2"	3,0
05135205001	TX 5	50	2"	3,0
05308428001	TX 6	50	2"	3,0
05134740001	TX 6	70	2 3/4"	3,0
05332600001	TX 6	89	3 1/2"	3,0
05328448001	TX 6	152	6"	3,0
05160830001	TX 7	50	2"	3,0
05345047001	TX 7	70	2 3/4"	3,0
05060131001	TX 8	50	2"	3,0
05060098001	TX 8	70	2 3/4"	3,0
05060185001	TX 8	89	3 1/2"	3,0
05060195001	TX 8	152	6"	3,0
05319835001	TX 9	70	2 3/4"	3,0
05060193001	TX 9	89	3 1/2"	3,0
05060194001	TX 9	152	6"	3,0
05060132001	TX 10	50	2"	4,0
05060100001	TX 10	70	2 3/4"	4,0
05060186001	TX 10	89	3 1/2"	4,0
05060196001	TX 10	152	6"	4,0
05060133001	TX 15	50	2"	4,0
05060105001	TX 15	70	2 3/4"	4,0
05060187001	TX 15	89	3 1/2"	4,0
05060197001	TX 15	152	6"	4,0
05060134001	TX 20	50	2"	4,5
05060110001	TX 20	70	2 3/4"	4,5
05060188001	TX 20	89	3 1/2"	4,5
05060198001	TX 20	152	6"	4,5
05060135001	TX 25	50	2"	6,0
05060115001	TX 25	70	2 3/4"	6,0
05060189001	TX 25	89	3 1/2"	6,0
05060199001	TX 25	152	6"	6,0
05060136001	TX 27	50	2"	6,0
05060120001	TX 27	70	2 3/4"	6,0
05060190001	TX 27	89	3 1/2"	6,0
05060200001	TX 27	152	6"	6,0
05060137001	TX 30	50	2"	6,0
05060125001	TX 30	70	2 3/4"	6,0
05060191001	TX 30	89	3 1/2"	6,0
05060201001	TX 30	152	6"	6,0
05060138001	TX 40	50	2"	-
05060130001	TX 40	70	2 3/4"	-
05060192001	TX 40	89	3 1/2"	-
05060202001	TX 40	152	6"	-

867/4 SB TORX® bits, 89 mm

		
		4013288
05073526001	1 x TX 10x89	105929
05073527001	1 x TX 15x89	105936
05073528001	1 x TX 20x89	105943
05073529001	1 x TX 25x89	105950
05073530001	1 x TX 30x89	105967
05073531001	1 x TX 40x89	105974



867/4 SB TORX® bits, 50 mm

		
		4013288
05073720001	2 x TX 10x50	132789
05073721001	2 x TX 15x50	132796
05073722001	2 x TX 20x50	132802
05073723001	2 x TX 25x50	132826
05073724001	2 x TX 30x50	132833





5/16" hexagon drive, suitable for D 8 bit holders or direct drive (series 2)

867/2 Z TORX® bits



Application: TORX® socket screws

Drive: 5/16" hexagon, suitable for DIN ISO 1173-D 8 bit holders

Design: Tough, for universal use

		 mm	 "	 mm
05066901001	TX 20	35	1 3/8"	4,5
05066930001	TX 20	50	2"	4,5
05066945001	TX 20	70	2 3/4"	4,5
05066935001	TX 20	100	4"	4,5
05066900001	TX 25	35	1 3/8"	5,8
05066931001	TX 25	50	2"	5,8
05066946001	TX 25	70	2 3/4"	5,8
05066936001	TX 25	100	4"	5,8
05066902001	TX 27	35	1 3/8"	5,8
05066932001	TX 27	50	2"	5,8
05066937001	TX 27	100	4"	5,8
05066905001	TX 30	35	1 3/8"	6,0
05066933001	TX 30	50	2"	6,0
05066947001	TX 30	70	2 3/4"	6,0
05066938001	TX 30	100	4"	6,0
05066910001	TX 40	35	1 3/8"	7,0
05066934001	TX 40	50	2"	7,0
05066948001	TX 40	70	2 3/4"	7,0
05066939001	TX 40	100	4"	7,0
05066915001	TX 45	35	1 3/8"	-
05066940001	TX 45	50	2"	-
05066949001	TX 45	70	2 3/4"	-
05066942001	TX 45	100	4"	-
05066920001	TX 50	35	1 3/8"	-
05066941001	TX 50	50	2"	-
05066950001	TX 50	70	2 3/4"	-
05066943001	TX 50	100	4"	-
05066925001	TX 55	35	1 3/8"	12,0
05136220001	TX 60	35	1 3/8"	14,0



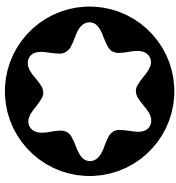

Bits for TORX® Screws



M 4 Thread drive M 4 direct drive (series 11)



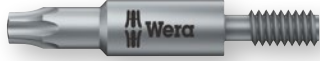

867/11 TORX® bits



Application: TORX® screws

Drive: Thread drive M 4

Design: Tough, for universal use

		 mm	 mm	 mm
05064140001	TX 8	33	1 1/4"	6,0
05064144001	TX 10	33	1 1/4"	6,0
05064146001	TX 15	33	1 1/4"	6,0



M 5 Thread drive M 5 direct drive (series 12)





867/12 TORX® bits



Application: TORX® socket screws

Drive: Thread drive M 5

Design: Tough, for universal use





		 mm	 mm	 mm
05064148001	TX 10	45	1 3/4"	6,0
05064150001	TX 15	45	1 3/4"	6,0
05064155001	TX 20	45	1 3/4"	6,0
05064160001	TX 25	45	1 3/4"	6,0

 M 6 Thread drive M 6 direct drive (series 15)

867/15 TORX® bits



Application: TORX® screws
Drive: Thread drive M 6
Design: Tough, for universal use





		 mm	 "	 mm
05064166001	TX 10	45	1 3/4"	8,0
05064168001	TX 15	45	1 3/4"	8,0
05064170001	TX 20	45	1 3/4"	8,0
05064175001	TX 25	45	1 3/4"	8,0
05064180001	TX 30	45	1 3/4"	8,0

 #10/32" Thread drive #10-32 UNF direct drive (series 16)

867/16 TORX® bits



Application: TORX® screws
Drive: Thread drive #10-32 UNF
Design: Tough, for universal use

		 mm	 "	 mm
05064185001	TX 10	45	1 3/4"	6,0
05064190001	TX 15	45	1 3/4"	6,0
05064200001	TX 20	45	1 3/4"	6,0



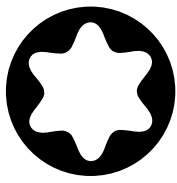

Bits for TORX® Screws







4 mm 4 mm Halfmoon direct drive (series 9)

867/9 C TORX® bits, halfmoon



Application: TORX® socket screws
Drive: Halfmoon, 4 mm
Design: Precision hardened for sensitive applications

		 mm	 mm	 mm
05135220001	TX 1	44	1 ⁴⁷ / ₆₄ "	1,5
05135221001	TX 2	44	1 ⁴⁷ / ₆₄ "	1,5
05135222001	TX 3	44	1 ⁴⁷ / ₆₄ "	1,7
05345352001	TX 4	44	1 ⁴⁷ / ₆₄ "	1,8
05345018001	TX 4	64	2 ³³ / ₆₄ "	2,0
05345351001	TX 5	44	1 ⁴⁷ / ₆₄ "	3,0
05345032001	TX 5	64	2 ³³ / ₆₄ "	2,0
05314753001	TX 5	70	2 ³ / ₄ "	2,0
05345350001	TX 6	44	1 ⁴⁷ / ₆₄ "	3,0
05345056001	TX 6	64	2 ³³ / ₆₄ "	2,0
05332610001	TX 6	70	2 ³ / ₄ "	3,0
05345035001	TX 7	64	2 ³³ / ₆₄ "	2,3
05345026001	TX 8	44	1 ⁴⁷ / ₆₄ "	3,0
05345028001	TX 8	64	2 ³³ / ₆₄ "	3,0
05332609001	TX 8	70	2 ³ / ₄ "	3,0
05332607001	TX 10	70	2 ³ / ₄ "	3,0









4 mm 4 mm HIOS direct drive (series 21)

867/21 TORX® bits



Application: TORX® socket screws
Drive: HIOS 4 mm
Design: Precision hardened for sensitive applications

		 mm	 mm	 mm	 mm	 mm
05135400001 ¹⁾	TX 1	40	1 ⁹ / ₁₆ "	1,5	20	²⁵ / ₃₂ "
05135401001 ¹⁾	TX 2	40	1 ⁹ / ₁₆ "	1,5	20	²⁵ / ₃₂ "
05135402001 ¹⁾	TX 3	40	1 ⁹ / ₁₆ "	1,7	20	²⁵ / ₃₂ "
05135403001	TX 4	40	1 ⁹ / ₁₆ "	1,8	20	²⁵ / ₃₂ "
05135404001	TX 5	40	1 ⁹ / ₁₆ "	2,0	20	²⁵ / ₃₂ "
05135405001	TX 6	40	1 ⁹ / ₁₆ "	2,0	20	²⁵ / ₃₂ "
05135406001	TX 7	40	1 ⁹ / ₁₆ "	2,5	20	²⁵ / ₃₂ "
05135407001	TX 8	40	1 ⁹ / ₁₆ "	3,0	20	²⁵ / ₃₂ "
05135408001	TX 9	40	1 ⁹ / ₁₆ "	3,0	20	²⁵ / ₃₂ "
05135409001	TX 10	40	1 ⁹ / ₁₆ "	3,0	20	²⁵ / ₃₂ "

¹⁾ Delivery on request.









 5 mm 5 mm HIOS direct drive (series 22)

867/22 TORX® bits



Application: TORX® screws
Drive: HIOS 5 mm
Design: Tough, for universal use

		 mm	 mm	 mm	 mm	 mm
05135420001	TX 5	60	2 3/8"	2,0	20	25/32"
05135421001	TX 6	60	2 3/8"	2,5	20	25/32"
05135422001	TX 7	60	2 3/8"	2,5	20	25/32"
05135423001	TX 8	60	2 3/8"	3,0	20	25/32"
05135424001	TX 9	60	2 3/8"	3,0	20	25/32"
05135425001	TX 10	60	2 3/8"	3,0	20	25/32"



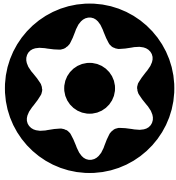

Bits for Tamper-proof TORX® BO Screws with safety pin



1/4" hexagon drive, suitable for D 6,3 bit holders (series 1)

867/1 Z TORX® BO bits



Application: TORX® socket screws with safety pin (BO = with bore hole)

Drive: 1/4" hexagon, suitable for DIN ISO 1173-D 6,3 bit holders

Design: TORX® with bore hole, tough, for universal use

		1/4" mm	1/4"
05066497001	TX 7	25	1"
05066498001	TX 8	25	1"
05066499001	TX 9	25	1"
05066500001	TX 10	25	1"
05066505001	TX 15	25	1"
05066510001	TX 20	25	1"
05066515001	TX 25	25	1"
05066520001	TX 27	25	1"
05066525001	TX 30	25	1"
05066530001	TX 40	25	1"



1/4" hexagon drive, suitable for F 6,3 bit holders (series 4)

3867/4 TORX® BO bits with bore hole, stainless



Application: TORX® socket screws with safety pin (BO = with bore hole)

Drive: 1/4" hexagon, suitable for DIN ISO 1173-F 6,3 bit holders

Design: Stainless steel for minimising rust

		□, mm	□, mm	∅ mm
05071089001	TX 10 BO	89	3 1/2"	4,0
05071090001	TX 15 BO	89	3 1/2"	4,0
05071091001	TX 20 BO	89	3 1/2"	4,5
05071092001	TX 25 BO	89	3 1/2"	5,5
05071094001	TX 30 BO	89	3 1/2"	6,0

867/4 Z TORX® BO bits with bore hole



Application: TORX® socket screws with safety pin (BO = with bore hole)

Drive: 1/4" hexagon, suitable for DIN ISO 1173-F 6,3 bit holders

Design: TORX® with bore hole, tough, for universal use

		□, mm	□, mm	∅ mm
05060139001	TX 8	70	2 3/4"	3,0
05060048001	TX 8	89	3 1/2"	3,0
05060049001	TX 9	89	3 1/2"	3,0
05060140001	TX 10	70	2 3/4"	4,0
05060050001	TX 10	89	3 1/2"	4,0
05060141001	TX 15	70	2 3/4"	4,0
05060051001	TX 15	89	3 1/2"	4,0
05060142001	TX 20	70	2 3/4"	4,5
05060052001	TX 20	89	3 1/2"	4,5
05060143001	TX 25	70	2 3/4"	6,0
05060053001	TX 25	89	3 1/2"	6,0
05060144001	TX 27	70	2 3/4"	6,0
05060057001	TX 27	89	3 1/2"	6,0
05060145001	TX 30	70	2 3/4"	6,0
05060054001	TX 30	89	3 1/2"	6,0
05060146001	TX 40	70	2 3/4"	-
05060056001	TX 40	89	3 1/2"	-



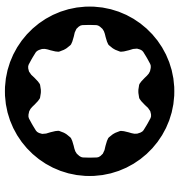

Bits for TORX PLUS® Screws



1/4" hexagon drive, suitable for D 6,3 bit holders (series 1)

867/1 IP TORX PLUS® bits

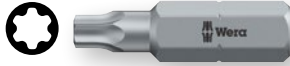

Application: TORX PLUS® socket screws

Drive: 1/4" hexagon, suitable for DIN ISO 1173-D 6,3 bit holders

Design: Tough, for universal use

		□, mm	□, "
05135120001	1 IP	25	1"
05135121001	2 IP	25	1"
05160956001	3 IP	25	1"
05134695001	4 IP	25	1"
05066272001	5 IP	25	1"
05066274001	6 IP	25	1"
05066276001	7 IP	25	1"
05066278001	8 IP	25	1"
05066279001	9 IP	25	1"
05066280001	10 IP	25	1"
05066282001	15 IP	25	1"
05066284001	20 IP	25	1"
05066286001	25 IP	25	1"
05066287001	27 IP	25	1"
05066288001	30 IP	25	1"
05066290001	40 IP	25	1"



1/4" hexagon drive, suitable for F 6,3 bit holders (series 4)





867/4 IP TORX PLUS® bits



Application: TORX PLUS® socket screws

Drive: 1/4" hexagon, suitable for DIN ISO 1173-F 6,3 bit holders

Design: Tough, for universal use

		 mm	 "	 mm
05134664001	1 IP	50	2"	2,0
05134665001	2 IP	50	2"	2,0
05134668001	3 IP	50	2"	2,0
05134691001	4 IP	50	2"	3,0
05134678001	5 IP	50	2"	3,0
05134680001	6 IP	50	2"	3,0
05134667001	6 IP	89	3 1/2"	3,0
05134690001	6 IP	152	6"	3,0
05134681001	7 IP	50	2"	3,0
05134679001	8 IP	50	2"	3,0
05134670001	8 IP	89	3 1/2"	3,0
05134682001	8 IP	152	6"	3,0
05160917001	9 IP	50	2"	3,0
05134669001	9 IP	89	3 1/2"	3,0
05134683001	10 IP	50	2"	4,0
05134684001	10 IP	70	2 3/4"	4,0
05134671001	10 IP	89	3 1/2"	4,0
05134685001	15 IP	50	2"	4,0
05134686001	15 IP	70	2 3/4"	4,0
05134672001	15 IP	89	3 1/2"	4,0
05134687001	20 IP	50	2"	4,5
05134688001	20 IP	70	2 3/4"	4,5
05134673001	20 IP	89	3 1/2"	4,5
05134674001	25 IP	89	3 1/2"	6,0
05134675001	27 IP	89	3 1/2"	6,0
05320430001	30 IP	50	2"	6,0
05134676001	30 IP	89	3 1/2"	6,0
05134677001	40 IP	89	3 1/2"	-



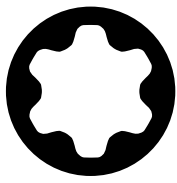







Bits for TORX PLUS® Screws

 4 mm 4 mm Halfmoon direct drive (series 9)

867/9 C IP TORX PLUS® bits, halfmoon



Application: TORX PLUS® screws
Drive: Halfmoon, 4 mm
Design: Precision hardened for sensitive applications







		 mm	 "	 mm	 mm	 "
05135230001	1 IP	44	1 ⁴⁷ / ₆₄	1,5	20	²⁵ / ₃₂
05135231001	2 IP	44	1 ⁴⁷ / ₆₄	1,5	20	²⁵ / ₃₂
05135232001	3 IP	44	1 ⁴⁷ / ₆₄	1,7	20	²⁵ / ₃₂
05326310001	4 IP	44	1 ⁴⁷ / ₆₄	2,0	20	²⁵ / ₃₂
05345019001	4 IP	64	2 ³³ / ₆₄	2,0	20	²⁵ / ₃₂
05135233001	5 IP	44	1 ⁴⁷ / ₆₄	2,0	20	²⁵ / ₃₂
05332612001	5 IP	70	2 ³ / ₄	3,0	20	²⁵ / ₃₂
05344900001	6 IP	44	1 ⁴⁷ / ₆₄	2,25	20	²⁵ / ₃₂
05135234001	8 IP	44	1 ⁴⁷ / ₆₄	3,0	20	²⁵ / ₃₂
05332606001	8 IP	70	2 ³ / ₄	3,0	20	²⁵ / ₃₂
05135235001	10 IP	44	1 ⁴⁷ / ₆₄	3,0	20	²⁵ / ₃₂

 4 mm 4 mm HIOS direct drive (series 21)

867/21 IP TORX PLUS® bits



Application: TORX PLUS® screws
Drive: HIOS 4 mm
Design: Precision hardened for sensitive applications

		 mm	 "	 mm	 mm	 "
05135430001 ¹⁾	1 IP	40	1 ⁹ / ₁₆	1,5	20	²⁵ / ₃₂
05135431001 ¹⁾	2 IP	40	1 ⁹ / ₁₆	1,5	20	²⁵ / ₃₂
05135432001 ¹⁾	3 IP	40	1 ⁹ / ₁₆	1,7	20	²⁵ / ₃₂
05302402001	4 IP	40	1 ⁹ / ₁₆	1,8	20	²⁵ / ₃₂
05302403001	5 IP	40	1 ⁹ / ₁₆	2,0	20	²⁵ / ₃₂
05302400001	6 IP	40	1 ⁹ / ₁₆	2,0	20	²⁵ / ₃₂
05135433001	7 IP	40	1 ⁹ / ₁₆	2,5	20	²⁵ / ₃₂
05135434001	8 IP	40	1 ⁹ / ₁₆	3,0	20	²⁵ / ₃₂
05135435001	9 IP	40	1 ⁹ / ₁₆	3,0	20	²⁵ / ₃₂
05135436001	10 IP	40	1 ⁹ / ₁₆	3,0	20	²⁵ / ₃₂







¹⁾ Delivery on request.

 5 mm 5 mm HIOS direct drive (series 22)

867/22 IP TORX PLUS® bits



Application: TORX PLUS® screws
Drive: HIOS 5 mm
Design: Precision hardened for sensitive applications

		 mm	 "	 mm	 mm	 "
05135440001	5 IP	60	2 ³ / ₈	2,0	20	²⁵ / ₃₂
05344280001	6 IP	60	2 ³ / ₈	2,5	20	²⁵ / ₃₂
05135441001	7 IP	60	2 ³ / ₈	2,5	20	²⁵ / ₃₂
05134500001	8 IP	60	2 ³ / ₈	3,0	20	²⁵ / ₃₂
05344281001	8 IP	80	3 ¹ / ₈	3,0	20	²⁵ / ₃₂
05135442001	9 IP	60	2 ³ / ₈	3,0	20	²⁵ / ₃₂
05135443001	10 IP	60	2 ³ / ₈	3,0	20	²⁵ / ₃₂
05344282001	10 IP	80	3 ¹ / ₈	3,0	20	²⁵ / ₃₂



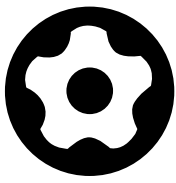

Bits for Tamper-proof TORX PLUS® IPR Screws



1/4" hexagon drive, suitable for D 6,3 bit holders (series 1)

867/1 IPR TORX PLUS® bits with bore hole



Application: TORX PLUS® IPR socket screws with safety pin

Drive: 1/4" hexagon, suitable for DIN ISO 1173-D 6,3 bit holders

Design: Tough, for universal use

		 mm	
05134699001	8 IPR	25	1"
05134698001	9 IPR	25	1"
05134700001	10 IPR	25	1"
05134701001	15 IPR	25	1"
05134702001	20 IPR	25	1"
05134703001	25 IPR	25	1"
05134704001	27 IPR	25	1"
05134705001	30 IPR	25	1"
05134706001	40 IPR	35	1 3/8"
05134707001	45 IPR	35	1 3/8"





1/4" hexagon drive, suitable for F 6,3 bit holders (series 4)

867/4 IPR TORX PLUS® bits with bore hole



Application: TORX PLUS® IPR socket screws with safety pin

Drive: 1/4" hexagon, suitable for DIN ISO 1173-F 6,3 bit holders

Design: Tough, for universal use

		l, mm	l, "	∅ mm
05134600001 ¹⁾	1 IPR	50	2"	2,0
05134601001 ¹⁾	3 IPR	50	2"	2,0
05134602001 ¹⁾	5 IPR	50	2"	3,0
05134603001 ¹⁾	6 IPR	50	2"	3,0
05134604001	8 IPR	50	2"	3,0
05160821001	10 IPR	50	2"	4,0
05134657001	10 IPR	89	3 1/2"	4,0
05134654001	15 IPR	50	2"	4,0
05134720001	15 IPR	89	3 1/2"	4,0
05204126001	20 IPR	50	2"	4,5
05259135001	20 IPR	89	3 1/2"	4,5
05134655001	25 IPR	50	2"	6,0
05134722001	25 IPR	89	3 1/2"	6,0
05134656001	27 IPR	50	2"	6,0
05134658001	27 IPR	89	3 1/2"	6,0
05134732001	30 IPR	50	2"	6,0
05134723001	30 IPR	89	3 1/2"	6,0

¹⁾ Without bore hole



4 mm 4 mm Halfmoon direct drive (series 9)

867/9 IPR TORX PLUS® bits



Application: TORX PLUS® IPR socket screws

Drive: Halfmoon, 4 mm

Design: Tough, for universal use

		l, mm	l, "	∅ mm
05200495001	1 IPR	44	1 47/64"	1,5
05060380001	1 IPR	44	1 47/64"	1,8
05135226001	1 IPR	64	2 33/64"	1,5
05135228001	3 IPR	44	1 47/64"	1,8
05135229001	3 IPR	64	2 33/64"	1,8



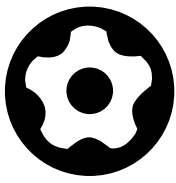

Bits for Tamper-proof TORX PLUS® IPR Screws

 4 mm 4 mm HIOS direct drive (series 21)





867/21 IPR TORX PLUS® bits



Application: TORX PLUS® IPR socket screws

Drive: HIOS 4 mm

Design: Tough, for universal use

		 mm	 mm	 mm
05300025001	1 IPR	40	1 ³⁷ / ₆₄ "	1,8
05300037001	1 IPR	60	2 ³ / ₈ "	1,8

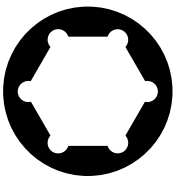

Bits for ASSY® Screws

1/4" hexagon drive, suitable for D 6,3 bit holders (series 1)

864/1 BTZ SIT bits



Application: ASSY® screws

Drive: 1/4" hexagon, suitable for DIN ISO 1173-D 6,3 bit holders

Design: BiTorsion for long service life, extra-tough, for universal use

		 mm	 "
05066040001	SIT 10	25	1"
05066041001	SIT 20	25	1"
05066042001	SIT 25	25	1"
05066043001	SIT 30	25	1"

864/1 Z SIT bits



Application: ASSY® screws

Drive: 1/4" hexagon, suitable for DIN ISO 1173-D 6,3 bit holders

Design: Tough, for universal use

		 mm	 "
05066030001	SIT 10	25	1"
05066031001	SIT 20	25	1"
05066032001	SIT 25	25	1"
05066033001	SIT 30	25	1"



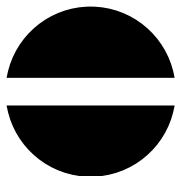

Bits for Slotted Screws



1/4" hexagon drive, suitable for D 6,3 bit holders (series 1)

3800/1 TS bits for slotted screws, stainless



Application: Slotted screws

Drive: 1/4" hexagon, suitable for DIN ISO 1173-D 6,3 bit holders

Design: Stainless steel for minimising rust, special torsion-style design to reduce premature wear. Take it easy toolfinder: Output colour coding (yellow = slotted) and large stamp to enable the desired bit to be easily located.

	mm	mm	mm	"
05071000001	0,8	5,5	25	1"
05071001001	1,0	5,5	25	1"
05071002001	1,2	6,5	25	1"

800/1 BTZ bits



Application: Slotted screws

Drive: 1/4" hexagon, suitable for DIN ISO 1173-D 6,3 bit holders

Design: BiTorsion for long service life, extra-tough, for universal use. Take it easy toolfinder: Output colour coding (yellow = slotted) and large stamp to enable the desired bit to be easily located.

	mm	mm	mm	"
05056064001	0,8	5,5	25	1"
05056066001	1,0	5,5	25	1"
05056068001	1,2	6,5	25	1"

800/1 BDC bits



Application: Slotted screws

Drive: 1/4" hexagon, suitable for DIN ISO 1173-D 6,3 bit holders

Design: BiTorsion for long service life, diamond-coated for secure screw fit. Take it easy toolfinder: Output colour coding (yellow = slotted) and large stamp to enable the desired bit to be easily located.

	mm	mm	mm	"
05056172001	0,8	5,5	25	1"
05056174001	1,0	5,5	25	1"
05056176001	1,2	6,5	25	1"

800/1 TZ bits



Application: Slotted screws

Drive: 1/4" hexagon, suitable for DIN ISO 1173-D 6,3 bit holders

Design: Torsion-style design to reduce premature wear, tough, for universal use

	mm	mm	mm	"	mm
05056203001	0,5	4,0	25	1"	4,0
05056210001	0,6	4,5	25	1"	4,5
05056220001	0,8	5,5	25	1"	5,5
05056225001	1,0	5,5	25	1"	5,5
05056233001	1,2	6,5	25	1"	6,2
05056240001	1,6	8,0	25	1"	8,0

800/1 Z bits

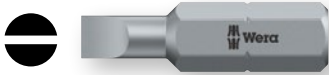

Application: Slotted screws

Drive: 1/4" hexagon, suitable for DIN ISO 1173-D 6,3 bit holders

Design: Tough, for universal use

	√ mm	√ mm	√ mm	√ mm	∅ mm
05056200001	0,5	3,0	25	1"	3,0
05056005001	0,5	3,0	39	1 17/32"	3,0
05072050001	0,5	4,0	25	1"	4,0
05056007001	0,5	4,0	39	1 17/32"	4,0
05056010001	0,6	3,5	39	1 17/32"	3,5
05072055001	0,6	4,5	25	1"	4,5
05056015001	0,6	4,5	39	1 17/32"	4,5
05072057001	0,8	5,5	25	1"	5,5
05056020001	0,8	4,0	39	1 17/32"	4,0
05056025001	0,8	5,5	39	1 17/32"	5,5
05072059001	1,0	5,5	25	1"	5,5
05056030001	1,0	5,5	39	1 17/32"	5,5
05072061001	1,2	6,5	25	1"	6,2
05072063001	1,2	8,0	25	1"	8,0
05056037001	1,2	6,5	39	1 17/32"	6,5
05056040001	1,2	8,0	39	1 17/32"	8,0
05072065001	1,6	8,0	25	1"	8,0
05056045001	1,6	8,0	39	1 17/32"	8,0

800/1 Z Set SB

		4013288
05073300001	1 x 0.6x4.5x25; 1 x 0.8x5.5x25	029010
05073301001	1 x 1.0x5.5x25; 1 x 1.2x6.5x25	029027
05073302001	1 x 0.6x4.5x25; 1 x 1.0x5.5x25; 1 x 1.2x6.5x25	029034



800/1 Z Set D

		4013288
05073303001	1 x 1.0x5.5x25	029041
	1 x PH 2x25	
	1 x PZ 2x25	



Tip



Stainless Steel Bits



Wera stainless steel bits are manufactured out of stainless steel so unsightly rust can be avoided. The stainless steel bits from Wera are vacuum ice-hardened and have the hardness and strength needed for screw connections. There are no limitations to the industrial applications they are suitable for.



BDC-Bits



BDC-Bits are absolutely premium products. They have a softer BiTorsion zone which reduces the hardness of the shaft by about 20 % in comparison to the drive tip. This means that the peak loads that cause bit breakage and premature wear are absorbed in this zone – something which enhances the service life of the bits.

The diamond coating lowers the danger of slipping as the minute diamond particles literally "bite" themselves into the screw head. B stands for BiTorsion. DC stands for diamond coated.



"Take it easy"

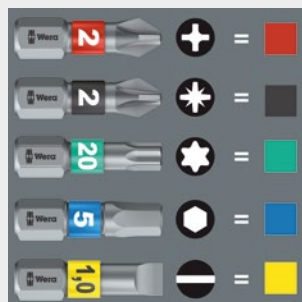

"Take it easy" tool finder with colour coding according to profiles and size stamp – for simple and rapid accessing of the required tool.



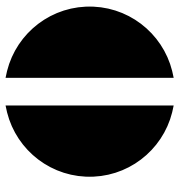

Bits for Slotted Screws



1/4" hexagon drive, suitable for F 6,3 bit holders (series 4)

3800/4 Bits for slotted screws, stainless



Application: Slotted screws

Drive: 1/4" hexagon, suitable for DIN ISO 1173-F 6,3 bit holders

Design: Stainless steel for minimising rust

	┘ mm	┘ mm	┘ mm	┘ mm
05071080001	1,0	5,5	89	3 1/2"

800/4 Z bits



Application: Slotted screws

Drive: 1/4" hexagon, suitable for DIN ISO 1173-F 6,3 bit holders

Design: Tough, for universal use

	┘ mm	┘ mm	┘ mm	┘ "	∅ mm
05059305001	0,5	3,0	50	2"	3,0
05059466001	0,5	3,0	70	2 3/4"	3,0
05059307001	0,5	4,0	50	2"	4,0
05059310001	0,6	3,5	50	2"	3,5
05059472001	0,6	3,5	70	2 3/4"	3,5
05059450001	0,6	3,5	152	6"	3,5
05059315001	0,6	4,5	50	2"	4,5
05059489001	0,6	4,5	89	3 1/2"	4,5
05059320001	0,8	4,0	50	2"	4,0
05059478001	0,8	4,0	70	2 3/4"	4,0
05059480001	0,8	4,0	89	3 1/2"	4,0
05059451001	0,8	4,0	152	6"	4,0
05059325001	0,8	5,5	50	2"	5,5
05059330001	1,0	5,5	50	2"	5,5
05059486001	1,0	5,5	70	2 3/4"	5,5
05059488001	1,0	5,5	89	3 1/2"	5,5
05059452001	1,0	5,5	152	6"	5,5
05059335001	1,0	6,0	50	2"	6,0
05059337001	1,2	6,5	50	2"	6,2
05059492001	1,2	6,5	70	2 3/4"	6,2
05059490001	1,2	6,5	89	3 1/2"	6,2
05059453001	1,2	6,5	152	6"	6,2
05059340001	1,2	8,0	50	2"	8,0
05059496001	1,2	8,0	89	3 1/2"	8,0
05059345001	1,6	8,0	50	2"	8,0
05059500001	1,6	8,0	89	3 1/2"	8,0



5/16" hexagon drive, suitable for D 8 bit holders or direct drive (series 2)

800/2 Z bits



Application: Slotted screws

Drive: 5/16" hexagon, suitable for DIN ISO 1173-D 8 bit holders

Design: Tough, for universal use

	mm	mm	mm		mm
05057210001	0,8	5,5	41	1 19/32"	5,5
05057213001	1,0	5,5	41	1 19/32"	5,5
05057223001	1,2	6,5	41	1 19/32"	6,5
05057225001	1,2	8,0	41	1 19/32"	7,8
05057230001	1,6	8,0	41	1 19/32"	7,8
05057235001	1,6	10,0	41	1 19/32"	7,8
05057240001	2,0	12,0	41	1 19/32"	12,0
05057250001	2,5	14,0	41	1 19/32"	14,0
05057255001	2,5	16,0	41	1 19/32"	16,0



4 mm 4 mm Halfmoon direct drive (series 9)

800/9 C bits

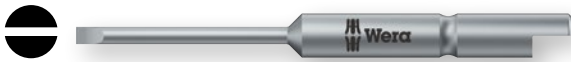

Application: Slotted screws

Drive: Halfmoon, 4 mm

Design: Hard

	mm	mm	mm		mm
05135265001	0,23	1,5	44	1 47/64"	1,5
05135264001	0,35	2,5	44	1 47/64"	2,5
05135266001	0,40	2,0	44	1 47/64"	2,0
05135267001	0,50	3,0	44	1 47/64"	3,0

Guide Sleeves

807/4 Z bits



Application: Slotted screws with integrated guide sleeve

Drive: 1/4" hexagon, suitable for DIN ISO 1173-F 6,3 bit holders

Design: Tough, for universal use

	mm	mm	mm		mm
05059503001	0,8	4,0	90	3 1/2"	10
05059507001	1,0	5,5	90	3 1/2"	11
05059515001	1,2	8,0	90	3 1/2"	13
05059517001	1,6	8,0	90	3 1/2"	13



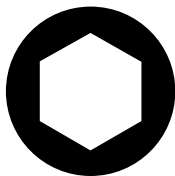

Bits for Hexagon Socket Screws



1/4" hexagon drive, suitable for D 6,3 bit holders (series 1)

840/1 IMP DC Impaktor bits



Application: Hexagon socket screws

Drive: 1/4" hexagon, suitable for DIN ISO 1173-D 6,3 bit holders

Design: The Impaktor technology ensures an above-average service life even under extreme conditions thanks to a best-possible utilisation of the material properties and optimally designed geometry, particularly suitable for use with conventional impact drivers, the rough diamond coating reduces the danger of any slipping out of the screw head due to the enhanced frictional resistance. Take it easy toolfinder: Output colour coding (blue = hexagon) and large stamp to enable the desired bit to be easily located.

	⊙ mm	┆ mm	┆ "
05057603001	3,0	25	1"
05057604001	4,0	25	1"
05057605001	5,0	25	1"
05057606001	6,0	25	1"

840/1 IMP DC Impaktor bits SB

	⊙	┆	┆
05073904001	1 x 4.0x25	158338	4013288
05073905001	1 x 5.0x25	158345	
05073906001	1 x 6.0x25	158352	



3840/1 TS bits, stainless

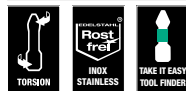

Application: Hexagon socket screws

Drive: 1/4" hexagon, suitable for DIN ISO 1173-D 6,3 bit holders

Design: Hex-Plus, stainless steel for minimising rust, special torsion-style design to reduce premature wear. Take it easy toolfinder: Output colour coding (blue = hexagon) and large stamp to enable the desired bit to be easily located.

	⊙ mm	⊙ "	┆ mm	┆ "
05071070001	1,5		25	1"
05071071001	2,0		25	1"
05071072001	2,5		25	1"
05071073001	3,0		25	1"
05071074001	4,0		25	1"
05071075001	5,0		25	1"
05071077001	5,5		25	1"
05071076001	6,0		25	1"
05071060001		3/32"	25	1"
05071061001		7/64"	25	1"
05071062001		1/8"	25	1"
05071063001		9/64"	25	1"
05071064001		5/32"	25	1"
05071065001		3/16"	25	1"
05071066001		1/4"	25	1"

840/1 BTZ bits



Application: Hexagon socket screws

Drive: 1/4" hexagon, suitable for DIN ISO 1173-D 6,3 bit holders

Design: Hex-Plus, BiTorsion for long service life, extra-tough, for universal use. Take it easy toolfinder: Output colour coding (blue = hexagon) and large stamp to enable the desired bit to be easily located.

	⊙ mm	┆ mm	┆ "
05056680001	1,5	25	1"
05056681001	2,0	25	1"
05056682001	2,5	25	1"
05056683001	3,0	25	1"
05056684001	4,0	25	1"
05056685001	5,0	25	1"
05056686001	5,5	25	1"
05056687001	6,0	25	1"





840/1 Z bits





Application: Hexagon socket screws

Drive: 1/4" hexagon, suitable for DIN ISO 1173-D 6,3 bit holders

Design: Hex-Plus, tough, for universal use

	 mm	 mm	 mm	 mm
05056303001	1,5	25	1"	
05056305001	2,0	25	1"	
05056310001	2,5	25	1"	
05056315001	3,0	25	1"	
05056320001	4,0	25	1"	
05056325001	5,0	25	1"	
05056330001	6,0	25	1"	
05056332001	7,0	25	1"	
05056335001	8,0	25	1"	
05056340001	10,0	25	1"	
05135060001	0,05"	25	1"	
05135070001	1/16"	25	1"	
05135071001	5/64"	25	1"	
05135072001	3/32"	25	1"	
05135078001	7/64"	25	1"	
05135073001	1/8"	25	1"	
05135069001	9/64"	25	1"	
05135074001	5/32"	25	1"	
05135075001	3/16"	25	1"	
05135079001	7/32"	25	1"	
05135076001	1/4"	25	1"	
05135077001	5/16"	25	1"	
05135068001	3/8"	25	1"	

840/1 Z Set SB

			 4013288
05073342001	○	1 x 2.0x25; 1 x 2.5x25; 1 x 3.0x25	029607
05073344001	○	1 x 4.0x25; 1 x 5.0x25; 1 x 6.0x25	029614





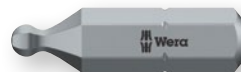

842/1 Z bits



Application: Hexagon socket screws

Drive: 1/4" hexagon, suitable for DIN ISO 1173-D 6,3 bit holders

Design: Ball end, tough, for universal use

	 mm	 mm	 mm	 mm
05056350001	2,5	25	1"	
05056352001	3,0	25	1"	
05056354001	4,0	25	1"	
05056356001	5,0	25	1"	
05056358001	6,0	25	1"	
05380103001		3/32"	25	1"
05380104001		7/64"	25	1"
05380105001		1/8"	25	1"
05380106001		9/64"	25	1"
05380107001		5/32"	25	1"
05380108001		3/16"	25	1"
05380109001		7/32"	25	1"
05380110001		1/4"	25	1"



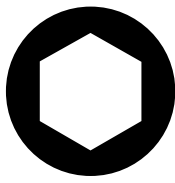

Bits for Hexagon Socket Screws



1/4" hexagon drive, suitable for F 6,3 bit holders (series 4)

840/4 IMP DC Impaktor bits



Application: Hexagon socket screws

Drive: 1/4" hexagon, suitable for DIN ISO 1173-F 6,3 bit holders

Design: The Impaktor technology ensures an above-average service life even under extreme conditions thanks to a best-possible utilisation of the material properties and optimally designed geometry, particularly suitable for use with conventional impact drivers, the rough diamond coating reduces the danger of any slipping out of the screw head due to the enhanced frictional resistance. Take it easy toolfinder: Output colour coding (blue = hexagon) and large stamp to enable the desired bit to be easily located.

	mm	mm	"
05057644001	4,0	50	2"
05057645001	5,0	50	2"
05057646001	6,0	50	2"

3840/4 Bits, stainless

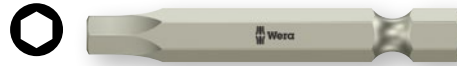

Application: Hexagon socket screws

Drive: 1/4" hexagon, suitable for DIN ISO 1173-F 6,3 bit holders

Design: Stainless steel for minimising rust

	mm	mm	"
05071101001	3,0	89	3 1/2"
05071102001	4,0	89	3 1/2"
05071103001	5,0	89	3 1/2"
05071049001	5,5	50	2"
05071104001	6,0	89	3 1/2"
05071105001		3/32"	89 3 1/2"
05071106001		1/8"	89 3 1/2"
05071107001		5/32"	89 3 1/2"
05071108001		3/16"	89 3 1/2"

840/4 IMP DC Impaktor bits SB

		4013288
05073944001	1 x 4.0x50	158451
05073945001	1 x 5.0x50	158468
05073946001	1 x 6.0x50	158475



840/4 Z bits



Application: Hexagon socket screws

Drive: 1/4" hexagon, suitable for DIN ISO 1173-F 6,3 bit holders

Design: Hex-Plus, tough, for universal use

	⊙ mm	⊙ mm	⊏ mm	⊏ mm	∅ mm
05160885001	0,9		50	2"	2,6
05059602001	1,5		50	2"	2,0
05059603001	2,0		50	2"	4,0
05059628001	2,0		89	3 1/2"	4,0
05059604001	2,5		50	2"	4,0
05059629001	2,5		89	3 1/2"	4,0
05059605001	3,0		50	2"	4,0
05059630001	3,0		89	3 1/2"	4,0
05380033001	3,0		152	6"	4,0
05059610001	4,0		50	2"	5,0
05059631001	4,0		89	3 1/2"	5,0
05059634001	4,0		152	6"	5,0
05059615001	5,0		50	2"	6,0
05059632001	5,0		89	3 1/2"	6,0
05059635001	5,0		152	6"	6,0
05059620001	6,0		50	2"	5,0
05059633001	6,0		89	3 1/2"	-
05059636001	6,0		152	6"	-
05059625001	8,0		50	2"	-
05350430001		0,05"	50	2"	2,5
05135090001		1/16"	50	2"	2,5
05380045001		1/8"	152	6"	4,0
05135091001		5/64"	50	2"	3,0
05059660001		5/64"	89	3 1/2"	3,0
05135092001		3/32"	50	2"	3,0
05059661001		3/32"	89	3 1/2"	3,5
05135093001		7/64"	50	2"	3,5
05059662001		7/64"	89	3 1/2"	4,0
05135094001		1/8"	50	2"	4,0
05059663001		1/8"	89	3 1/2"	4,0
05135095001		9/64"	50	2"	4,5
05059664001		9/64"	89	3 1/2"	4,5
05380046001		9/64"	152	6"	4,5
05135096001		5/32"	50	2"	5,0
05059665001		5/32"	89	3 1/2"	5,0
05380047001		5/32"	152	6"	5,0
05135097001		3/16"	50	2"	6,0
05059666001		3/16"	89	3 1/2"	6,0
05380048001		3/16"	152	6"	6,0
05135098001		7/32"	50	2"	-
05059667001		7/32"	89	3 1/2"	-
05380049001		7/32"	152	6"	-
05135099001		1/4"	50	2"	-
05059668001		1/4"	89	3 1/2"	-
05380050001		1/4"	152	6"	-
05346288001		5/16"	50	2"	-

Tip



Impaktor-Bits



Impact-Bits are needed when a strong power tool (e.g. 18 volt impact screwdriver) is used. Impact bits were specifically developed to withstand high power tool forces.



Hex-Plus

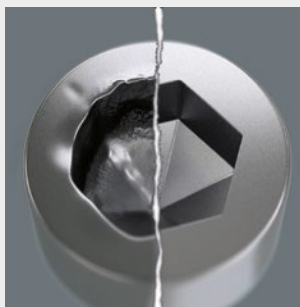

Hexagon screws can endure a problem because the contact surfaces delivering the power from the conventional tool, is transferred to the screw via very small surface areas. The consequence: the screw can become damaged (rounding out). Hex-Plus tools have a greater contact surface that prevents this from happening! Good to know: Hex-Plus tools fit into every standard hexagon socket screw!



"Take it easy"

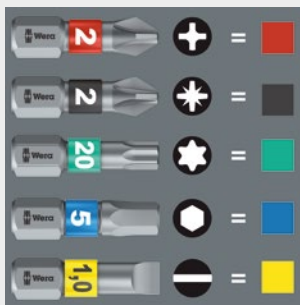

"Take it easy" tool finder with colour coding according to profiles and size stamp – for simple and rapid accessing of the required tool.



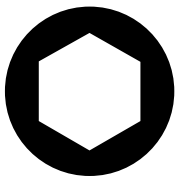

Bits for Hexagon Socket Screws



1/4" hexagon drive, suitable for F 6,3 bit holders (series 4)





842/4 Bits



Application: Hexagon socket screws

Drive: 1/4" hexagon, suitable for DIN ISO 1173-F 6,3 bit holders

Design: Ball end, tough, for universal use

	 mm	 mm	 mm	 mm
05059680001	3,0		89	3 1/2"
05059681001	4,0		89	3 1/2"
05059682001	5,0		89	3 1/2"
05059683001	6,0		89	3 1/2"
05380124001		3/32"	89	3 1/2"
05380125001		7/64"	89	3 1/2"
05380126001		1/8"	89	3 1/2"
05380127001		9/64"	89	3 1/2"
05380128001		5/32"	89	3 1/2"
05380129001		3/16"	89	3 1/2"
05380130001		7/32"	89	3 1/2"
05380131001		1/4"	89	3 1/2"



5/16" hexagon drive, suitable for D 8 bit holders or direct drive (series 2)

840/2 Z Bits



Application: Hexagon socket screws

Drive: 5/16" hexagon, suitable for DIN ISO 1173-D 8 bit holders

Design: Hex-Plus, tough, for universal use

	mm	mm	mm	"
05057505001	3	30	1 3/16	"
05057510001	4	30	1 3/16	"
05057550001	4	50	2	"
05057560001	4	70	2	"
05057570001	4	100	4	"
05057515001	5	30	1 3/16	"
05057551001	5	50	2	"
05057561001	5	70	2 3/4	"
05057571001	5	100	4	"
05057520001	6	30	1 3/16	"
05057552001	6	50	2	"
05057562001	6	70	2 3/4	"
05057572001	6	100	4	"
05057553001	7	50	2	"
05057573001	7	100	4	"
05057525001	8	30	1 3/16	"
05057554001	8	50	2	"
05057563001	8	70	2 3/4	"
05057574001	8	100	4	"
05057530001	10	30	1 3/16	"
05057555001	10	50	2	"
05057575001	10	100	4	"
05221102001	5/32	30	1 3/16	"
05057565001	5/32	70	2 3/4	"
05135083001	3/16	30	1 3/16	"
05135084001	7/32	30	1 3/16	"
05057566001	7/32	70	2 3/4	"
05135080001	1/4	30	1 3/16	"
05057567001	1/4	70	2 3/4	"
05135081001	5/16	30	1 3/16	"
05057568001	5/16	70	2 3/4	"
05135082001	3/8	30	1 3/16	"

Tip



Hexagon ball tip



The spherical drive profile means that it is possible to swivel the axis of the tool to that of the screw, and therefore enable angled, "around-the-corner" screw-driving jobs.



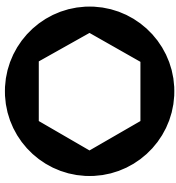

Bits for Hexagon Socket Screws



4 mm 4 mm Halfmoon direct drive (series 9)

840/9 C bits Hex-Plus



Application: Hexagon socket screws

Drive: Halfmoon, 4 mm

Design: Hard

	mm	mm	mm	mm
05135268001	1,5	44	1 ⁴⁷ / ₆₄ "	2,6
05135269001	2,0	44	1 ⁴⁷ / ₆₄ "	2,6

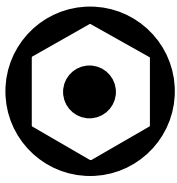

Bits for Tamper-Proof Hexagon Socket Screws with safety pin



1/4" hexagon drive, suitable for D 6,3 bit holders (series 1)

840/1 Z Tamper-proof Hex-Plus B0 bits



Application: Hexagon socket screws with safety pin (B0 = with bore hole)

Drive: 1/4" hexagon, suitable for DIN ISO 1173-D 6,3 bit holders

Design: Hex-Plus with bore hole, tough, for universal use

	mm	mm	"
05056341001	2,0	25	1"
05056342001	2,5	25	1"
05056343001	3,0	25	1"
05056344001	4,0	25	1"
05056345001	5,0	25	1"
05056346001	6,0	25	1"



1/4" hexagon drive, suitable for F 6,3 bit holders (series 4)

840/4 Z Tamper-proof Hex-Plus B0 bits



Application: Hexagon socket screws with safety pin (B0 = with bore hole)

Drive: 1/4" hexagon, suitable for DIN ISO 1173-F 6,3 bit holders

Design: Hex-Plus with bore hole, tough, for universal use

	mm	mm	"	mm
05059640001	2,0	89	3 1/2"	4,0
05059641001	2,5	89	3 1/2"	4,0
05059642001	3,0	89	3 1/2"	4,0
05059643001	4,0	89	3 1/2"	5,0
05059644001	5,0	89	3 1/2"	6,0
05059645001	6,0	89	3 1/2"	-



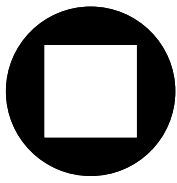

Bits for Square Socket Screws

1/4" hexagon drive, suitable for D 6,3 bit holders (series 1)

868/1 IMP DC Impaktor Square-Plus bits



Application: Square socket head screws

Drive: 1/4" hexagon, suitable for DIN ISO 1173-D 6,3 bit holders

Design: The Impaktor technology ensures an above-average service life even under extreme conditions thanks to a best-possible utilisation of the material properties and optimally designed geometry, particularly suitable for use with conventional impact drivers, the rough diamond coating reduces the danger of any slipping out of the screw head due to the enhanced frictional resistance

		mm	
05057631001	# 2	25	1"
05057632001	# 3	25	1"

868/1 IMP DC SB Impaktor Square-Plus bits

05073931001		1 x # 2x25	158437
05073932001		1 x # 3x25	158444



3868/1 TS Square-Plus bits, stainless



Application: Square socket head screws

Drive: 1/4" hexagon, suitable for DIN ISO 1173-D 6,3 bit holders

Design: Stainless steel for minimising rust, special torsion-style design to reduce premature wear

		mm	
05071025001	# 2	25	1"

868/1 BTZ Square-Plus bits



Application: Square socket head screws

Drive: 1/4" hexagon, suitable for DIN ISO 1173-D 6,3 bit holders

Design: BiTorsion for long service life, extra-tough, for universal use

		mm		mm
05066445001	# 1	25	1"	4,2
05066446001	# 2	25	1"	4,2
05066447001	# 3	25	1"	5,5





868/1 Z Square-Plus bits



Application: Square socket head screws

Drive: 1/4" hexagon, suitable for DIN ISO 1173-D 6,3 bit holders

Design: Tough, for universal use

		 mm	 "	 mm
05066395001	# 00	25	1"	3,5
05066400001	# 0	25	1"	3,5
05066405001	# 1	25	1"	4,5
05066410001	# 2	25	1"	6,0
05066415001	# 3	25	1"	6,0
05066420001	# 4	25	1"	8,0



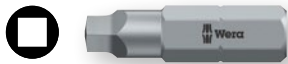

868/1 V Square-Plus bits





Application: Square socket head screws

Drive: 1/4" hexagon, suitable for DIN ISO 1173-D 6,3 bit holders

Design: Tough, for universal use, with holding function

		 mm	 "	 mm
05340245001	# 1	25	1"	6,1
05066394001	# 2	25	1"	6,1
05066396001	# 3	25	1"	6,1

Bit-Box 20 V Robertson

	 4013288 188083
05057790001	 868/1 V 20 x # 2x25



Tip



Impaktor-Bits



For an above-average service life. Maximum utilisation of the material properties, a very special geometry – designed particularly to meet the extreme demands – as well as a specific manufacturing process mean that Wera Impaktor tools have an above-average service life. Another product advantage is the coating of the Impaktor bits with minute diamond particles. These diamond particles reduce the cam-out effects – particularly high in power tool applications – which can lead to a slipping out of the screw head. The diamond particles literally bite themselves into the screw recess. This means that less contact pressure is required, something that greatly delays fatigue setting-in in power tool screwdriving jobs.

V bits:

Holding function for Robertson screws

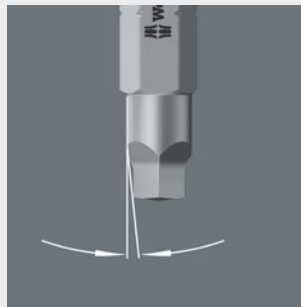

V bits have a conical profile. The clamping forces thus resulting hold Robertson screws securely on the tip of the tool. Ideal for screwdriving at difficult-to-access places.

Bit-Box

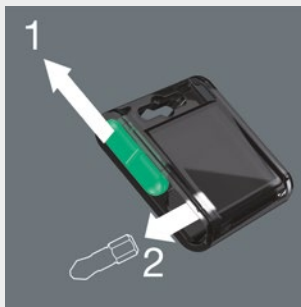

The slide switch allows a simple and gradual removal and reinsertion of the bits. The transparent reverse side means that it is easy to know how many bits are still in the box.



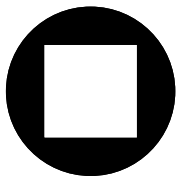

Bits for Square Socket Screws



1/4" hexagon drive, suitable for F 6,3 bit holders (series 4)

868/4 IMP DC Impaktor Square-Plus bits



Application: Square socket head screws

Drive: 1/4" hexagon, suitable for DIN ISO 1173-F 6,3 bit holders

Design: The Impaktor technology ensures an above-average service life even under extreme conditions thanks to a best-possible utilisation of the material properties and optimally designed geometry, particularly suitable for use with conventional impact drivers, the rough diamond coating reduces the danger of any slipping out of the screw head due to the enhanced frictional resistance

		 mm	 "
05057671001	# 2	50	2"
05057672001	# 3	50	2"

868/4 IMP DC SB Impaktor Square-Plus bits

05073971001		1 x # 2x50	158550
05073972001		1 x # 3x50	158567

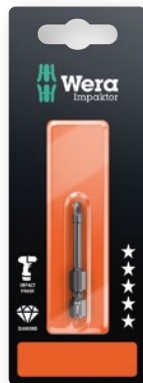

3868/4 Square-Plus bits, stainless



Application: Square socket screws

Drive: 1/4" hexagon, suitable for DIN ISO 1173-F 6,3 bit holders

Design: Stainless steel for minimising rust

		 mm	 "	 mm
05071097001	# 1	89	3 1/2"	4,5
05071098001	# 2	89	3 1/2"	5,0
05071099001	# 3	89	3 1/2"	5,5

868/4 BTZ Square-Plus bits



Application: Square socket head screws

Drive: 1/4" hexagon, suitable for DIN ISO 1173-F 6,3 bit holders

Design: BiTorsion for long service life, extra-tough, for universal use

		 mm	 "	 mm
05060147001	#1	50	2"	4,2
05060148001	#2	50	2"	4,2
05060149001	#3	50	2"	5,5





868/4 Square-Plus bits



Application: Square socket head screws

Drive: 1/4" hexagon, suitable for DIN ISO 1173-F 6,3 bit holders

Design: Tough, for universal use

		 mm	 "	 mm
05060150001	# 00	50	2"	3,5
05060155001	# 0	50	2"	3,5
05060160001	# 1	50	2"	4,5
05060180001	# 1	70	2 3/4"	4,5
05134800001	# 1	89	3 1/2"	4,5
05134805001	# 1	152	6"	4,5
05060165001	# 2	50	2"	6,0
05060182001	# 2	70	2 3/4"	6,0
05134801001	# 2	89	3 1/2"	6,0
05134806001	# 2	152	6"	6,0
05060170001	# 3	50	2"	6,0
05060184001	# 3	70	2 3/4"	6,0
05134802001	# 3	89	3 1/2"	6,0
05134807001	# 3	152	6"	6,0
05060175001	# 4	50	2"	8,0





868/4 V Square-Plus bits



Application: Square socket head screws

Drive: 1/4" hexagon, suitable for DIN ISO 1173-F 6,3 bit holders

Design: Tough, for universal use, with holding function

		 mm	 "	 mm
05060300001	# 1	50	2"	4,5
05060297001	# 1	89	3 1/2"	4,5
05060301001	# 2	50	2"	6,0
05060302001	# 2	70	2 3/4"	6,0
05060303001	# 2	89	3 1/2"	6,0
05060304001	# 2	152	6"	6,0
05060296001	# 3	50	2"	6,0
05060298001	# 3	89	3 1/2"	6,0

Tip



BTZ-Bits

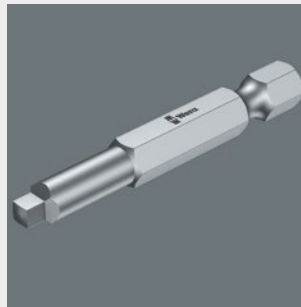

BTZ-Bits have an additional tempered BitTorsion zone, which reduces the hardness of the shaft by about 20 % in comparison to the drive tip. This means that the peak loads that cause bit breakage and premature wear are absorbed in this zone – something which enhances the service life of the bits.



Stainless Steel Bits



Wera stainless steel bits are manufactured out of stainless steel so unsightly rust can be avoided. The stainless steel bits from Wera are vacuum ice-hardened and have the hardness and strength needed for screw connections. There are no limitations to the industrial applications they are suitable for.

V bits:

Holding function for Robertson screws

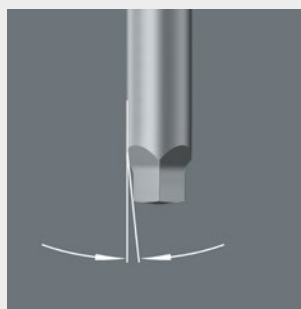

V bits have a conical profile. The clamping forces thus resulting hold Robertson screws securely on the tip of the tool. Ideal for screwdriving at difficult-to-access places.



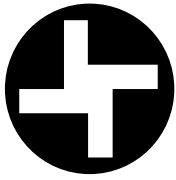

Bits for TORQ-SET® Screws



1/4" hexagon drive, suitable for D 6,3 bit holders (series 1)





871/1 DC TORQ-SET® Mplus bits



Application: TORQ-SET® screws

Drive: 1/4" hexagon, suitable for DIN ISO 1173-D 6,3 bit holders

Design: Mplus for higher breaking torque and longer service life, diamond-coated for secure screw fit

	 mm	 mm	 mm	 mm	 mm
05066638001	4	25	1"	4,7	
05066640001	6	25	1"	4,7	
05066642001	8	25	1"	6,0	
05066644001	10	25	1"	6,0	
05066646001	1/4"	32	1 1/4"	11,0	





871/1 TORQ-SET® Mplus bits, 32 mm



Application: TORQ-SET® screws

Drive: 1/4" hexagon, suitable for DIN ISO 1173-D 6,3 bit holders

Design: Mplus for higher breaking torque and longer service life, tough, for universal use

	 mm	 mm	 mm	 mm
05066634001	1/4"	32	1 1/4"	11,0
05066635001	5/16"	32	1 1/4"	11,0

871/1 TORQ-SET® Mplus bits, 25 mm



Application: TORQ-SET® screws

Drive: 1/4" hexagon, suitable for DIN ISO 1173-D 6,3 bit holders

Design: Mplus for higher breaking torque and longer service life, tough, for universal use

	 mm	 mm	 mm	 mm	 mm
05066618001	0	25	1"	4,7	
05066619001	1	25	1"	4,7	
05066620001	2	25	1"	4,7	
05066622001	3	25	1"	4,7	
05066624001	4	25	1"	4,7	
05066626001	5	25	1"	4,7	
05066628001	6	25	1"	4,7	
05066630001	8	25	1"	6,0	
05066632001	10	25	1"	6,0	
05066633001	1/4"	25	1"	6,0	



1/4" hexagon drive, suitable for F 6,3 bit holders (series 4)





871/4 DC TORQ-SET® Mplus bits



Application: TORQ-SET® screws

Drive: 1/4" hexagon, suitable for DIN ISO 1173-F 6,3 bit holders

Design: Mplus for higher breaking torque and longer service life, diamond-coated for secure screw fit

	 mm	 mm	 mm	 mm
05324901001	2	50	2"	
05066688001	4	50	2"	
05066690001	6	50	2"	
05066692001	8	50	2"	
05066694001	10	50	2"	
05066696001		1/4"	50	2"
05344515001		5/16"	50	2"





871/4 TORQ-SET® Mplus bits



Application: TORQ-SET® screws

Drive: 1/4" hexagon, suitable for DIN ISO 1173-F 6,3 bit holders

Design: Mplus for higher breaking torque and longer service life

	 mm	 mm	 mm	 mm
05066660001	2	50	2"	
05066683001	2	89	3 1/2"	
05066662001	3	50	2"	
05066684001	3	89	3 1/2"	
05066664001	4	50	2"	
05066685001	4	89	3 1/2"	
05066666001	5	50	2"	
05066668001	6	50	2"	
05066676001	6	70	2 3/4"	
05066686001	6	89	3 1/2"	
05066670001	8	50	2"	
05066678001	8	70	2 3/4"	
05066687001	8	89	3 1/2"	
05066672001	10	50	2"	
05066680001	10	70	2 3/4"	
05066682001	10	89	3 1/2"	
05066674001		1/4"	50	2"
05221110001		5/16"	50	2"

Tip

TORQ-SET® Mplus

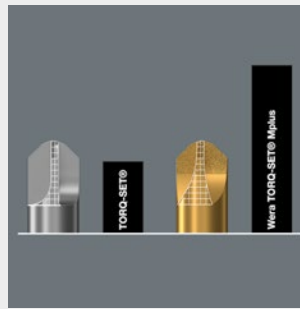

Wera developed the Mplus profile with stronger flanks compared with tools with a conventional TORQ-SET® profile. This results in approximately 70% extra torsional strength and greatly extends the service life of Wera Mplus tools.



Bits with diamond coating



The diamond coating of the DC bits lowers the danger of slipping as the minute diamond particles literally "bite" themselves into the screw head.





Bits for TORQ-SET® Screws



5/16" hexagon drive, suitable for D 8 bit holders or direct drive (series 2)





871/2 TORQ-SET® Mplus bits



Application: TORQ-SET® screws

Drive: 5/16" hexagon, suitable for DIN ISO 1173-D 8 bit holders

Design: Mplus for higher breaking torque and longer service life, tough, for universal use

	 mm	 mm	 mm	 mm
05066650001	8		32	1 1/4"
05066652001	10		32	1 1/4"
05066654001		1/4"	32	1 1/4"
05066656001		5/16"	32	1 1/4"
05066658001		3/8"	32	1 1/4"



7/16" hexagon drive, suitable for F 11,2 bit holders or direct drive (series 7)





871/7 TORQ-SET® Mplus bits



Application: TORQ-SET® screws

Drive: 7/16" hexagon, suitable for power tools with DIN ISO 1173-F 11,2 chuck

Design: Mplus for higher breaking torque and longer service life

	 mm	 mm	 mm	 mm
05066740001	1/4"	35	1 3/8"	11,0
05066742001	5/16"	35	1 3/8"	11,0
05066744001	3/8"	35	1 3/8"	11,0
05066746001	7/16"	35	1 3/8"	11,0



5/16" hexagon drive, suitable for F 8 bit holders or direct drive (series 6)





871/6 TORQ-SET® Mplus bits



Application: TORQ-SET® screws

Drive: 5/16" hexagon, suitable for DIN ISO 1173-F 8 bit holders

Design: Mplus for higher breaking torque and longer service life

	 mm	 mm	 mm	 mm	 mm
05066700001	8		35	1 3/8"	6,0
05066702001	10		35	1 3/8"	6,0
05066704001		1/4"	35	1 3/8"	11,0



5/8" direct drive hexagon (series 19)



871/19 TORQ-SET® Mplus bits



Application: TORQ-SET® screws

Drive: 5/8" hexagon

Design: Mplus for higher breaking torque and longer service life

	 mm	 mm	 mm
05066750001	1/2"	40	1 9/16"
05066752001	9/16"	40	1 9/16"
05066754001	5/8"	40	1 9/16"

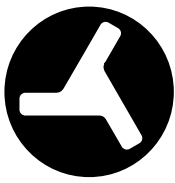

Bits for TRI-WING® Screws



1/4" hexagon drive, suitable for D 6,3 bit holders (series 1)

875/1 TRI-WING® bits, 25 mm



Application: TRI-WING® screws

Drive: 1/4" hexagon, suitable for DIN ISO 1173-D 6,3 bit holders

Design: Tough, for universal use

		□, mm	□, "	∅ mm
05066758001	0	25	1"	4,7
05066760001	1	25	1"	4,7
05066762001	2	25	1"	4,7
05066764001	3	25	1"	4,7
05066766001	4	25	1"	6,2
05066768001	5	25	1"	6,2

875/1 TRI-WING® bits, 32 mm



Application: TRI-WING® screws

Drive: 1/4" hexagon, suitable for DIN ISO 1173-D 6,3 bit holders

Design: Tough, for universal use

		□, mm	□, "	∅ mm
05066770001	6	32	1 1/4"	11,0
05066772001	7	32	1 1/4"	11,0
05066774001	8	32	1 1/4"	12,5



1/4" hexagon drive, suitable for F 6,3 bit holders (series 4)

875/4 TRI-WING® bits



Application: TRI-WING® screws

Drive: 1/4" hexagon, suitable for DIN ISO 1173-F 6,3 bit holders

Design: Tough, for universal use

		□, mm	□, "
05066785001	1	89	3 1/2"
05066786001	2	89	3 1/2"
05066787001	3	89	3 1/2"
05066780001	4	50	2"
05066788001	4	89	3 1/2"
05066782001	5	50	2"
05066784001	6	50	2"



5/16" hexagon drive, suitable for F 8 bit holders or direct drive (series 6)

875/6 TRI-WING® bits



Application: TRI-WING® screws

Drive: 5/16" hexagon, suitable for DIN ISO 1173-F 8 bit holders

Design: Tough, for universal use

		□, mm	□, "	∅ mm
05066790001	6	35	1 3/8"	11,0
05066792001	7	35	1 3/8"	11,0
05066794001	8	35	1 3/8"	12,5



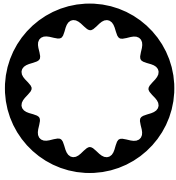

Bits for Multi-Point Screws



1/4" hexagon drive, suitable for D 6,3 bit holders (series 1)

860/1 XZN Multi-point bits



Application: Multi-point socket screws

Drive: 1/4" hexagon, suitable for DIN ISO 1173-D 6,3 bit holders

Design: Tough, for universal use

		mm	"	mm
05066150001	M 4	25	1"	4,17
05066155001	M 5	25	1"	5,14
05066160001	M 6	25	1"	-
05066165001	M 8	25	1"	8,0
05066170001	M 10	25	1"	10,0



1/4" hexagon drive, suitable for F 6,3 bit holders (series 4)

860/4 XZN Multi-point bits



Application: Multi-point socket screws

Drive: 1/4" hexagon, suitable for DIN ISO 1173-F 6,3 bit holders

Design: Tough, for universal use

		mm	"	mm
05066175001	M 4	50	2"	4,17
05066180001	M 5	50	2"	5,14
05066185001	M 6	50	2"	-
05066190001	M 8	50	2"	8,0
05066195001	M 10	50	2"	10,0
05066200001	M 12	50	2"	12,0

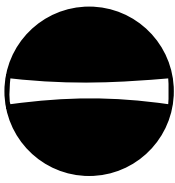

Bits for Hi-TORQUE Screws



1/4" hexagon drive, suitable for D 6,3 bit holders (series 1)

800/1 HTN Hi-TORQUE bits



Application: Hi-TORQUE screws

Drive: 1/4" hexagon, suitable for DIN ISO 1173-D 6,3 bit holders

		□, mm	□,
05055950001	1	32	1 1/4"
05055951001	2	32	1 1/4"
05055952001	3	32	1 1/4"
05055953001	4	32	1 1/4"

700 A HTS Hi-TORQUE bits



Application: For Hi-TORQUE screws

Drive: 1/4"-square drive socket

		□, mm	□,
05040030001	0	25	1"
05040031001	1	25	1"
05040032001	2	25	1"
05040033001	3	25	1"
05040034001	4	25	1"

700 B HTS Hi-TORQUE bits



Application: For Hi-TORQUE screws

Drive: 3/8"-square drive socket

		□, mm	□,
05040040001	3	25	1"
05040041001	4	25	1"
05040042001	5	32	1 1/4"
05040043001	6	32	1 1/4"

700 C HTS Hi-TORQUE bits



Application: For Hi-TORQUE screws

Drive: 1/2"-square drive socket

		□, mm	□,
05040045001	7	42	1 5/8"
05040046001	8	42	1 5/8"
05040047001	9	42	1 5/8"
05040048001	10	42	1 5/8"
05040049001	12	60	2 3/8"





Bits for Microstix® Screws



4 mm 4 mm Halfmoon direct drive (series 9)

872/9 bits for Microstix® screws



Application: Microstix® socket screws
Drive: Halfmoon, 4 mm
Design: Precision hardened for sensitive applications

		l, mm	∅ mm	l ⁺ "
05066850001	m	44	2,0	1 47/64 "
05066851001	00	44	2,0	1 47/64 "
05066852001	F	44	2,0	1 47/64 "
05066853001	0	44	2,0	1 47/64 "
05066854001	1	44	2,0	1 47/64 "



4 mm 4 mm HIOS direct drive (series 21)

872/21 bits for Microstix® screws



Application: Microstix® socket screws
Drive: HIOS 4 mm
Design: Precision hardened for sensitive applications

		l, mm	∅ mm	l ⁺ "
05066860001	m	40	2,0	1 9/16 "
05066861001	00	40	2,0	1 9/16 "
05066862001	F	40	2,0	1 9/16 "
05066863001	0	40	2,0	1 9/16 "
05066864001	1	40	2,0	1 9/16 "



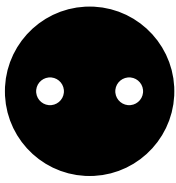

Bits for Spanner Screws



1/4" hexagon drive, suitable for D 6,3 bit holders (series 1)

857/1 Z Spanner bits



Application: Spanner screws

Drive: 1/4" hexagon, suitable for DIN ISO 1173-D 6,3 bit holders

Design: Tough, for universal use

		 mm	 mm	 mm
05057150001	4	25	1"	3,18
05057151001	6	25	1"	4,32
05057152001	8	25	1"	5,21
05057153001	10	25	1"	6,10



1/4" hexagon drive, suitable for F 6,3 bit holders (series 4)

857/4 Z Spanner bits



Application: Spanner screws

Drive: 1/4" hexagon, suitable for DIN ISO 1173-F 6,3 bit holders

Design: Tough, for universal use

		 mm	 mm	 mm
05057160001	4	89	3 1/2"	3,18
05057161001	6	89	3 1/2"	4,32
05057162001	8	89	3 1/2"	5,21
05057163001	10	89	3 1/2"	6,10

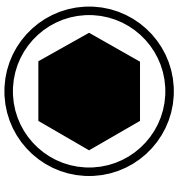

Nutsetters



1/4" hexagon drive, suitable for F 6,3 bit holders (series 4)

3869/4 Nutsetters, stainless



Application: Hexagon headed bolts, screws and nuts

Drive: 1/4" hexagon, suitable for DIN ISO 1173-F 6,3 bit holders

Design: Non-magnetic, retaining spring, stainless steel for minimising rust

	mm	mm	mm	mm
05071222001	7,0	7,0	50,0	12,5
05071223001	8,0	8,0	50,0	14,0
05071224001	10,0	10,0	50,0	16,0
05071225001	13,0	13,0	50,0	19,5
05071228001	16,0	3/8"	50,0	16,0

869/4 Nutsetters



Application: Hexagon headed bolts, screws and nuts

Drive: 1/4" hexagon, suitable for DIN ISO 1173-F 6,3 bit holders

Design: Non-magnetic

	mm	mm	mm	mm
05060400001	5,5	5,5	50,0	11,0
05060272001	5,5	5,5	65,0	9,5
05060401001	6,0	6,0	50,0	11,0
05060274001	6,0	6,0	65,0	11,0
05060402001	7,0	7,0	50,0	11,0
05060276001	7,0	7,0	65,0	11,0
05060403001	8,0	8,0	50,0	12,5
05060278001	8,0	8,0	65,0	12,5
05060404001	9,0	9,0	50,0	14,0
05060280001	9,0	9,0	65,0	14,0
05060405001	10,0	10,0	50,0	14,0
05060282001	10,0	10,0	65,0	14,0
05060406001	11,0	11,0	50,0	16,0
05060281001	11,0	11,0	65,0	16,0
05060407001	12,0	12,0	50,0	18,0
05060283001	12,0	12,0	65,0	17,0
05060408001	13,0	13,0	50,0	18,0
05060284001	13,0	13,0	65,0	19,0
05060409001		1/4"	50,0	11,0
05060286001		1/4"	65,0	11,0
05060410001		5/16"	50,0	12,5
05060290001		5/16"	65,0	12,5
05060411001		3/8"	50,0	14,0
05060288001		3/8"	65,0	14,0
05060412001		7/16"	50,0	16,0



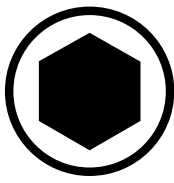

Nutsetters

1/4" hexagon drive, suitable for direct drive DIN ISO 1173-F 6,3 machine chucks (series 4)

869/4 M Nutsetters, magnetic



Application: Hexagon headed bolts, screws and nuts

Drive: 1/4" hexagon, suitable for DIN ISO 1173-F 6,3 bit holders

Design: Strong permanent magnet

	mm	mm	mm	mm
05060420001	5,5	50,0	11,0	
05060210001	5,5	65,0	11,0	
05060421001	6,0	50,0	11,0	
05060215001	6,0	65,0	11,0	
05060422001	7,0	50,0	11,0	
05060220001	7,0	65,0	11,0	
05060423001	8,0	50,0	12,5	
05060225001	8,0	65,0	12,5	
05060424001	9,0	50,0	14,0	
05060230001	9,0	65,0	14,0	
05060425001	10,0	50,0	14,0	
05060235001	10,0	65,0	14,0	
05060426001	11,0	50,0	16,0	
05060237001	11,0	65,0	16,0	
05060427001	12,0	50,0	18,0	
05060238001	12,0	65,0	17,0	
05060428001	13,0	50,0	18,0	
05060240001	13,0	65,0	19,0	
05060429001	1/4"	50,0	11,0	
05060255001	1/4"	65,0	11,0	
05060430001	5/16"	50,0	12,5	
05060260001	5/16"	65,0	12,5	
05060431001	3/8"	50,0	14,0	
05060265001	3/8"	65,0	14,0	
05060432001	7/16"	50,0	16,0	

869/4 M SB Nutsetters, magnetic

		4013288
05073500001	● 1 x 5.5x50.0	105691
05073501001	● 1 x 6.0x50.0	105707
05073502001	● 1 x 7.0x50.0	106506
05073503001	● 1 x 8.0x50.0	105714
05073504001	● 1 x 9.0x50.0	105721
05073505001	● 1 x 10.0x50.0	105738
05073506001	● 1 x 11.0x50.0	105745
05073507001	● 1 x 12.0x50.0	105752
05073508001	● 1 x 13.0x50.0	105769
05073509001	● 1 x 1/4"x50.0	105776
05073510001	● 1 x 3/8"x50.0	105783



869/4 M Set A SB



8 piece set, with strong permanent magnet, in practical pouch for the belt

		4013288
05073495001	869/4 M ● 1 x 7.0x50.0; 1 x 8.0x50.0; 1 x 10.0x50.0; 1 x 12.0x50.0; 1 x 13.0x50.0; 1 x 1/4"x50.0; 1 x 5/16"x50.0; 1 x 3/8"x50.0	144584

4 mm 4 mm Halfmoon direct drive (series 9)

869/9 Nutsetters



Application: Hexagon headed bolts, screws and nuts

Drive: Halfmoon, 4 mm

Design: Non-magnetic

	mm	mm	mm
05135224001	2,5	44,0	5,0
05135225001	3,0	44,0	5,0

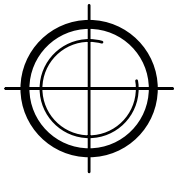

Internal Thread Insertion Tool



1/4" hexagon drive, suitable for F 6,3 bit holders (series 4)





879/4 Internal thread insertion tool



Application: Hanger bolts and threaded rods

Drive: 1/4" hexagon, suitable for DIN ISO 1173-F 6,3 bit holders









Design: Internal thread

		 mm	 2"	 mm
05135902001	M6	50,0	2"	8,0
05135903001	M8	50,0	2"	12,0
05135904001	M10	50,0	2"	12,0





Holders and Adaptors

	Impaktor Bit Holders	410
	Rapidaptor Bit Holders	414
	BiTorsion Bit Holders with Quick-Release Chuck	418
	Universal Bit Holders with Quick-Release Chuck	419
	Universal Bit Holders with Retaining Ring	421
	Universal Bit Holders with Stainless Steel Sleeve	422
	Universal Bit Holders with Copper Beryllium Sleeve	424
	Bit Holder with Adjustable Depth-Control Stop	425
	Adaptors	426



Bit Holders and Adaptors

We were not happy that bit change with bit holders was often quite cumbersome. We found out that strong magnets or retaining rings indeed hold the bit securely, but they greatly impede removal from the holder.

So we have developed bit holders that indeed reliably hold the bit, yet still allow for fast and trouble-free bit change. The solution: bit holders with quick-release mechanisms that lift the bit from the magnets. Bit holders which – depending on the requirements – additionally have elastic zones that absorb peak loads. Or rapid-spin sleeves with which the cordless or electric screwdrivers can be guided during the screwdriving process.

Impaktor holder

Suitable for extra high torque e.g. from modern 18 volt impact screwdrivers with particularly high resilience. Reduces the risk of premature breakage of the holder or bit and increases the productivity when screwdriving with power tools.



Rapidaptor stainless steel

Manufactured out of stainless steel thus preventing the formation of unsightly extraneous rust when working with stainless steel. Additionally, it offers all the advantages of the Rapidaptor technology.



BiTorsion holder

Designed with special BiTorsion zone. The energy from peak loads is diverted into the BiTorsion zone. Considerable reduction of the risk of breakage, much longer service life.



Rapidaptor holder

Rapid bit change without needing any additional tools. One-hand operation with a freely spinning sleeve for simplified guidance of the tool. Also available in a BiTorsion design.



Ring magnet Rapidaptor

Special design powerful ring magnet, for larger and heavier screws. Ideal for overhead work, too.



Holder with quick-release chuck

The magnetic design enables simplified positioning of the screw. The non-magnetic version prevents any unwanted attraction of metal filings.



Universal holder with retaining ring
Proven holder design, optimal fitting of the tool in the holder. Particularly robust for series applications.



Copper Beryllium universal holder with retaining ring
Very strong design thus minimising wear and tear. Particularly suitable for screw-driving jobs with high torque or peak loads. Very high resistance to corrosion.



Universal holder with stainless steel sleeve
The retaining ring and the strong permanent magnet ensure a particularly secure fitting of the bit in the holder.



Impaktor Bits and Holders

Impaktor holder technology ensures an above-average service life even under extreme conditions thanks to a best-possible utilisation of the material properties and optimally designed geometry (two coupled torsion zones that perform successively).



The Impaktor stainless steel holder with a retaining ring and magnet satisfies the extreme, dynamic requirements in that there are consciously no small mechanical component parts fitted as they would be more susceptible to failure. It focuses on the basic bit holding function and the cushioning of the extreme impulse peaks with its two different torsion zones. Mainly used in industrial screw assembly applications e.g. with screwdriving robots.

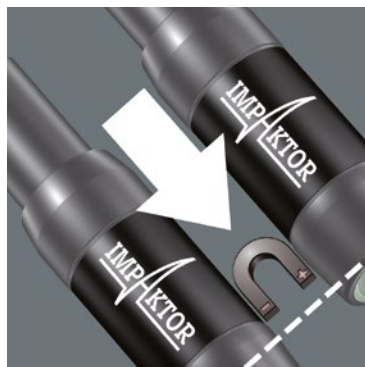

The Impaktor holder with ring magnet additionally holds longer and heavier screws absolutely securely. This enables a speedy and dependable positioning of the screw. It is also ideal for above-head work. Should the magnet function not be required in a particular situation e.g. when working with metal, it can be extracted from the screwdriving area and can thereby be “disabled”. Mainly used in manual power tool applications.



The combination of the double torsion zones in the Impaktor holder and the torsion zone in the Impaktor bit result in the so-called TriTorsion system.



Wera Impaktor bits and holders can also be used individually. However, the best results are achieved with the combination of the two tools that are optimally matched to one another.



Impaktor Bit Holders

For an above-average service life

897/4 IMP Impaktor holder with retaining ring and magnet



Impaktor holder to cushion extreme impulse peaks, special torsion effect from the double-torsion spring, equipped with a retaining ring for a secure fit of the bits in the holder, holder out of stainless steel, fitted with magnet for a secure positioning of the bit and screw.

Output: Suitable for bits with 1/4" hexagon head drive as per DIN ISO 1173-C 6,3 and Wera Series 1

Design: The Impaktor technology ensures an above-average service life even under extreme conditions thanks to a best-possible utilisation of the material properties and optimally designed geometry (two coupled torsion zones that perform successively), fitted with strong retaining ring and magnet

Drive: 1/4" hexagon, suitable for power driven screwdrivers with DIN ISO 1173-F 6,3 chucks

		mm		
05057675001	1/4"	75	3"	1/4"

897/4 IMP R Impaktor holder with retaining ring and ring magnet



Impaktor holder to cushion extreme impulse peaks, special torsion effect from the double-torsion spring, equipped with a ring magnet to easily hold longer and heavier screws, also ideal for above-head work, particularly suitable for use with impact drivers, the magnet can be retracted and in this way be disabled

Output: Suitable for bits with 1/4" hexagon head drive as per DIN ISO 1173-C 6,3 and Wera Series 1

Design: The Impaktor technology ensures an above-average service life even under extreme conditions thanks to a best-possible utilisation of the material properties and optimally designed geometry (two coupled torsion zones that perform successively), fitted with retaining ring and ring magnet

Drive: 1/4" hexagon, suitable for power driven screwdrivers with DIN ISO 1173-F 6,3 chucks

		mm		
05057676001	1/4"	75	3"	1/4"

897/4 IMP R SB Impaktor holder with retaining ring and ring magnet

05073990001	1 x 1/4"x75	4013288 157836

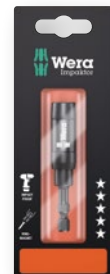



Rapidaptor Bit Holders

Wera developed the Rapidaptor that allows rapid bit change without any extra tools with only one hand.



Chuck-all

The Rapidaptor quick-release chucks hold both $\frac{1}{4}$ " bits as per DIN ISO 1173-C 6,3 (Wera series 1) and E 6,3 (Wera series 4).



Single-hand

All functions of the quick-release chuck such as the inserting or releasing of bits can be done with just one hand. That is faster, more economic and ergonomic. There are no unnecessary manoeuvres.

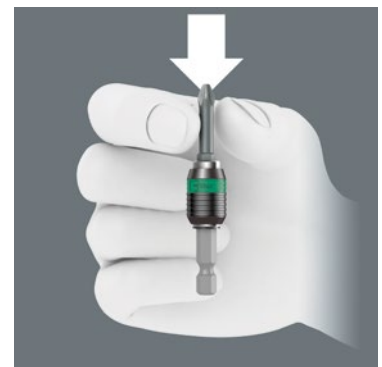

Rapid-in and self-lock

The bit can be pushed into the chuck without moving the sleeve. It automatically locks with a secure and wobble-free fit as soon as the bit is applied to the screw.



Rapid-out

Simply push the sleeve forward to change the bit. The spring mechanism lifts the bit off the magnet and unlocks the tool. The bit can be easily removed. Particularly helpful: even the smallest bits can be removed without any extra tools.



Rapid-spin

The free-turning sleeve allows screw steadying at the start of the screwdriving process. This makes it easier to apply the tool to the screw and prevents slipping. It can also be used as a short extension for 1/4" applications e.g. in combination with the Wera Zyklop Ratchets.



Rapidaptor with ring magnet

The floating, free-turning magnetic sleeve securely holds even large and heavy screws to enable immediate application. There is no need to hold the screw when applying the tool – something which can be dangerous and painful. Also ideal for overhead work.



Rapidaptor Bit Holders

For rapid bit changes

3888/4/1 K Rapidaptor Universal Bit Holder stainless



Application: Suitable for 1/4" DIN ISO 1173-C 6,3 and E 6,3 hexagon insert bits and Wera Series 1 and 4

Design: Rapidaptor rapid-in, rapid-out, rapid-spin, chuck-all and single-hand Technology; stainless steel for minimising rust

Drive: 1/4" hexagon, suitable for power tools with DIN ISO 1173-F 6,3 chuck

	mm	mm	mm	mm	mm
05071100001	1/4"	50	2"	1/4"	15,0

3888/4/1 K SB Rapidaptor Universal Bit Holder, stainless

		Barcode
05073616001	1 x 1/4"x50	4013288 112170



897/4 R Rapidaptor BiTorsion Universal Bit Holder



Application: Suitable for 1/4" DIN ISO 1173-C 6,3 and E 6,3 hexagon insert bits and Wera Series 1 and 4

Design: BiTorsion for long service life, Rapidaptor rapid-in, rapid-out, rapid-spin, chuck-all, and single-hand technology

Drive: 1/4" hexagon suitable for power tools with DIN ISO 1173-F 6,3 receiver

	mm	mm	mm	mm	mm
05053923001	1/4"	75	3"	1/4"	15,0

897/4 R SB Rapidaptor BiTorsion Universal Bit Holder

		Barcode
05073420001	1 x 1/4"x75	4013288 099464







889/4/1 K Rapidaptor Universal Bit Holder







Application: Suitable for 1/4" DIN ISO 1173-C 6,3 and E 6,3 hexagon insert bits and Wera Series 1 and 4

Design: Rapidaptor rapid-in, rapid-out, rapid-spin, chuck-all, and single-hand technology, with strong permanent magnet

Drive: 1/4" hexagon suitable for power tools with DIN ISO 1173-F 6,3 receiver

					
	mm	mm	mm	mm	mm
05052502001	1/4"	50	2"	1/4"	15,0

889/4/1 K SB Rapidaptor Universal Bit Holder

	
	4013288
05073421001	099440
 	1 x 1/4"x50



Tip



BiTorsion Rapidaptor



BiTorsion holders from Wera have a torsion spring design that absorbs smaller peak loads during screwdriving. The combined use with BiTorsion bits with their torsion zone distinctly extends the service life of the tool. Conveniently, BiTorsion holders from Wera can also be used with conventional bits.



Rapidaptor holder out of stainless steel



Manufactured out of stainless steel thus preventing the formation of unsightly extraneous rust when working with stainless steel. Additionally, it offers all the advantages of the Rapidaptor technology.



Rapidaptor Bit Holders

For rapid bit changes





889/4/1 Rapidaptor Universal Bit Holder



Application: Suitable for 1/4" DIN ISO 1173-C 6,3 and E 6,3 hexagon insert bits and Wera Series 1 and 4

Design: Rapidaptor easy-in, easy-out, rapid-spin, chuck-all, and single-hand technology, with strong permanent magnet

Drive: 1/4" hexagon suitable for power tools with DIN ISO 1173-F 6,3 receiver

					
	1/4"	mm	3"	1/4"	mm
05052503001	1/4"	75	3"	1/4"	15,0





888/4/1 K Rapidaptor Universal Bit Holder



Application: Suitable for 1/4" DIN ISO 1173-C 6,3 and E 6,3 hexagon insert bits and Wera Series 1 and 4

Design: Rapidaptor easy-in, easy-out, rapid-spin, chuck-all, and single-hand technology

Drive: 1/4" hexagon suitable for power tools with DIN ISO 1173-F 6,3 receiver

					
	1/4"	mm	2"	1/4"	mm
05052500001	1/4"	50	2"	1/4"	15,0





889/4 R Rapidaptor Universal Bit Holder



Application: Suitable for 1/4" DIN ISO 1173-C 6,3 and E 6,3 hexagon insert bits and Wera Series 1 and 4

Drive: 1/4" hexagon suitable for power tools with DIN ISO 1173-F 6,3 receiver

Design: 1/4" hexagon with Rapidaptor rapid-in, rapid-out, rapid-spin, chuck-all, and single-hand technology, magnetic

					
	1/4"	mm	4"	1/4"	mm
05052504001	1/4"	100	4"	1/4"	15,0

887/4 RR Rapidaptor Universal Bit Holder with ring magnet



Application: Suitable for 1/4" DIN ISO 1173-C 6,3 and E 6,3 hexagon insert bits and Wera Series 1 and 4

Design: Rapidaptor rapid-in, rapid-out, rapid-spin, chuck-all, and single-hand technology, with ring magnet and stop sleeve for secure screwdriving on the holder

Drive: 1/4" hexagon suitable for power tools with DIN ISO 1173-F 6,3 receiver

	1/4"	mm	mm	1/4"	mm
05052490001	1/4"	57	2 1/4"	1/4"	16
05160987001	1/4"	89	3 1/2"	1/4"	16
05160988001	1/4"	152	6"	1/4"	16

887/4 RR SB Rapidaptor Universal Bit Holder with ring magnet

		4013288
05073511001	⊙ 1 x 1/4"x57	105790



Tip

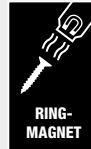

Rapidaptor ring magnet

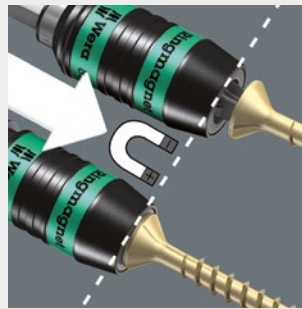

The floating, free-turning sleeve on the Rapidaptor with powerful ring magnet securely holds even large and heavy screws.

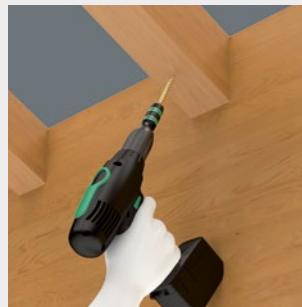

There is no need to hold the screw when applying the tool – something which can be dangerous and painful!



BiTorsion Quick-Release Chuck Holders

Adaptor for hexagon to square drive

797 A/4/1 B BiTorsion Bit Holder

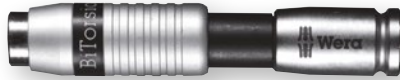

Application: Suitable for 1/4" DIN ISO 1173-C 6,3 and E 6,3 hexagon insert bits and Wera Series 1 and 4

Design: BiTorsion for long service life, with strong permanent magnet

Drive: 1/4"-female square socket for use with ratchet or power tool

	1/4"	mm	3"	1/4"	mm
05048681001	1/4"	77	3"	1/4"	14,0

797 B/4/1 B BiTorsion Bit Holder



Application: Suitable for 1/4" DIN ISO 1173-C 6,3 and E 6,3 hexagon insert bits and Wera Series 1 and 4

Design: BiTorsion for long service life, with strong permanent magnet

Drive: 3/8"-female square socket for use with ratchet or power tool

	1/4"	mm	3 1/4"	3/8"	mm
05048680001	1/4"	82	3 1/4"	3/8"	14,0

Universal Bit Holders with Quick-Release Chuck

Secure hold and rapid bit changes

894/4/1 K Universal Bit Holder



Application: Suitable for 1/4" DIN ISO 1173-C 6,3 hexagon insert bits and Wera Series 1

Design: With quick-release chuck

Drive: 1/4" hexagon, suitable for power tools with DIN ISO 1173-F 6,3 receiver

	mm	mm	mm	mm	mm
05053522001	1/4"	51	2"	1/4"	14,3

894/4/1 Universal Bit Holder



Application: Suitable for 1/4" DIN ISO 1173-C 6,3 hexagon insert bits and Wera Series 1

Design: With quick-release chuck

Drive: 1/4" hexagon, suitable for power tools with DIN ISO 1173-F 6,3 receiver

	mm	mm	mm	mm	mm
05053520001	1/4"	75	3"	1/4"	14,3

894/14/1 Universal Bit Holder



Application: Suitable for 1/4" DIN ISO 1173-C 6,3 hexagon insert bits and Wera Series 1

Design: With quick-release chuck

Drive: SDS plus

	mm	mm	mm	mm
05053560001	1/4"	75	3"	14,3

895/4/1 K Universal Bit Holder



Application: Suitable for 1/4" DIN ISO 1173-C 6,3 hexagon insert bits and Wera Series 1

Design: With strong permanent magnet and quick-release chuck

Drive: 1/4" hexagon, suitable for power tools with DIN ISO 1173-F 6,3 receiver

	mm	mm	mm	mm	mm
05053872001	1/4"	52	2"	1/4"	14,3

895/4/1 K SB Universal Bit Holder

05073318001	1 x 1/4"x52	4013288	029195	



Universal Bit Holder with Quick-Release Chuck

Secure hold and rapid bit changes

895/4/1 Universal Bit Holder



Application: Suitable for 1/4" DIN ISO 1173-C 6,3 hexagon insert bits and Wera Series 1

Design: With strong permanent magnet and quick-release chuck

Drive: 1/4" hexagon, suitable for power tools with DIN ISO 1173-F 6,3 receiver

		mm			mm
05053870001	1/4"	77	3"	1/4"	14,3

898/4 Combination Bit Holder



Application: Suitable for bits with 4 mm Halfmoon drive (and Wera Serie 9) and 4 mm HIOS drive (and Wera Series 21)

Design: With quick-release chuck

Drive: 1/4" hexagon, suitable for power tools with DIN ISO 1173-F 6,3 receiver

	mm			mm
05051500001	50	2"	1/4"	10,0

895/14/1 Universal Bit Holder



Application: Suitable for 1/4" DIN ISO 1173-C 6,3 hexagon insert bits and Wera Series 1

Design: With strong permanent magnet and quick-release chuck

Drive: SDS plus

		mm		mm
05053920001	1/4"	81	3 1/8"	14,3

898/9 Combination Bit Holder



Application: Suitable for bits with 4 mm Halfmoon drive (and Wera Serie 9) and 4 mm HIOS drive (and Wera Series 21)

Design: With quick-release chuck

Drive: Halfmoon, 4 mm

	mm		mm
05051501001	50	2"	10,0

898/21 Combination Bit Holder



Application: Suitable for bits with 4 mm Halfmoon drive (and Wera Serie 9) and 4 mm HIOS drive (and Wera Series 21)

Design: With quick-release chuck

Drive: HIOS 4 mm

	mm		mm
05051502001	50	2"	10,0





Universal Bit Holder with Retaining Ring

Proven, secure hold in series manufacturing applications

890/00/0 Universal Bit Holder





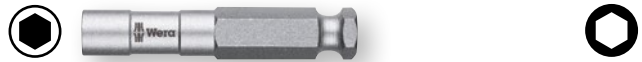

Application: Suitable for 4 mm DIN ISO 1173-C 4 bits
Design: With retaining ring
Drive: 3 mm hexagon, suitable for power tools with DIN ISO 1173-B 3 receiver

					
	mm	mm	mm	mm	mm
05052505001	4	57	2 1/4"	3	6,3

890/7/1 Universal Bit Holder







Application: Suitable for 1/4" DIN ISO 1173-C 6,3 hexagon insert bits and Wera Series 1
Design: With retaining ring
Drive: 7/16" hexagon, suitable for power tools with DIN ISO 1173-F 11,2 receiver

					
	mm	mm	mm	mm	mm
05052655001	1/4"	65	2 1/2"	7/16"	11,1

890/4/1 Universal Bit Holder





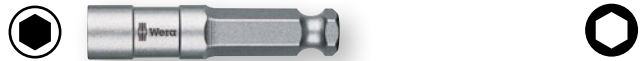

Application: Suitable for 1/4" DIN ISO 1173-C 6,3 hexagon insert bits and Wera Series 1
Design: With retaining ring
Drive: 1/4" hexagon, suitable for power tools with DIN ISO 1173-F 6,3 receiver

					
	mm	mm	mm	mm	mm
05052575001	1/4"	57	2 1/4"	1/4"	11,1

890/7/2 Universal Bit Holder







Application: Suitable for 5/16" DIN ISO 1173-C 8 hexagon insert bits and Wera Series 2
Design: With retaining ring
Drive: 7/16" hexagon, suitable for power tools with DIN ISO 1173-F 11,2 receiver

					
	mm	mm	mm	mm	mm
05052725001	5/16"	65	2 1/2"	7/16"	14,3

890/6/1 Universal Bit Holder



Application: Suitable for 1/4" DIN ISO 1173-C 6,3 hexagon insert bits and Wera Series 1
Design: With retaining ring
Drive: 5/16" hexagon, suitable for power tools with DIN ISO 1173-F 8 receiver

					
	mm	mm	mm	mm	mm
05052625001	1/4"	65	2 1/2"	5/16"	11,1



Universal Bit Holders with Stainless Steel Sleeve

Strong magnet for secure hold





893/4/1 K Universal Bit Holder



Application: Suitable for 1/4" DIN ISO 1173-C 6,3 hexagon insert bits and Wera Series 1

Design: With stainless steel sleeve and strong permanent magnet

Drive: 1/4" hexagon, suitable for power tools with DIN ISO 1173-F 6,3 receiver

					
	mm	mm	mm	mm	mm
05134480001	1/4"	50	2"	1/4"	10,5





899/3/1 Universal Bit Holder





Application: Suitable for 1/4" DIN ISO 1173-C 6,3 hexagon insert bits and Wera Series 1

Design: With stainless steel sleeve, retaining ring, and strong permanent magnet

Drive: 5.5 mm hexagon, suitable for power tools with DIN ISO 1173-B 5,5 receiver

					
	mm	mm	mm	mm	mm
05053425001	1/4"	72	2 3/4"	5,5	10,5

893/4/1 K SB Universal Bit Holder

		
05073401001	1 x 1/4"x50	4013288 029133







899/4/1 Universal Bit Holder





Application: Suitable for 1/4" DIN ISO 1173-C 6,3 hexagon insert bits and Wera Series 1

Design: With stainless steel sleeve, retaining ring, and strong permanent magnet

Drive: 1/4" hexagon, suitable for power tools with DIN ISO 1173-F 6,3 receiver

						
		mm	mm	mm	mm	mm
05053457001	899/4/1 K	1/4"	50	2"	1/4"	10,5
05053455001	899/4/1 75	1/4"	75	3"	1/4"	10,5
05053459001	899/4/1 100	1/4"	100	4"	1/4"	10,5
05053458001	899/4/1 152	1/4"	152	6"	1/4"	10,5

899/4/1 SB Universal Bit Holder

		
05347100001	1 x 899/4/1 K 50 1/4"x50	4013288 095268
05073357001	1 x 899/4/1 75 1/4"x75	029720
05134398001	1 x 899/4/1 152 1/4"x152	099907



899/4/1 S Universal Bit Holder with strong retaining ring



Application: Suitable for 1/4" DIN ISO 1173-C 6,3 hexagon insert bits and Wera Series 1

Design: With stainless steel sleeve, strong retaining ring, and strong permanent magnet

Drive: 1/4" hexagon, suitable for power tools with DIN ISO 1173-F 6,3 receiver

	1/4"	mm	mm	1/4"	mm
05160976001	1/4"	50	2"	1/4"	10,5
05160924001	1/4"	75	3"	1/4"	10,5
05160977001	1/4"	100	4"	1/4"	10,5
05160979001	1/4"	200	8"	1/4"	10,5
05160981001	1/4"	300	12"	1/4"	10,5

899/8/1 Universal Bit Holder



Application: Suitable for 1/4" DIN ISO 1173-C 6,3 hexagon insert bits and Wera Series 1

Design: With stainless steel sleeve, retaining ring, and strong permanent magnet

Drive: 7 mm, suitable for power tools with DIN ISO 1173-H 7 receiver

	1/4"	mm	mm	mm	mm
05053475001	1/4"	75	3"	7	10,5

899/5/1 Universal Bit Holder



Application: Suitable for 1/4" DIN ISO 1173-C 6,3 hexagon insert bits and Wera Series 1

Design: With stainless steel sleeve, retaining ring, and strong permanent magnet

Drive: 5/16" hexagon

	1/4"	mm	mm	5/16"	mm
05053460001	1/4"	45	1 3/4"	5/16"	10,5

899/8/1 K Universal Bit Holder



Application: Suitable for 1/4" DIN ISO 1173-C 6,3 hexagon insert bits and Wera Series 1

Design: With stainless steel sleeve, retaining ring, and strong permanent magnet

Drive: 7 mm, suitable for power tools with DIN ISO 1173-H 7 receiver

	1/4"	mm	mm	mm	mm
05053480001	1/4"	55	2 3/16"	7	10,5

899/14/1 Universal Bit Holder



Application: Suitable for 1/4" DIN ISO 1173-C 6,3 hexagon insert bits and Wera Series 1

Design: With stainless steel sleeve, retaining ring, and strong permanent magnet

Drive: SDS plus

	1/4"	mm	mm	mm	mm
05053485001	1/4"	79	3 1/8"	10,5	10,5

899/14/1 SB Universal Bit Holder

05134397001	●	1 x 1/4"x79	4013288 099891



Universal Bit Holders with Copper Beryllium Sleeve

Very high torque model



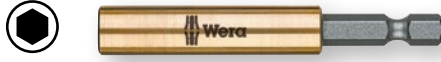

891/4/1 Universal Bit Holder



Application: Suitable for 1/4" DIN ISO 1173-C 6,3 hexagon insert bits and Wera Series 1

Design: With CuBe sleeve, retaining ring, and strong permanent magnet

Drive: 1/4" hexagon, suitable for power tools with DIN ISO 1173-F 6,3 receiver

		 mm	 mm		 mm
05053175001	1/4"	75	3"	1/4"	10,5





891/8/1 Universal Bit Holder



Application: Suitable for 1/4" DIN ISO 1173-C 6,3 hexagon insert bits and Wera Series 1

Design: With CuBe sleeve, retaining ring, and strong permanent magnet

Drive: 7 mm, suitable for power tools with DIN ISO 1173-H 7 receiver

		 mm	 mm	 mm	 mm
05053275001	1/4"	75	3"	7	10,5

Bit Holder with Adjustable Depth-Control Stop

With infinite adjustment feature



896/4/1 SB Bit Holder with adjustable depth-control stop



Application: Suitable for 1/4" DIN ISO 1173-C 6,3 hexagon insert bits and Wera Series 1

Design: High quality aluminium spacers with infinite adjustment feature

Drive: 1/4" hexagon, suitable for power tools with DIN ISO 1173-F 6,3 receiver

		
05073210001	896/4/1	4013288
	⊙ 1 x 1/4"x50	178725

Tip

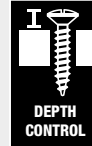

Bit holder with adjustable depth stop



The screw installation depth can be infinitely adjusted and allows the desired degree of countersinking of the screws.



Adaptors

870/1 Adaptor



Application: Nut spinner sockets
Drive: 1/4" external hexagon
Output: 1/4" external square

		mm		
05136000001 ¹⁾	1/4"	25	1"	1/4"

¹⁾ With friction ball; for manual nut spinner sockets

870/2 Adaptor



Application: Nut spinner sockets
Drive: External hexagon
Output: External square

		mm		
05136001001 ¹⁾	3/8"	30	1 3/16"	5/16"
05136002001 ¹⁾	1/2"	35	1 3/8"	5/16"

¹⁾ With friction ball; for manual nut spinner sockets

870/4 Adaptor



Application: Manual nut spinner sockets
Drive: 1/4" hexagon
Output: 1/4" external square

		mm		
05311517001 ¹⁾	1/4"	50	2"	1/4"

¹⁾ With friction ball; for manual nut spinner sockets

870/4 SB

05134399001 ¹⁾	OO	1 x 1/4"x50		099914

¹⁾ With friction ball; for manual nut spinner sockets



870/4/7 Set A SB



Application: Machine-operated nut spinner sockets

Design: With external square drive

Drive: 1/4" hexagon, suitable for power tools with DIN ISO 1173-F 6,3 receiver; 7/16" hexagon, suitable for power tools with DIN ISO 1173-F 11,2 receiver

0507320001		
870/4	1 x 1/4"x50; 1 x 3/8"x50	
870/7	1 x 1/2"x75	

870/4 Adaptor



Application: Machine-operated nut spinner sockets

Design: With external square drive

Drive: 1/4" hexagon, suitable for power tools with DIN ISO 1173-F 6,3 receiver

		mm		
05050205001	1/4"	50	2"	1/4"
05050210001	1/4"	100	4"	1/4"
05050215001	3/8"	50	2"	1/4"
05050220001	3/8"	100	4"	1/4"

870/14 Adaptor



Application: Machine-operated nut spinner sockets

Design: With external square drive

Drive: SDS plus

		mm	
05050650001	1/4"	70	2 3/4"

870/7 Adaptor



Application: Machine-operated nut spinner sockets

Design: With external square drive

Drive: 7/16" hexagon, suitable for power tools with DIN ISO 1173-F 11,2 receiver

		mm		
05050510001	1/2"	75	3"	7/16"



Adaptors

784 A 1/4" Adaptor with quick-release chuck



Application: Suitable for 1/4" DIN ISO 1173-C 6,3 hexagon insert bits and Wera Series 1

Design: With Wera quick-release chuck

Drive: 1/4" female square

05042750001	784 A/1	1/4"	30	1 3/16" 1/4"

784 B 3/8" Adaptor with quick-release chuck



Application: Suitable for 1/4" DIN ISO 1173-C 6,3 and 5/16" DIN ISO 1173-C 8 hexagon insert bits and Wera Series 1 and 2

Design: With Wera quick-release chuck

Drive: 3/8" female square

05042755001	784 B/1	1/4"	43	1 5/8" 3/8"
05042765001	784 B/2	5/16"	50	2" 3/8"

784 C 1/2" Adaptor with quick-release chuck



Application: Suitable for 1/4" DIN ISO 1173-C 6,3 and 5/16" DIN ISO 1173-C 8 hexagon insert bits and Wera Series 1 and 2

Design: With Wera quick-release chuck

Drive: 1/2" female square

05042760001	784 C/1	1/4"	50	2" 1/2"
05042768001	784 C/2	5/16"	50	2" 1/2"

780 A 1/4" Adaptor



Application: Suitable for 1/4" DIN ISO 1173-C 6,3 hexagon insert bits and Wera Series 1

Drive: 1/4" female square

05042605001	780 A/1	1/4"	25	1" 1/4"

780 B 3/8" Adaptor



Application: Suitable for 1/4" DIN ISO 1173-C 6,3 and 5/16" DIN ISO 1173-C 8 hexagon insert bits and Wera Series 1 and 2

Drive: 3/8" female square

05042655001	780 B/1	1/4"	30	1 3/16" 3/8"
05344511001 ¹⁾	780 B/1-S	1/4"	30	1 3/16" 3/8"
05042665001	780 B/2	5/16"	30	1 3/16" 3/8"
05344512001 ¹⁾	780 B/2-S	5/16"	30	1 3/16" 3/8"

¹⁾ S = extra strong

780 C 1/2" Adaptor



Application: Suitable for 1/4" DIN ISO 1173-C 6,3, 5/16" DIN ISO 1173-C 8, 7/16" DIN ISO 1173-E 11,2, 5/8" hexagon insert bits and Wera Series 1, 2, 6, 7 and 19









Drive: 1/2" female square

05042705001	780 C/1	1/4"	35	1 3/8" 1/2"
05344513001	780 C/1-S	1/4"	35	1 3/8" 1/2"
05042715001	780 C/2	5/16"	35	1 3/8" 1/2"
05344514001	780 C/2-S	5/16"	35	1 3/8" 1/2"





Bit Sets

	Bit-Checks Impaktor	434
	Bit-Checks Stainless	438
	Bit-Checks / Bit-Safes BiTorsion	440
	Bit-Checks Diamond	444
	Bit-Checks / Bit-Safes Universal	448
	Bit-Checks Wood	458
	Bit-Checks Metal	460
	Bit Sets For Special Applications	461



Bit Ranges

We have had bit ranges in our programme for many years now. In 2016, we put a question mark against everything and came up with a game changer.

We wanted bit ranges with bits whose profiles and sizes could be more easily recognised. We wanted bit ranges that were as compact as possible and which were Wera-like at a first glance. We wanted bit ranges with bits that could be removed and reinserted more easily. We wanted bit ranges with as little weight as possible. The new multi-component Bit-Checks satisfy these requirements; the soft material in the lower section of the Bit-Checks ensures that the bits are firmly held yet easy to remove.



The bit ranges comprise sets of between 6 and 61 pieces. They offer the right tool set for every user.



The Bit-Checks by Wera are extremely compact and are therefore the ideal companion for mobile applications.



The Bit-Checks can be positioned upright at the workplace so the tool is always quickly to hand.

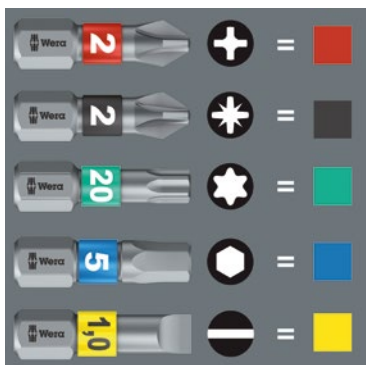

The “Take it easy” Bit-Checks have bits with a sleeve which – from its colour (e.g. red = Phillips) and size designation – make it simple to access the right bit quickly.



The new Bit-Safes provide users with comprehensive bit and holder ranges in a surface-protecting, compact textile box.



Bit-Checks Impaktor

For an above-average service life

Bit-Check 30 Impaktor 1



1 Impaktor holder with retaining ring and ring magnet in the chuck for a secure fit of the bits in the holder, 29 Impaktor bits. The "Take it easy" Bit-Checks have bits with a sleeve which – from its colour and size designation – make it simple to access the right bit quickly.

05057690001	
●○	897/4 1 x 1/4"x75 Impaktor R
+	851/1 IMP DC 2 x PH 1x25; 3 x PH 2x25; 2 x PH 3x25
+	855/1 IMP DC 2 x PZ 1x25; 3 x PZ 2x25; 2 x PZ 3x25
⊕	867/1 IMP DC 1 x TX 10x25; 1 x TX 15x25; 2 x TX 20x25; 3 x TX 25x25; 2 x TX 30x25; 2 x TX 40x25
○	840/1 IMP DC 1 x 3,0x25; 1 x 4,0x25; 1 x 5,0x25; 1 x 6,0x25

Bit-Check 10 Impaktor 1



1 Impaktor holder with retaining ring and ring magnet in the chuck for a secure fit of the bits in the holder, 9 Impaktor bits. The "Take it easy" Bit-Checks have bits with a sleeve which – from its colour and size designation – make it simple to access the right bit quickly.

05057680001	
●○	897/4 1 x 1/4"x75 Impaktor R
+	851/1 IMP DC 1 x PH 2x25; 1 x PH 3x25
+	855/1 IMP DC 1 x PZ 2x25; 1 x PZ 3x25
⊕	867/1 IMP DC 1 x TX 20x25; 1 x TX 25x25; 1 x TX 30x25
○	840/1 IMP DC 1 x 4,0x25; 1 x 5,0x25

Bit-Check 10 Impaktor 2



1 Impaktor holder with retaining ring and ring magnet in the chuck for a secure fit of the bits in the holder, 9 Impaktor bits. The "Take it easy" Bit-Checks have bits with a sleeve which – from its colour and size designation – make it simple to access the right bit quickly.

05057682001	
●○	897/4 1 x 1/4"x75 Impaktor R
+	851/1 IMP DC 3 x PH 2x25; 1 x PH 3x25
⊕	867/1 IMP DC 3 x TX 25x25; 1 x TX 30x25; 1 x TX 40x25

Bit-Check 10 Impaktor 1 SB

		4013288
05073980001		158574
●○	897/4 Impaktor R 1 x 1/4"x75	
+	851/1 IMP DC 1 x PH 2x25; 1 x PH 3x25	
+	855/1 IMP DC 1 x PZ 2x25; 1 x PZ 3x25	
⊕	867/1 IMP DC 1 x TX 20x25; 1 x TX 25x25; 1 x TX 30x25	
○	840/1 IMP DC 1 x 4,0x25; 1 x 5,0x25	



Bit-Check 10 Impaktor 3



1 Impaktor holder with retaining ring and ring magnet in the chuck for a secure fit of the bits in the holder, 9 Impaktor bits. The "Take it easy" Bit-Checks have bits with a sleeve which – from its colour and size designation – make it simple to access the right bit quickly.

05057683001	
●○	897/4 1 x 1/4"x75 Impaktor R
+	855/1 IMP DC 3 x PZ 2x25; 1 x PZ 3x25
⊕	867/1 IMP DC 3 x TX 25x25; 1 x TX 30x25; 1 x TX 40x25

Bit-Check 10 Impaktor 4



1 Impaktor holder with retaining ring and magnet in the chuck for a secure fit of the bits in the holder, 9 Impaktor bits. The “Take it easy” Bit-Checks have bits with a sleeve which – from its colour and size designation – make it simple to access the right bit quickly.

05057417001	
● ○	897/4 1 x 1/4"x75
	Impaktor
+	855/1 IMP DC 3 x PZ 2x25; 1 x PZ 3x25
+	867/1 IMP DC 2 x TX 20x25; 2 x TX 25x25; 1 x TX 30x25

Bit-Check 10 PZ Impaktor 1



1 Impaktor holder with retaining ring and ring magnet in the chuck for a secure fit of the bits in the holder, 9 Impaktor bits. The “Take it easy” Bit-Checks have bits with a sleeve which – from its colour and size designation – make it simple to access the right bit quickly.

05057684001	
● ○	897/4 1 x 1/4"x75
	Impaktor R
+	855/1 IMP DC 7 x PZ 2x25; 2 x PZ 3x25

Bit-Check 10 TX Impaktor 1



1 Impaktor holder with retaining ring and ring magnet in the chuck for a secure fit of the bits in the holder, 9 Impaktor bits. The “Take it easy” Bit-Checks have bits with a sleeve which – from its colour and size designation – make it simple to access the right bit quickly.

05057688001	
● ○	897/4 1 x 1/4"x75
	Impaktor R
+	867/1 IMP DC 3 x TX 20x25; 3 x TX 25x25; 2 x TX 30x25; 1 x TX 40x25

Tip



Impaktor-Bits



Impact-Bits are needed when a strong power tool (e.g. 18 volt impact screwdriver) is used. Impact bits were specifically developed to withstand high power tool forces.

The Impaktor stainless steel holder with a retaining ring and magnet



The Impaktor stainless steel holder with a retaining ring and magnet satisfies the extreme, dynamic requirements in that there are consciously no small mechanical component parts fitted as they would be more susceptible to failure. It focuses on the basic bit holding function and the cushioning of the extreme impulse peaks with its two different torsion zones. Mainly used in industrial screw assembly applications e.g. with screwdriving robots.

The Impaktor holder with ring magnet



The Impaktor holder with ring magnet additionally holds longer and heavier screws absolutely securely. This enables a speedy and dependable positioning of the screw. It is also ideal for above-head work. Should the magnet function not be required in a particular situation e.g. when working with metal, it can be extracted from the screwdriving area and can thereby be “disabled”. Mainly used in manual power tool applications.



Bit-Checks Impaktor

For an above-average service life

Bit-Check 6 Impaktor 1



6 Impaktor bits.

The "Take it easy" Bit-Checks have bits with a sleeve which – from its colour and size designation – make it simple to access the right bit quickly.

05057695001	
+	851/4 IMP DC 1 x PH 2x50; 1 x PH 3x50
+	855/4 IMP DC 1 x PZ 2x50; 1 x PZ 3x50
+	867/4 IMP DC 1 x TX 25x50; 1 x TX 30x50

Bit-Check 6 PH Impaktor 1



6 Impaktor bits.

The "Take it easy" Bit-Checks have bits with a sleeve which – from its colour and size designation – make it simple to access the right bit quickly.

05057691001	
+	851/4 IMP DC 4 x PH 2x50; 2 x PH 3x50

Bit-Check 6 Impaktor 1 SB

		4013288
05073890001		158635
+	851/4 IMP DC	
	1 x PH 2x50; 1 x PH 3x50	
+	855/4 IMP DC	
	1 x PZ 2x50; 1 x PZ 3x50	
+	867/4 IMP DC	
	1 x TX 25x50; 1 x TX 30x50	



Bit-Check 6 PZ Impaktor 1



6 Impaktor bits.

The "Take it easy" Bit-Checks have bits with a sleeve which – from its colour and size designation – make it simple to access the right bit quickly.

05057692001	
+	855/4 IMP DC 4 x PZ 2x50; 2 x PZ 3x50

Bit-Check 6 Impaktor 2



6 Impaktor bits.

The "Take it easy" Bit-Checks have bits with a sleeve which – from its colour and size designation – make it simple to access the right bit quickly.

05057694001	
+	851/4 IMP DC 1 x PH 2x50; 1 x PH 3x50
+	867/4 IMP DC 1 x TX 25x50; 1 x TX 30x50
+	868/4 IMP DC 1 x # 2x50; 1 x # 3x50

Bit-Check 6 TX Impaktor 1



6 Impaktor bits.

The "Take it easy" Bit-Checks have bits with a sleeve which – from its colour and size designation – make it simple to access the right bit quickly.

05057693001	
+	867/4 IMP DC 2 x TX 20x50; 2 x TX 25x50; 1 x TX 30x50; 1 x TX 40x50



” To learn more about this product, scan the QR code. “



Bit-Checks Stainless

Keep rust at bay

Bit-Check 30 Stainless 1



1 Rapidaptor stainless steel bit holder with quick-release chuck, 29 stainless steel bits.

The "Take it easy" Bit-Checks have bits with a sleeve which – from its colour and size designation – make it simple to access the right bit quickly.

05071109001	
●○	3888/4/1 K 1 x 1/4"x50
+	3851/1 TS PH 1 x PH 1x25; 3 x PH 2x25; 1 x PH 3x25
+	3855/1 TS PZ 2 x PZ 1x25; 3 x PZ 2x25; 1 x PZ 3x25
⊗	3867/1 TS 2 x TX 10x25; 2 x TX 15x25; 3 x TX 20x25; TORX® 3 x TX 25x25; 2 x TX 30x25; 1 x TX 40x25
○	3840/1 TS 1 x 2,5x25; 1 x 3,0x25; 1 x 4,0x25; 1 x 5,0x25; 1 x 5,5x25

Bit-Check 10 Stainless 1



1 Rapidaptor stainless steel bit holder with quick-release chuck, 9 stainless steel bits.

The "Take it easy" Bit-Checks have bits with a sleeve which – from its colour and size designation – make it simple to access the right bit quickly.

05071110001	
●○	3888/4/1 K 1 x 1/4"x50
+	3851/1 TS PH 1 x PH 2x25
+	3855/1 TS PZ 1 x PZ 1x25; 2 x PZ 2x25
⊗	3867/1 TS 1 x TX 10x25; 1 x TX 15x25; 1 x TX 20x25; TORX® 1 x TX 25x25; 1 x TX 30x25

Bit-Check 12 Stainless 1



1 Rapidaptor stainless steel bit holder with quick-release chuck, 11 stainless steel bits.

The "Take it easy" Bit-Checks have bits with a sleeve which – from its colour and size designation – make it simple to access the right bit quickly.

05057425001	
●○	3888/4/1 K 1 x 1/4"x50
+	3851/1 TS PH 1 x PH 1x25; 1 x PH 2x25
+	3855/1 TS PZ 1 x PZ 1x25; 1 x PZ 2x25
⊗	3867/1 TS 1 x TX 15x25; 1 x TX 20x25; 1 x TX 25x25; TORX® 1 x TX 30x25
○	3840/1 TS 1 x 3,0x25; 1 x 4,0x25; 1 x 5,0x25

Bit-Check 10 Stainless 1 SB

05073630001	4013288 112163
●○	3888/4/1 K 1 x 1/4"x50
+	3851/1 TS PH 1 x PH 2x25
+	3855/1 TS PZ 1 x PZ 1x25; 2 x PZ 2x25
⊗	3867/1 TS TORX® 1 x TX 10x25; 1 x TX 15x25; 1 x TX 20x25; 1 x TX 25x25; 1 x TX 30x25







Bit-Check 6 Stainless 1 SB



6 stainless steel bits.

The "Take it easy" Bit-Checks have bits with a sleeve which – from its colour and size designation – make it simple to access the right bit quickly.

		
05073634001	3855/4 	2 x PZ 2x50 164636
	3867/4 TORX® 	1 x TX 20x50; 2 x TX 25x50
	3840/4 Hex-Plus 	1 x 5.5x50

Tip



Stainless Steel Bits



The stainless steel tools from Wera are vacuum ice-hardened and have the hardness and strength needed for screw connections. There are no limitations to the industrial applications they are suitable for.



"Take it easy"



"Take it easy" tool finder with colour coding according to profiles and size stamp – for simple and rapid accessing of the required tool.



Rapidaptor holder out of stainless steel



Manufactured out of stainless steel thus preventing the formation of unsightly extraneous rust when working with stainless steel. Additionally, it offers all the advantages of the Rapidaptor technology.



Bit-Checks / Bit-Safes BiTorsion

BiTorsion – Distinct extension of service life

Bit-Safe 61 BiTorsion 1



1 bit holder Rapidaptor with quick-release chuck, 49 BiTorsion bits for long service life, diamond-coated (BDC) for secure screw fit, tough (BTZ), for universal use, extra-hard (BTH).

The "Take it easy" Bit-Safes have bits with a sleeve which – from its colour and size designation – make it simple to access the right bit quickly.

05057441001	
⊙ ⊙	889/4/1 K 1 x 1/4"x50
⊕	851/1 BDC PH 1 x PH 1x25; 2 x PH 2x25; 1 x PH 3x25
⊕	851/1 BTZ PH 2 x PH 1x25; 8 x PH 2x25; 1 x PH 3x25
⊕	855/1 BDC PZ 1 x PZ 1x25; 2 x PZ 2x25; 1 x PZ 3x25
⊕	855/1 BTH PZ 2 x PZ 1x25; 8 x PZ 2x25; 1 x PZ 3x25
⊕	867/1 TORX® 3 x TX 10x25; 2 x TX 15x25; 4 x TX 20x25; BTZ 4 x TX 25x25; 2 x TX 30x25; 1 x TX 40x25
⊖	800/1 BDC 1 x 0,8x5,5x25; 1 x 1,0x5,5x25; 1 x 1,2x6,5x25
⊙	840/1 BTZ Hex-Plus 3 x 2,5x25; 3 x 3,0x25; 3 x 4,0x25; 2 x 5,0x25

Bit-Check 30 BiTorsion 1



1 bit holder Rapidaptor with quick-release chuck, 29 BiTorsion bits for long service life, tough, for universal use.

The "Take it easy" Bit-Checks have bits with a sleeve which – from its colour and size designation – make it simple to access the right bit quickly.

05057430001	
⊙ ⊙	889/4/1 K 1 x 1/4"x50
⊕	851/1 BTZ PH 2 x PH 1x25; 5 x PH 2x25; 2 x PH 3x25
⊕	855/1 BTZ PZ 2 x PZ 1x25; 6 x PZ 2x25; 2 x PZ 3x25
⊕	867/1 TORX® 1 x TX 10x25; 2 x TX 15x25; 2 x TX 20x25; BTZ 2 x TX 25x25; 2 x TX 30x25; 1 x TX 40x25

Bit-Check 12 BiTorsion 1



1 bit holder Rapidaptor with quick-release chuck, 11 BiTorsion bits for long service life, tough, for universal use.

The "Take it easy" Bit-Checks have bits with a sleeve which – from its colour and size designation – make it simple to access the right bit quickly.

05057420001	
⊙ ⊙	889/4/1 K 1 x 1/4"x50
⊕	851/1 BTZ PH 1 x PH 1x25; 2 x PH 2x25
⊕	855/1 BTZ PZ 1 x PZ 1x25; 2 x PZ 2x25
⊕	867/1 TORX® 1 x TX 10x25; 1 x TX 15x25; 1 x TX 20x25; BTZ 1 x TX 25x25; 1 x TX 30x25

Bit-Check 10 BiTorsion 1



1 BiTorsion bit holder Rapidaptor with quick-release chuck, 9 BiTorsion bits for long service life, tough, for universal use. The "Take it easy" Bit-Checks have bits with a sleeve which – from its colour and size designation – make it simple to access the right bit quickly.

05056374001	
●○	897/4 R 1 x 1/4"x75
⊕	851/1 BTZ PH 1 x PH 1x25; 1 x PH 2x25; 1 x PH 3x25
⊕	855/1 BTZ PZ 1 x PZ 1x25; 1 x PZ 2x25; 1 x PZ 3x25
●	800/1 BTZ 1 x 0,8x5,5x25; 1 x 1,0x5,5x25; 1 x 1,2x6,5x25

Bit-Check 10 BiTorsion 2

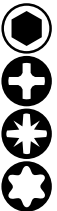

1 BiTorsion bit holder Rapidaptor with quick-release chuck, 9 BiTorsion bits for long service life, tough, for universal use. The "Take it easy" Bit-Checks have bits with a sleeve which – from its colour and size designation – make it simple to access the right bit quickly.

05057117001	
●○	897/4 R 1 x 1/4"x75
⊕	851/1 BTZ PH 1 x PH 2x25
⊕	855/1 BTZ PZ 1 x PZ 1x25; 2 x PZ 2x25
⊕	867/1 TORX® 1 x TX 10x25; 1 x TX 15x25; 1 x TX 20x25; 1 x TX 25x25; 1 x TX 30x25

Tip



BiTorsion

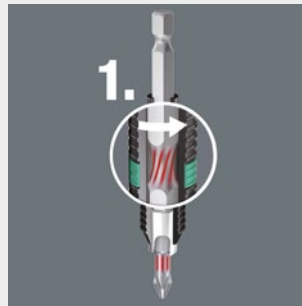

The effectiveness of the BiTorsion system comes from a combination of two shock-absorbing spring elements.

Both bits as well as holders have a cushioning torsion zone that diverts the kinetic energy away from the drive tip during peak loads.



BDC-Bits



BDC-Bits are absolutely premium products. They have a softer BiTorsion zone which reduces the hardness of the shaft by about 20 % in comparison to the drive tip. This means that the peak loads that cause bit breakage and premature wear are absorbed in this zone – something which enhances the service life of the bits.

The diamond coating lowers the danger of slipping as the minute diamond particles literally "bite" themselves into the screw head. B stands for BiTorsion. DC stands for diamond coated.



"Take it easy"

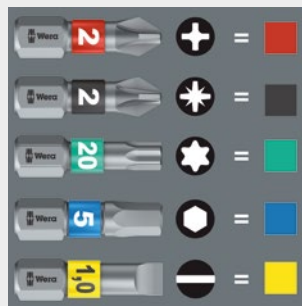

"Take it easy" tool finder with colour coding according to profiles and size stamp – for simple and rapid accessing of the required tool.



Bit-Checks / Bit-Safes BiTorsion

BiTorsion – Distinct extension of service life

Bit-Check 10 BiTorsion 3 SB



1 BiTorsion bit holder Rapidaptor with quick-release chuck, 9 BiTorsion bits for long service life, tough, for universal use. The “Take it easy” Bit-Checks have bits with a sleeve which – from its colour and size designation – make it simple to access the right bit quickly.

			4013288
05073418001	897/4 R	●○ 1 x 1/4"x75	128157
	851/1 BTZ PH	⊕ 1 x PH 2x25	
	855/1 BTZ PZ	⊕ 1 x PZ 1x25; 1 x PZ 2x25; 1 x PZ 3x25	
	867/1 TORX® BTZ	⊕ 1 x TX 10x25; 1 x TX 15x25; 1 x TX 20x25; 1 x TX 25x25; 1 x TX 30x25	

Bit-Check 10 PZ BiTorsion 1



1 BiTorsion bit holder Rapidaptor with quick-release chuck, 9 BiTorsion bits for long service life, tough, for universal use. The “Take it easy” Bit-Checks have bits with a sleeve which – from its colour and size designation – make it simple to access the right bit quickly.

05056368001			
	●○ 897/4 R	1 x 1/4"x75	
	⊕ 855/1 BTZ PZ	7 x PZ 2x25; 2 x PZ 3x25	

Bit-Check 10 PZ BiTorsion 2



1 BiTorsion bit holder Rapidaptor with quick-release chuck, 9 BiTorsion bits for long service life, extra-hard. The “Take it easy” Bit-Checks have bits with a sleeve which – from its colour and size designation – make it simple to access the right bit quickly.

05347153001			
	●○ 897/4 R	1 x 1/4"x75	
	⊕ 855/1 BTH PZ	1 x PZ 1x25; 7 x PZ 2x25; 1 x PZ 3x25	

Bit-Check 7 PZ BiTorsion 1



1 bit holder Rapidaptor with quick-release chuck suitable, 6 BiTorsion bits for long service life, extra-hard. The “Take it easy” Bit-Checks have bits with a sleeve which – from its colour and size designation – make it simple to access the right bit quickly.

05340260001			
	●○ 889/4/1 K	1 x 1/4"x50	
	⊕ 855/1 BTH PZ	1 x PZ 1x25; 4 x PZ 2x25; 1 x PZ 3x25	

Bit-Check 7 PH BiTorsion 1



1 universal bit holder with stainless steel sleeve and strong permanent magnet, 6 BiTorsion bits for long service life, extra-hard. The "Take it easy" Bit-Checks have bits with a sleeve which – from its colour and size designation – make it simple to access the right bit quickly.

05056291001	
● ○	893/4/1 K 1 x 1/4"x50
⊕	851/1 BTH PH 6 x PH 2x25

Bit-Check 6 PH BiTorsion 1



6 BiTorsion bits for long service life, extra-hard. The "Take it easy" Bit-Checks have bits with a sleeve which – from its colour and size designation – make it simple to access the right bit quickly.

05056477001	
⊕	851/4 BTH PH 6 x PH 2x50

Tip



BiTorsion



The BiTorsion holder and the Bi-Torsion bit can, of course, be used independently of one another.

Chuck-all



The Rapidaptor quick-release chucks hold both 1/4" bits as per DIN ISO 1173-C 6,3 (Wera series 1) and E 6,3 (Wera series 4).

Rapid-in and self-lock

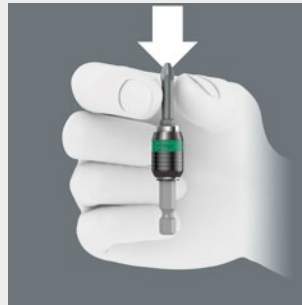

The bit can be pushed into the chuck without moving the sleeve. It automatically locks with a secure and wobble-free fit as soon as the bit is applied to the screw.

Rapid-out



Simply push the sleeve forward to change the bit. The spring mechanism lifts the bit off the magnet and unlocks the tool. The bit can be easily removed. Particularly helpful: even the smallest bits can be removed without any extra tools.



Bit-Checks Diamond

Bits with "bite"

Bit-Check 30 Diamond 1



1 bit holder Rapidaptor with quick-release chuck, 29 BiTorsion bits for long service life, diamond-coated (BDC) for secure screw fit. The "Take it easy" Bit-Checks have bits with a sleeve which – from its colour and size designation – make it simple to access the right bit quickly.

05057431001	
● ○	889/4/1 K 1 x 1/4"x50
+	851/1 BDC PH 2 x PH 1x25; 4 x PH 2x25; 1 x PH 3x25
+	855/1 BDC PZ 2 x PZ 1x25; 4 x PZ 2x25; 1 x PZ 3x25
+	867/1 TORX® 2 x TX 10x25; 2 x TX 15x25; 3 x TX 20x25; BDC 3 x TX 25x25; 1 x TX 30x25; 1 x TX 40x25
●	800/1 BDC 1 x 0,8x5,5x25; 1 x 1,0x5,5x25; 1 x 1,2x6,5x25

Bit-Check 10 Diamond 1



1 BiTorsion bit holder Rapidaptor with quick-release chuck, 9 BiTorsion bits for long service life, diamond-coated (BDC) for secure screw fit. The "Take it easy" Bit-Checks have bits with a sleeve which – from its colour and size designation – make it simple to access the right bit quickly.

05057116001	
● ○	897/4 R 1 x 1/4"x75
+	851/1 BDC PH 1 x PH 2x25
+	855/1 BDC PZ 1 x PZ 1x25; 2 x PZ 2x25
+	867/1 TORX® 1 x TX 10x25; 1 x TX 15x25; 1 x TX 20x25; BDC 1 x TX 25x25; 1 x TX 30x25

Bit-Check 12 Diamond 1



1 bit holder Rapidaptor with quick-release chuck, 11 BiTorsion bits for long service life, diamond-coated (BDC) for secure screw fit. The "Take it easy" Bit-Checks have bits with a sleeve which – from its colour and size designation – make it simple to access the right bit quickly.

05057421001	
● ○	889/4/1 K 1 x 1/4"x50
+	851/1 BDC PH 1 x PH 1x25; 2 x PH 2x25
+	855/1 BDC PZ 1 x PZ 1x25; 2 x PZ 2x25
+	867/1 TORX® 1 x TX 10x25; 1 x TX 15x25; 1 x TX 20x25; BDC 1 x TX 25x25; 1 x TX 30x25

Bit-Check 7 Diamond 1



1 bit holder Rapidaptor with quick-release chuck, 6 BiTorsion bits for long service life, diamond-coated (BDC) for secure screw fit. The "Take it easy" Bit-Checks have bits with a sleeve which – from its colour and size designation – make it simple to access the right bit quickly.

05057416001	
⊙	889/4/1 K 1 x 1/4"x50
+	851/1 BDC PH 1 x PH 1x25; 1 x PH 2x25
+	855/1 BDC PZ 1 x PZ 1x25; 1 x PZ 2x25
●	800/1 BDC 1 x 1,0x5,5x25; 1 x 1,2x6,5x25

Bit-Check 7 Diamond 1 SB

	4013288
05073419001	183682
⊙	889/4/1 K 1 x 1/4"x50
+	851/1 BDC PH 1 x PH 1x25; 1 x PH 2x25
+	855/1 BDC PZ 1 x PZ 1x25; 1 x PZ 2x25
●	800/1 BDC 1 x 1,0x5,5x25; 1 x 1,2x6,5x25



Tip



BDC-Bits



BDC-Bits are absolutely premium products. They have a softer BiTorsion zone which reduces the hardness of the shaft by about 20 % in comparison to the drive tip. This means that the peak loads that cause bit breakage and premature wear are absorbed in this zone – something which enhances the service life of the bits. The diamond coating lowers the danger of slipping as the minute diamond particles literally "bite" themselves into the screw head. B stands for BiTorsion. DC stands for diamond coated.



"Take it easy"

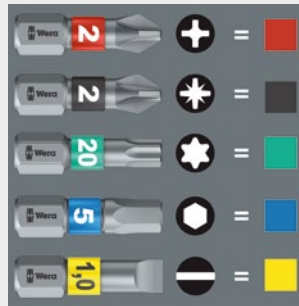

"Take it easy" tool finder with colour coding according to profiles and size stamp – for simple and rapid accessing of the required tool.



BiTorsion Rapidaptor



BiTorsion bit holders are suitable for all bits in accordance with C 6,3 and E 6,3. The optimally coordinated features of the torsion zones on the BiTorsion bits and BiTorsion holder permit a phased yield when under strain. This two-phase system prevents premature wear. The bits and the holder can be used independently of one another. A long tool service life is guaranteed when both elements are used.



Bit-Checks Diamond

Bits with "bite"

Bit-Check 7 PZ Diamond 1



1 bit holder Rapidaptor with quick-release chuck, 6 BiTorsion bits for long service life, diamond-coated (BDC) for secure screw fit. The "Take it easy" Bit-Checks have bits with a sleeve which – from its colour and size designation – make it simple to access the right bit quickly.

05057412001	
● ○	889/4/1 K 1 x 1/4"x50
⊕	855/1 BDC PZ 2 x PZ 1x25; 3 x PZ 2x25; 1 x PZ 3x25

Bit-Check 7 PH Diamond 1



1 bit holder Rapidaptor with quick-release chuck, 6 BiTorsion bits for long service life, diamond-coated (BDC) for secure screw fit. The "Take it easy" Bit-Checks have bits with a sleeve which – from its colour and size designation – make it simple to access the right bit quickly.

05057414001	
● ○	889/4/1 K 1 x 1/4"x50
⊕	851/1 BDC PH 2 x PH 1x25; 3 x PH 2x25; 1 x PH 3x25

Bit-Check 7 PZ Diamond 1 SB

05073534001		4013288 180940
● ○	889/4/1 K 1 x 1/4"x50	
⊕	855/1 BDC PZ 2 x PZ 1x25; 3 x PZ 2x25; 1 x PZ 3x25	



Bit-Check 7 TX Diamond 1



1 bit holder Rapidaptor with quick-release chuck, 6 BiTorsion bits for long service life, diamond-coated (BDC) for secure screw fit. The "Take it easy" Bit-Checks have bits with a sleeve which – from its colour and size designation – make it simple to access the right bit quickly.

05057415001	
● ○	889/4/1 K 1 x 1/4"x50
⊕	867/1 TORX® BDC 1 x TX 10x25; 1 x TX 15x25; 1 x TX 20x25; 1 x TX 25x25; 1 x TX 30x25; 1 x TX 40x25

Bit-Check 6 PH Diamond 1



6 Bitorsion bits for long service life, diamond-coated (BDC) for secure screw fit. The "Take it easy" Bit-Checks have bits with a sleeve which – from its colour and size designation – make it simple to access the right bit quickly.

05057404001
851/4 BDC PH 2 x PH 1x50; 3 x PH 2x50; 1 x PH 3x50

Bit-Check 6 PZ Diamond 1



6 Bitorsion bits for long service life, diamond-coated (BDC) for secure screw fit. The "Take it easy" Bit-Checks have bits with a sleeve which – from its colour and size designation – make it simple to access the right bit quickly.

05057402001
855/4 BDC PZ 2 x PZ 1x50; 3 x PZ 2x50; 1 x PZ 3x50

Tip

Chuck-all



The Rapidaptor quick-release chucks hold both 1/4" bits as per DIN ISO 1173-C 6,3 (Wera series 1) and E 6,3 (Wera series 4).

Single-hand



All functions of the quick-release chuck such as the inserting or releasing of bits can be done with just one hand. That is faster, more economic and ergonomic. There are no unnecessary manoeuvres.

Rapid-in and self-lock



The bit can be pushed into the chuck without moving the sleeve. It automatically locks with a secure and wobble-free fit as soon as the bit is applied to the screw.

Rapid-out

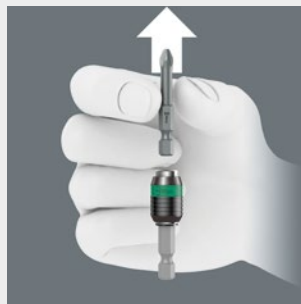

Simply push the sleeve forward to change the bit. The spring mechanism lifts the bit off the magnet and unlocks the tool. The bit can be easily removed. Particularly helpful: even the smallest bits can be removed without any extra tools.

Rapid-spin

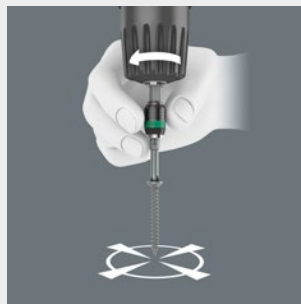

The free-turning sleeve allows screw steadying at the start of the screwdriving process. This makes it easier to apply the tool to the screw and prevents slipping. It can also be used as a short extension for 1/4" applications e.g. in combination with the Wera Zyklop Ratchets.



Bit-Checks / Bit-Safes Universal

For general use

Bit-Safe 61 Universal 1



1 bit holder Rapidaptor with strong permanent magnet and quick-release chuck, 60 bits, Torsion-style (T) design to reduce premature wear, tough (Z), for universal use.

05057122001	
899/4/1 K	1 x 1/4"x50
851/1 TZ PH	3 x PH 1x25; 10 x PH 2x25; 2 x PH 3x25
855/1 TZ PZ	3 x PZ 1x25; 10 x PZ 2x25; 2 x PZ 3x25
867/1 TORX®	2 x TX 10x25; 3 x TX 15x25; 3 x TX 20x25; 3 x TX 25x25; 3 x TX 30x25; 2 x TX 40x25
800/1 TZ	1 x 0,6x4,5x25; 1 x 1,0x5,5x25; 1 x 1,2x6,5x25
840/1 Z	3 x 2,5x25; 3 x 3,0x25; 3 x 4,0x25; 2 x 5,0x25
Hex-Plus	

Bit-Safe 43 Universal 1



1 universal bit holder with stainless steel sleeve, retaining ring, and strong permanent magnet, 42 bits, Torsion-style (T) design to reduce premature wear, tough, for universal use.

05057450001	
899/4/1	1 x 899/4/1 Kx1/4"x50
851/1 Z PH	1 x PH 2x25
851/4 TZ PH	1 x PH1x50; 2 x PH2x50
855/1 Z PZ	2 x PZ 1x25; 5 x PZ 2x25; 2 x PZ 3x25
855/4 TZ PZ	1 x PZ 1x50; 2 x PZ 2x50
867/1 TORX®	3 x TX 10x25; 4 x TX 15x25; 4 x TX 20x25; 4 x TX 25x25; 4 x TX 30x25; 1 x TX 40x25
867/4 Z TORX®	1 x TX 10x50; 1 x TX 15x50; 1 x TX 20x50; 1 x TX 25x50; 1 x TX 30x50; 1 x TX 40x50

Bit-Safe 61 Universal 2



1 universal bit holder with stainless steel sleeve, retaining ring, and strong permanent magnet, 60 bits, tough, for universal use.

05057455001	
899/4/1	1 x 899/4/1 Kx1/4"x50
851/1 Z PH	10 x PH 1x25; 20 x PH 2x25; 5 x PH 3x25
855/1 Z PZ	3 x PZ 2x25
867/1 TORX®	3 x TX 10x25; 5 x TX 15x25; 5 x TX 20x25; 5 x TX 25x25; 2 x TX 30x25; 2 x TX 40x25

Bit-Check 30 Universal 1



1 bit holder Rapidaptor with quick-release chuck, 29 bits, Torsion-style (T) design to reduce premature wear, tough (Z), for universal use, extra-hard (H).

05056440001	
899/4/1 K	1 x 1/4"x50
851/1 TZ PH	2 x PH 1x25; 3 x PH 2x25; 1 x PH 3x25
855/1 TH PZ	2 x PZ 1x25; 3 x PZ 2x25; 1 x PZ 3x25
867/1 TZ	1 x TX 10x25; 1 x TX 15x25; 1 x TX 20x25; TORX®
867/1 Z TORX®	1 x TX 25x25; 1 x TX 30x25; 1 x TX 40x25
BO	1 x TX 10x25; 1 x TX 15x25; 1 x TX 20x25; 1 x TX 25x25; 1 x TX 30x25
800/1 TZ	1 x 1,0x5,5x25
840/1 Z	1 x 3,0x25; 1 x 4,0x25; 1 x 5,0x25; 1 x 6,0x25;
Hex-Plus	1 x 8,0x25

Bit-Check 30 TX Universal 1



1 universal bit holder with stainless steel sleeve, retaining ring, and strong permanent magnet, 29 bits, tough, for universal use.

05057908001	
●○	899/4/1 1 x 899/4/1 Kx1/4"x50
⊕	867/1 TORX® 3 x TX 10x25; 5 x TX 15x25; 8 x TX 20x25; 7 x TX 25x25; 4 x TX 30x25; 2 x TX 40x25

Bit-Check 12 Universal 1



1 bit holder Rapidaptor with quick-release chuck, 11 bits, tough, for universal use, 851/1 A extra-hard, profiled version, 868/1 V with holding function.

05057428001	
●○	888/4/1 K 1 x 1/4"x50
⊕	851/1 A PH 1 x PH 1x25; 2 x PH 2x25; 1 x PH 3x25
⊕	867/1 TORX® 1 x TX 8x25; 1 x TX 20x25; 1 x TX 25x25
○	868/1 V 1 x # 1x25; 2 x # 2x25; 1 x # 3x25

Bit-Check 12 Universal 2



1 magnetic Rapidaptor quick-release bit holder with ringmagnet, 11 bits, tough, for universal use, 851/1 A extra-hard, profiled version, 868/1 V with holding function.

05057429001	
●○	887/4 RR 1 x 1/4"x57
⊕	851/1 A PH 1 x PH 1x25; 2 x PH 2x25; 1 x PH 3x25
●	800/1 Z 1 x 0,8x5,5x25; 1 x 1,0x5,5x25; 1 x 1,2x6,5x25
○	868/1 V 1 x # 1x25; 2 x # 2x25; 1 x # 3x25

Tip



Rapidaptor holder



Rapid bit change without needing any additional tools. One-hand operation with a freely spinning sleeve for simplified guidance of the tool.



Hex-Plus

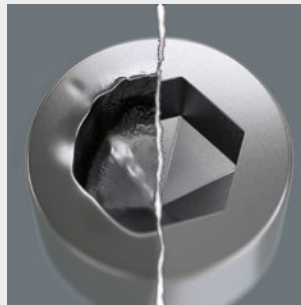

Hexagon screws can endure a problem because the contact surfaces delivering the power from the conventional tool, is transferred to the screw via very small surface areas. The consequence: the screw can become damaged (rounding out). Hex-Plus tools have a greater contact surface that prevents this from happening! Good to know: Hex-Plus tools fit into every standard hexagon socket screw!



Bit-Checks / Bit-Safes Universal

For general use

Bit-Check 10 Universal 1



1 bit holder with strong permanent magnet and quick-release chuck, 9 bits, Torsion-style (T) design to reduce premature wear, tough (Z), for universal use.

05056161001	
● ○	895/4/1 K 1 x 1/4"x52
+	851/1 TZ PH 1 x PH 1x25; 1 x PH 2x25; 1 x PH 3x25
+	855/1 TZ PZ 1 x PZ 1x25; 1 x PZ 2x25; 1 x PZ 3x25
●	800/1 TZ 1 x 0,8x5,5x25; 1 x 1,0x5,5x25; 1 x 1,2x6,5x25

Bit-Check 10 Universal 3



1 bit holder Rapidaptor with quick-release chuck, 9 bits, Torsion-style (T) design to reduce premature wear, tough (Z), for universal use.

05056375001	
● ○	889/4/1 K 1 x 1/4"x50
+	851/1 TZ PH 1 x PH 1x25; 1 x PH 2x25; 1 x PH 3x25
+	855/1 TZ PZ 1 x PZ 1x25; 1 x PZ 2x25; 1 x PZ 3x25
●	800/1 TZ 1 x 0,8x5,5x25; 1 x 1,0x5,5x25; 1 x 1,2x6,5x25

Bit-Check 10 Universal 2



1 bit holder with strong permanent magnet and quick-release chuck, 9 bits, Torsion-style (T) design to reduce premature wear, tough, for universal use, extra-hard (H).

05134200001	
● ○	895/4/1 K 1 x 1/4"x52
+	855/1 TH PZ 1 x PZ 1x25; 2 x PZ 2x25
+	867/1 TORX® 1 x TX 10x25; 1 x TX 15x25; 1 x TX 20x25; 1 x TX 25x25; 1 x TX 30x25; 1 x TX 40x25

Bit-Check 10 Universal 3 SB

05073410001	4013288 099495
● ○	889/4/1 K 1 x 1/4"x50
●	800/1 TZ 1 x 0,8x5,5x25; 1 x 1,0x5,5x25; 1 x 1,2x6,5x25
+	851/1 TZ PH 1 x PH 1x25; 1 x PH 2x25; 1 x PH 3x25
+	855/1 TZ PZ 1 x PZ 1x25; 1 x PZ 2x25; 1 x PZ 3x25



Bit-Check 10 Universal 4



1 Universal bit holder with stainless steel sleeve, retaining ring, and strong permanent magnet, 9 bits, Torsion-style (T) design to reduce premature wear, tough (Z), for universal use.

05056159001	
● ○	899/4/1 1 x 899/4/1 Kx1/4"x50
+	851/1 TZ PH 1 x PH 1x25; 1 x PH 2x25; 1 x PH 3x25
+	855/1 TZ PZ 1 x PZ 1x25; 1 x PZ 2x25; 1 x PZ 3x25
●	800/1 TZ 1 x 0,8x5,5x25; 1 x 1,0x5,5x25; 1 x 1,2x6,5x25

Bit-Check 10 Universal 5 SB



1 Universal bit holder with stainless steel sleeve, retaining ring, and strong permanent magnet, 9 bits, tough, for universal use.

05073416001	899/4/1	●○	1 x 899/4/1 Kx1/4"x50	4013288 128164
	851/1 Z PH	+	1 x PH 2x25	
	855/1 Z PZ	+	1 x PZ 1x25; 1 x PZ 2x25; 1 x PZ 3x25	
	867/1 TORX®	⊖	1 x TX 10x25; 1 x TX 15x25; 1 x TX 20x25; 1 x TX 25x25; 1 x TX 30x25	

Bit-Check 10 PZ Universal 1



1 bit holder with strong permanent magnet and quick-release chuck, 9 bits, Torsion-style (T) design to reduce premature wear, extra-hard (H).

05056163001				
	895/4/1 K	●○	1 x 1/4"x52	
	855/1 TH PZ	+	3 x PZ 1x25; 3 x PZ 2x25; 3 x PZ 3x25	

Bit-Check 10 PZ Universal 2



1 bit holder Rapidaptor with quick-release chuck, 9 bits, Torsion-style (T) design to reduce premature wear, extra-hard (H).

05056376001				
	889/4/1 K	●○	1 x 1/4"x50	
	855/1 TH PZ	+	3 x PZ 1x25; 3 x PZ 2x25; 3 x PZ 3x25	

Tip

Chuck-all



The Rapidaptor quick-release chucks hold both 1/4" bits as per DIN ISO 1173-C 6,3 (Wera series 1) and E 6,3 (Wera series 4).

Single-hand



All functions of the quick-release chuck such as the inserting or releasing of bits can be done with just one hand. That is faster, more economic and ergonomic. There are no unnecessary manoeuvres.

Rapid-in and self-lock

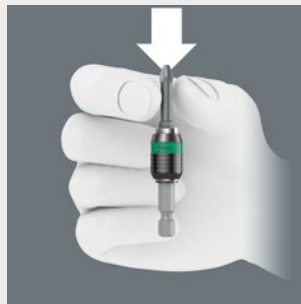

The bit can be pushed into the chuck without moving the sleeve. It automatically locks with a secure and wobble-free fit as soon as the bit is applied to the screw.

Rapid-out



Simply push the sleeve forward to change the bit. The spring mechanism lifts the bit off the magnet and unlocks the tool. The bit can be easily removed. Particularly helpful: even the smallest bits can be removed without any extra tools.

Rapid-spin

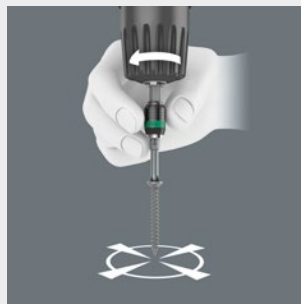

The free-turning sleeve allows screw steadying at the start of the screwdriving process. This makes it easier to apply the tool to the screw and prevents slipping. It can also be used as a short extension for 1/4" applications e.g. in combination with the Wera Zyklop Ratchets.



Bit-Checks / Bit-Safes Universal

For general use

Bit-Check 10 TX Universal 1



1 bit holder with quick-release chuck, 9 bits, Torsion-style (T) design to reduce premature wear, tough (Z), for universal use.

05056164001		
●○	894/4/1 K	1 x 1/4"x51
♻️	867/1 TZ TORX®	1 x TX 8x25; 1 x TX 9x25; 1 x TX 10x25; 1 x TX 15x25; 1 x TX 20x25; 1 x TX 25x25; 1 x TX 27x25; 1 x TX 30x25; 1 x TX 40x25

Bit-Check 7 Universal 1



1 universal bit holder with stainless steel sleeve and strong permanent magnet, 6 bits, tough (Z), for universal use.

05056295001		
●○	893/4/1 K	1 x 1/4"x50
+	851/1 Z PH	1 x PH 1x25; 1 x PH 2x25
+	855/1 Z PZ	1 x PZ 1x25; 1 x PZ 2x25
●	800/1 Z	1 x 1,0x5,5x25; 1 x 1,2x6,5x25

Bit-Check 10 TX Universal 2



1 bit holder Rapidaptor with quick-release chuck, 9 bits, tough, for universal use.

05057115001		
●○	888/4/1 K	1 x 1/4"x50
♻️	867/1 TORX®	1 x TX 6x25; 1 x TX 8x25; 1 x TX 9x25; 1 x TX 10x25; 1 x TX 15x25; 1 x TX 20x25; 1 x TX 25x25; 1 x TX 30x25; 1 x TX 40x25

Bit-Check 7 Universal 1 SB

		4013288
05073406001		036186
●○	893/4/1 K	1 x 1/4"x50
+	851/1 Z PH	1 x PH 1x25; 1 x PH 2x25
+	855/1 Z PZ	1 x PZ 1x25; 1 x PZ 2x25
●	800/1 Z	1 x 1.0x5.5x25; 1 x 1.2x6.5x25



Bit-Check 7 Universal 2



1 bit holder with strong permanent magnet and quick-release chuck, 6 bits, Torsion-style (T) design to reduce premature wear, tough (Z), for universal use.

05056155001	
● ○	893/4/1 K 1 x 1/4"x52
+	851/1 TZ PH 1 x PH 1x25; 1 x PH 2x25
+	855/1 TZ PZ 1 x PZ 1x25; 1 x PZ 2x25
●	800/1 Z 1 x 1,0x5,5x25; 1 x 1,2x6,5x25

Bit-Check 7 PZ Universal 1



1 universal bit holder with stainless steel sleeve and strong permanent magnet, 6 bits, tough (Z), for universal use.

05056296001	
● ○	893/4/1 K 1 x 1/4"x50
+	855/1 Z PZ 2 x PZ 1x25; 3 x PZ 2x25; 1 x PZ 3x25

Bit-Check 7 Universal 3



1 universal bit holder with stainless steel sleeve and strong permanent magnet, 6 bits, tough (Z), for universal use.

05340322001	
● ○	893/4/1 K 1 x 1/4"x50
+	851/1 Z PH 1 x PH 1x25; 1 x PH 2x25
●	800/1 Z 1 x 1,0x5,5x25; 1 x 1,2x6,5x25
○	868/1 Z 1 x # 1x25; 1 x # 2x25

Bit-Check 7 PZ Universal 1 SB

05073536001	4013288	105998
● ○	893/4/1 K	1 x 1/4"x50
+	855/1 Z PZ	2 x PZ 1x25; 3 x PZ 2x25; 1 x PZ 3x25



Bit-Check 7 PZ Universal 2



1 bit holder with strong permanent magnet and quick-release chuck, 6 bits, Torsion-style (T) design to reduce premature wear, extra-hard (H).

05056157001	
● ○	893/4/1 K 1 x 1/4"x52
+	855/1 TH PZ 2 x PZ 1x25; 3 x PZ 2x25; 1 x PZ 3x25

Bit-Check 7 Universal 4



1 universal bit holder with stainless steel sleeve and strong permanent magnet, 6 bits, tough (Z), for universal use.

05135810001	
● ○	893/4/1 K 1 x 1/4"x50
+	851/1 Z PH 1 x PH 2x25
+	855/1 Z PZ 1 x PZ 1x25; 1 x PZ 2x25
+	867/1 TORX® 1 x TX 15x25; 1 x TX 20x25; 1 x TX 25x25



Bit-Checks / Bit-Safes Universal

For general use

Bit-Check 7 TX Universal 1



1 universal bit holder with stainless steel sleeve and strong permanent magnet, 6 bits, tough, for universal use.

05056294001	
●○	893/4/1 K 1 x 1/4"x50
⊕	867/1 TORX® 1 x TX 10x25; 1 x TX 15x25; 1 x TX 20x25; 1 x TX 25x25; 1 x TX 30x25; 1 x TX 40x25

Bit-Check 7 Hex-Plus 1



1 bit holder with strong permanent magnet and quick-release chuck, 6 bits, tough (Z), for universal use.

05056168001	
●○	895/4/1 K 1 x 1/4"x52
○	840/1 Z 1 x 2,0x25; 1 x 2,5x25; 1 x 3,0x25; 1 x 4,0x25; Hex-Plus 1 x 5,0x25; 1 x 6,0x25

Bit-Check 7 TX Universal 1 SB

05073404001		4013288 038111
●○	893/4/1 K 1 x 1/4"x50	
⊕	867/1 TORX® 1 x TX 10x25; 1 x TX 15x25; 1 x TX 20x25; 1 x TX 25x25; 1 x TX 30x25; 1 x TX 40x25	



Bit-Check 7 TiN Universal 1



1 universal bit holder with stainless steel sleeve and strong permanent magnet, 6 bits, TiN coating for the hardness needed e.g. in series screwdriving operations.

05056285001	
●○	893/4/1 K 1 x 1/4"x50
⊕	851/1 TiN PH 1 x PH 1x25; 1 x PH 2x25
⊕	855/1 TiN PZ 1 x PZ 1x25; 1 x PZ 2x25
●	800/1 TiN 1 x 0,8x5,5x25; 1 x 1,2x6,5x25

Bit-Check 7 TX BO Universal 1



1 bit holder with quick-release chuck, 6 bits, tough (Z), for universal use.

05056158001	
●○	894/4/1 K 1 x 1/4"x51
⊕	867/1 Z TORX® 1 x TX 10x25; 1 x TX 15x25; 1 x TX 20x25; BO 1 x TX 25x25; 1 x TX 30x25; 1 x TX 40x25

Bit-Check 7 TiN Universal 1 SB

05073537001		4013288 106001
●○	893/4/1 K 1 x 1/4"x50	
⊕	851/1 TiN PH 1 x PH 1x25; 1 x PH 2x25	
⊕	855/1 TiN PZ 1 x PZ 1x25; 1 x PZ 2x25	
●	800/1 TiN 1 x 0,8x5,5x25; 1 x 1,2x6,5x25	



Bit-Check 7 TiN PZ Universal 1 SB



1 universal bit holder with stainless steel sleeve and strong permanent magnet, 6 bits, TiN coating for the hardness needed e.g. in series screwdriving operations.

05073538001	893/4/1 K	1 x 1/4"x50	4013288 106018
	855/1 TiN PZ	2 x PZ 1x25; 3 x PZ 2x25; 1 x PZ 3x25	

Bit-Check 6 Universal 1



6 bits, Torsion-style (T) design to reduce premature wear, tough (Z), for universal use.

05056474001			
	851/4 TZ PH	1 x PH 1x50; 1 x PH 2x50	
	855/4 TZ PZ	1 x PZ 1x50; 1 x PZ 2x50	
	800/4 Z	1 x 1,0x5,5x50; 1 x 1,2x6,5x50	

Bit-Check 6 Universal 1 SB

05073635001		4013288 155276
	851/4 TZ PH	1 x PH 1x50; 1 x PH 2x50
	855/4 TZ PZ	1 x PZ 1x50; 1 x PZ 2x50
	800/4 Z	1 x 1.0x5.5x50; 1 x 1.2x6.5x50



Tip

TiN-Bits



TiN stands for titanium-nitride. An extremely hard coating to withstand permanent loads such as during continual screwdriving operations in series manufacturing.

Universal holder with quick-release chuck



For a firm, wobble-free connection between holder and bit with quick-release action. Simply push sleeve forward to change bits.

Universal holder with stainless steel sleeve



The retaining ring and the strong permanent magnet ensure a particularly secure fitting of the bit in the holder.



Bit-Checks / Bit-Safes Universal

For general use

Bit-Check 6 Universal 2



6 bits, Torsion-style (T) design to reduce premature wear, tough (Z), for universal use.

05056473001	
+	851/4 TZ PH 1 x PH 2x50
+	855/4 TZ PZ 1 x PZ 1x50; 1 x PZ 2x50
+	867/4 Z TORX® 1 x TX 15x50; 1 x TX 20x50; 1 x TX 25x50

Bit-Check 6 TX Universal 1



6 bits, tough (Z), for universal use.

05056472001	
+	867/4 Z TORX® 1 x TX 10x50; 1 x TX 15x50; 1 x TX 20x50; 1 x TX 25x50; 1 x TX 30x50; 1 x TX 40x50

Bit-Check 6 Universal 2 SB

05073638001		4013288 155245
+	851/4 TZ PH 1 x PH 2x50	
+	855/4 TZ PZ 1 x PZ 1x50; 1 x PZ 2x50	
+	867/4 Z TORX® 1 x TX 15x50; 1 x TX 20x50; 1 x TX 25x50	



Bit-Check 6 TX Universal 1 SB

05073637001		4013288 155252
+	867/4 Z TORX® 1 x TX 10x50; 1 x TX 15x50; 1 x TX 20x50; 1 x TX 25x50; 1 x TX 30x50; 1 x TX 40x50	



Bit-Check 6 Universal 3



6 bits, tough (Z), for universal use, 851/4 A extra-hard, profiled version, 868/1 V with holding function.

05056479001	
+	851/4 A PH 1 x PH 1x50; 1 x PH 2x50
+	867/4 Z TORX® 1 x TX 25x50; 1 x TX 30x50
+	868/4 V 1 x # 1x50; 1 x # 2x50

Bit-Check 6 PZ Universal 1



6 bits, Torsion-style (T) design to reduce premature wear, tough (Z), for universal use.

05056471001	
+	855/4 TZ PZ 2 x PZ 1x50; 3 x PZ 2x50; 1 x PZ 3x50

Bit-Check 6 TX HF 1



6 bits, holding function for TORX® socket screws made according to Acument Intellectual Properties specifications.

05056476001	
867/4 TORX® HF	1 x TX 10x50; 1 x TX 15x50; 1 x TX 20x50; 1 x TX 25x50; 1 x TX 30x50; 1 x TX 40x50

Bit-Check 6 V Universal 1



6 bits, tough (Z), for universal use, with holding function.

05056478001	
868/4 V	1 x # 1x50; 3 x # 2x50; 2 x # 3x50

Tip



The HF profile



In tight assembly or disassembly situations, for example in engine compartments, it is not possible to securely hold the screw with the hand on the screwdriver, and the screw subsequently often gets lost. Lengthy searches or the loss of the screw (with the associated danger that could bring about) are the consequence.

The HF tools developed by Wera are ideal because they feature an optimised geometry of the original TORX® profile. The wedging forces resulting from the surface pressure between the drive tip and the screw profile mean that the screw is securely held on the tool!

V bits:

Holding function for Robertson screws

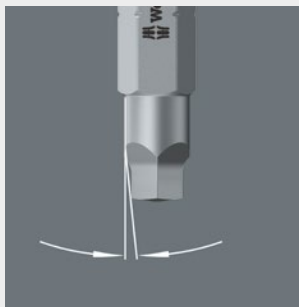

V bits have a conical profile. The clamping forces thus resulting hold Robertson screws securely on the tip of the tool. Ideal for screwdriving at difficult-to-access places.



Bit-Checks Wood

For wood applications

Bit-Safe 61 Wood 1



1 bit holder with strong permanent magnet and quick-release chuck, 60 bits, tough, for universal use.

05057442001	
●○	895/4/1 K 1 x 1/4"x52
+	851/1 Z PH 3 x PH 1x25
+	855/1 Z PZ 10 x PZ 1x25; 20 x PZ 2x25; 5 x PZ 3x25
+	867/1 TORX® 3 x TX 10x25; 5 x TX 15x25; 5 x TX 20x25; 5 x TX 25x25; 2 x TX 30x25; 2 x TX 40x25

Bit-Check 30 Wood 2



1 universal bit holder with stainless steel sleeve, retaining ring, and strong permanent magnet, 29 bits, tough, for universal use.

05057432001	
●○	899/4/1 1 x 899/4/1 Kx1/4"x50
+	851/1 Z PH 1 x PH 2x25
+	855/1 Z PZ 2 x PZ 1x25; 5 x PZ 2x25; 2 x PZ 3x25
+	867/1 TORX® 3 x TX 10x25; 4 x TX 15x25; 4 x TX 20x25; 4 x TX 25x25; 3 x TX 30x25; 1 x TX 40x25

Bit-Check 30 Wood 1



1 magnetic Rapidaptor quick-release bit holder with ringmagnet, 29 bits, Torsion-style (T) design to reduce premature wear, tough, for universal use, extra-hard (H).

05057433001	
●○	887/4 RR 1 x 1/4"x57
+	851/1 TZ PH 2 x PH 2x25; 1 x PH 3x25
+	855/1 TH PZ 3 x PZ 1x25; 6 x PZ 2x25; 2 x PZ 3x25
+	867/1 TZ TORX® 2 x TX 10x25; 2 x TX 15x25; 4 x TX 20x25; 4 x TX 25x25; 2 x TX 30x25; 1 x TX 40x25

Bit-Check 12 Wood 1



1 magnetic Rapidaptor quick-release bit holder with ringmagnet, 11 bits, Torsion-style (T) design to reduce premature wear, tough, for universal use, extra-hard (H).

05057423001	
●○	887/4 RR 1 x 1/4"x57
+	855/1 TH PZ 1 x PZ 1x25; 2 x PZ 2x25; 1 x PZ 3x25
+	851/1 TH PH 1 x PH 2x25
+	867/1 TORX® 1 x TX 10x25; 1 x TX 15x25; 1 x TX 20x25; 1 x TX 25x25; 1 x TX 30x25; 1 x TX 40x25

Bit-Check 12 Wood 2



1 universal bit holder with stainless steel sleeve, retaining ring, and strong permanent magnet, 11 bits, tough, for universal use.

05057422001	
●○	899/4/1 1 x 899/4/1 Kx1/4"x50
⊕	851/1 Z PH 1 x PH 2x25
⊕	855/1 Z PZ 1 x PZ 1x25; 2 x PZ 2x25; 1 x PZ 3x25
⊕	867/1 TORX® 1 x TX 10x25; 1 x TX 15x25; 1 x TX 20x25; 1 x TX 25x25; 1 x TX 30x25; 1 x TX 40x25

Bit-Check 12 Wood 3



1 universal bit holder with stainless steel sleeve and strong permanent magnet, 11 bits, tough, for universal use, 851/1 A extra-hard, profiled version, 868/1 V with holding function.

05057426001	
●○	893/4/1 K 1 x 1/4"x50
⊕	851/1 A PH 1 x PH 1x25; 1 x PH 2x25; 1 x PH 3x25
⊕	867/1 TORX® 1 x TX 10x25; 1 x TX 15x25; 1 x TX 20x25; 1 x TX 25x25; 1 x TX 30x25; 1 x TX 40x25
○	868/1 V 1 x # 2x25; 1 x # 3x25

Bit-Check 12 Wood 4



1 universal bit holder with stainless steel sleeve and strong permanent magnet, 11 bits, extra-hard, profiled version.

05057427001	
●○	893/4/1 K 1 x 1/4"x50
⊕	851/1 A PH 2 x PH 1x25; 6 x PH 2x25; 3 x PH 3x25

Tip

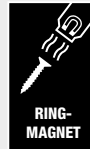

Rapidaptor ring magnet

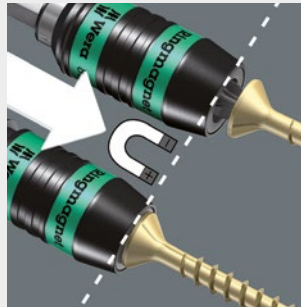

The floating, free-turning sleeve on the Rapidaptor with powerful ring magnet securely holds even large and heavy screws.

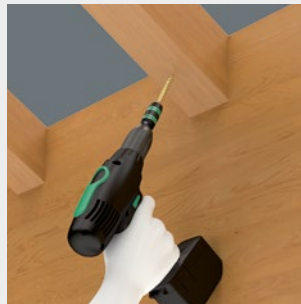

There is no need to hold the screw when applying the tool – something which can be dangerous and painful!

Universal holder with quick-release chuck



For a firm, wobble-free connection between holder and bit with quick-release action. Simply push sleeve forward to change bits.

Universal holder with stainless steel sleeve



The retaining ring and the strong permanent magnet ensure a particularly secure fitting of the bit in the holder.



Bit-Checks Metal

For steel applications

Bit-Check 30 Metal 1



1 universal bit holder with stainless steel sleeve, retaining ring, and strong permanent magnet, 29 bits, tough (Z), for universal use.

05057434001		
● ○	899/4/1	1 x 899/4/1 Kx1/4"x50
+	851/1 Z PH	3 x PH 1x25; 3 x PH 2x25; 2 x PH 3x25
+	855/1 Z PZ	3 x PZ 1x25; 3 x PZ 2x25; 3 x PZ 3x25
+	867/1 TORX®	1 x TX 10x25; 1 x TX 15x25; 1 x TX 20x25; 1 x TX 25x25; 1 x TX 30x25; 1 x TX 40x25
●	800/1 Z	1 x 0,6x4,5x25; 1 x 1,0x5,5x25; 1 x 1,2x6,5x25
○	840/1 Z Hex-Plus	1 x 4,0x25; 1 x 5,0x25; 1 x 6,0x25

Bit-Check 12 Metal 1



1 universal bit holder with stainless steel sleeve, retaining ring, and strong permanent magnet, 11 bits, tough (Z), for universal use.

05057424001		
● ○	899/4/1	1 x 899/4/1 Kx1/4"x50
+	851/1 Z PH	1 x PH 1x25; 1 x PH 2x25
+	855/1 Z PZ	1 x PZ 1x25; 1 x PZ 2x25
+	867/1 TORX®	1 x TX 15x25; 1 x TX 20x25; 1 x TX 25x25; 1 x TX 30x25
○	840/1 Z Hex-Plus	1 x 3,0x25; 1 x 4,0x25; 1 x 5,0x25



Bit Sets for Special Applications

Screwdriving, Drilling, Tapping, Countersinking and Deburring

843 Stepped drill bits, 4-20 mm



Construction: 9 drill steps increasing by 2 mm for material with a max. thickness of 4.5 mm. With edge breaker (sheet metal countersink) at Ø 10 for 1-mm sheet metal

Drive: 1/4" hexagon, suitable for DIN ISO 1173-D 6,3 holders



	 mm
05104672001	75,0

844/7 Tap Bits Set



7 pieces in robust case

1 universal bit holder 888/4/1 K Rapidaptor, nonmagnetic, suitable for power tools and electronic drills; single tap bits with 1/4" drive, suitable for holders with DIN ISO 1173-D 6,3 receiver.





	
05104654001	
	888/4/1 K 1 x 1/4"x50
	844 1 x 3,0x33,0; 1 x 4,0x35,0; 1 x 5,0x36,0; 1 x 6,0x40,0; 1 x 8,0x40,0; 1 x 10,0x40,0

844 Single Tap Bits



Application: For cutting metric threads

Drive: 1/4" hexagon, suitable for DIN ISO 1173-D 6,3 holders

				
	mm	mm	mm	
05104666001	3,0	10,00	33,0	M 3
05104667001	4,0	11,00	35,0	M 4
05104668001	5,0	12,50	36,0	M 5
05104669001	6,0	18,00	40,0	M 6
05104670001	8,0	20,00	40,0	M 8
05104671001	10,0	20,00	40,0	M 10





845 1-flute Countersink Bits



Application: For countersinking and deburring

Design: 1-flute

Drive: 1/4" hexagon, suitable for DIN ISO 1173-D 6,3 holders

				
	mm	mm	mm	
05104660001	6,30	21,00	32,0	M 3
05104661001	8,30	21,00	32,0	M 4
05104662001	10,40	21,00	34,0	M 5
05104663001	12,40	21,00	36,0	M 6
05104664001	16,50	22,00	40,0	M 8
05104665001	20,50	22,00	43,0	M 10



Bit Sets for Special Applications

Screwdriving, Drilling, Tapping, Countersinking and Deburring

845/8 1-flute Countersink Bits Set



8 pieces in robust case

1 Kraftform 816 R Rapidaptor quick release bit holder; 1 universal holder 888/4/1 K Rapidaptor, nonmagnetic, suitable for power tools and electronic drills.

05104655001		
●	816 R	1 x 1/4"x119
●○	888/4/1 K	1 x 1/4"x50
●	845	1 x 6,30x32,0; 1 x 8,30x32,0; 1 x 10,40x34,0; 1 x 12,40x36,0; 1 x 16,50x40,0; 1 x 20,50x43,0

847 HSS Combined Tap Bits



Application: Drilling, tapping, deburring

Design: HSS

Drive: 1/4" hexagon, suitable for DIN ISO 1173-D 6,3 holders

	mm	mm	mm	
05104640001	2,5	12,00	36,0	M 3
05104641001	3,3	12,00	39,0	M 4
05104642001	4,2	12,00	41,0	M 5
05104643001	5,0	12,00	44,0	M 6
05104644001	6,8	12,00	51,0	M 8
05104645001	8,5	12,00	59,0	M 10

846 3-flute Countersink Bit



Application: For deburring, chamfering, countersinking

Design: 3-flute 90° DIN 335-C cutter

Drive: 1/4" hexagon suitable for holders with DIN ISO 1173-D 6,3 receiver

	mm	mm	mm	
05104630001	6,30	20,00	31,0	M 3
05104631001	8,30	20,00	31,0	M 4
05104632001	10,40	20,00	34,0	M 5
05104633001	12,40	20,00	35,0	M 6
05104634001	16,50	20,00	40,0	M 8
05104635001	20,50	20,00	41,0	M 10

846/8 3-flute Countersink Bits Set



8 pieces in robust case

1 Kraftform quick release bitholding screwdriver 816 R

1 universal bit holder 888/4/1 K Rapidaptor suitable for power tools and electronic drills; countersink bits with 1/4" drive suitable for power tools with DIN ISO 1173-D 6,3 receiver.

05104650001		
●	816 R	1 x 1/4"x119
●○	888/4/1 K	1 x 1/4"x50
●	846 HSS	1 x 6,30x31,0; 1 x 8,30x31,0; 1 x 10,40x34,0; 1 x 12,40x35,0; 1 x 16,50x40,0; 1 x 20,50x41,0

847/7 Set Combination Drill Bits Set



7 pieces in robust case

1 Universal bit holder Rapidaptor 888/4/1 K with quick-release chuck suitable for power tools and electronic drills; combination drill bits, 1/4" drive, suitable for power tools with DIN ISO 1173-D 6,3 receiver.

05104651001		
	888/4/1 K	1 x 1/4"x50
	847 HSS	1 x 2,5x36,0; 1 x 3,3x39,0; 1 x 4,2x41,0; 1 x 5,0x44,0; 1 x 6,8x51,0; 1 x 8,5x59,0

848 HSS Metal Twist Drill Bits



Application: For precise drilling in metal

Construction: HSS

Drive: 1/4" hexagon, suitable for DIN ISO 1173-D 6,3 holders

	mm	mm	mm
05104610001	3,0	16,00	38,0
05104611001	3,1	18,00	40,0
05104612001	3,3	18,00	40,0
05104613001	4,0	20,00	44,0
05104614001	4,1	20,00	44,0
05104615001	4,2	20,00	45,0
05104616001	5,0	26,00	50,0
05104617001	5,1	26,00	50,0
05104618001	6,0	26,00	50,0
05104619001	6,8	30,00	50,0
05104620001	8,0	32,00	51,0
05104621001	8,5	33,00	53,0
05104622001	10,0	38,00	54,0

849 HSS Twist Wood Drill Bits



Application: For point-precision, splinter-free drilling in soft woods, hard woods, and laminated panel material

Design: HSS

Drive: 1/4" hexagon, suitable for DIN ISO 1173-D 6,3 holders

	mm	mm	mm
05104600001	3,0	32,00	70,0
05104601001	4,0	32,00	74,0
05104602001	5,0	43,00	85,0
05104603001	6,0	45,00	95,0
05104604001	8,0	60,00	110,0
05104605001	10,0	70,00	120,0

848/851/867/19 Metal Twist Drill Bits and Bits Set



19 pieces in robust belt pouch

1 Universal bit holder Rapidaptor 888/4/1 K suitable for power tools and electronic drills; metal twist Drill Bits and Bits with 1/4" drive, suitable for power tools with DIN ISO 1173-D 6,3 receiver.

05104652001		
	888/4/1 K	1 x 1/4"x50
	851/1 TZ PH	2 x PH 1x25; 3 x PH 2x25; 1 x PH 3x25
	848 HSS	1 x 3,0x38,0; 1 x 4,0x44,0; 1 x 4,2x45,0; 1 x 5,0x50,0; 1 x 6,0x50,0; 1 x 8,0x51,0
	867/1 TORX®	1 x TX 10x25; 1 x TX 15x25; 1 x TX 20x25; 1 x TX 25x25; 1 x TX 30x25; 1 x TX 40x25





849/855/867/18 Wood Twist Drill Bits and Bits Set



18 pieces in robust belt pouch

1 Universal bit holder Rapidaptor 889/4/1 K suitable for power tools and electronic drills; wood Twist Drill Bit and Bits, 1/4" drive, suitable for power tools with DIN ISO 1173-D 6,3 receiver.

05104653001	
● ○	889/4/1 K 1 x 1/4"x50
⊗	849 HSS 1 x 3,0x70,0; 1 x 4,0x74,0; 1 x 5,0x85,0; 1 x 6,0x95,0; 1 x 8,0x110,0
⊕	855/1 TH PZ 2 x PZ 1x25; 3 x PZ 2x25; 1 x PZ 3x25
⊗	867/1 TORX® 1 x TX 10x25; 1 x TX 15x25; 1 x TX 20x25; 1 x TX 25x25; 1 x TX 30x25; 1 x TX 40x25

Bit-Check 10 Drywall 1



1 bit holder 896/4/1 out of Aluminium with adjustable depth stop suitable for power tools and electronic drills; screw depth can be infinitely adjusted and enables flush alignment of sunken screws; 9 drywall construction bits with modified drive shaft; length 25mm

05136011001	
● ○	896/4/1 1 x 1/4"x50
⊕	851/1 RZ PH 9 x PH 2x25

Tip

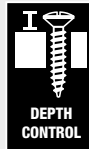

Bit holder with adjustable depth stop



The screw installation depth can be infinitely adjusted and allows the desired degree of countersinking of the screws.





Torque Tools



Series 7400
Adjustable Torque Screwdrivers

470



Series 7400
Pre-set, Adjustable Torque
Screwdrivers

478



Series Torque-indicators

484



Series Click-Torque Wrenches

490



Series Insert Tools

502



Torque Tools

Wera's torque tools offer torque-controlled screw tightening so as to avoid damage to the screw or workpiece and to ensure the integrity of the screw connection. This makes work-intensive drilling-out of screws and unproductive downtimes a thing of the past. It is also important whenever repeat accuracy is required.

They come with an ergonomic Kraftform handle and have a distinctly audible and perceptible click signal whenever the required torque value is reached.

No time-consuming blade changes; instead of special blades, conventional bits conforming to C 6,3 and E 6,3 or even ¼" sockets can be used.



Adjustable torque screwdrivers

They can be adjusted by hand to the corresponding scale value. Also available in ESD version (also with take-up for HIOS/Halfmoon bits) and with Kraftform Micro handle. See page 470.

For the insulated VDE-version see page 114.

Pre-set, adjustable torque screwdrivers

Pre-set torque, adjustable within a defined range. Also available in ESD version (also for HIOS/Halfmoon bits) and with Kraftform Micro handle.

See page 478.



Torque-indicators

Suitable for applications requiring a non-adjustable i.e. a tamperproof torque blade assembly.
See page 484.



Series Click-Torque wrenches

Suitable for controlled tightening using sockets.
See page 490.



Adjustable Torque Screwdrivers

Wera's adjustable torque screwdrivers allow variable torque settings with maximum precision and ensure that the user gets the very best results in the familiar Wera design with superior ergonomics.



Simple setting of the required torque by hand.



Easy-to-read scale value.



Measurement accuracy is $\pm 6\%$ in accordance with the standard DIN EN ISO 6789. Distinctly audible and noticeable excess-load signal when the pre-set torque is reached.

All Wera torque screwdrivers manufactured according to DIN EN ISO 6789 are supplied with a calibration certificate. Our workshop offers a comprehensive service for all Wera torque tools. Please contact us with any queries regarding service, recalibration or repair on +49 (0)202 40 45 145; Fax: +49 (0)202 40 45 158 or per E-Mail at: torqueservice@wera.de.



Rapidaptor technology makes the tool adaptable since bits and sockets can be exchanged rapidly.

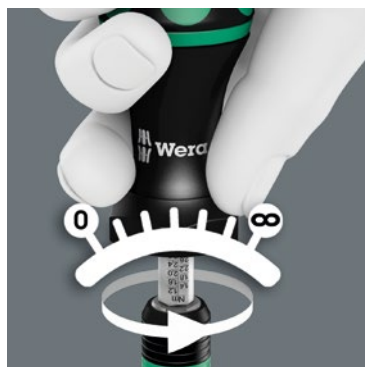

Unlimited torque for loosening seized screws.



Multi-component Kraftform handle with hard and soft zones for fast working speeds and protecting the palm of the hand.

For the insulated VDE-version see page 114.



Series 7400 Kraftform Torque Screwdrivers

Variable torque adjustment models

Series 7400 Kraftform adjustable torque screwdrivers (0.1-3.0 Nm) with Rapidaptor quick-release chuck



Application: Suitable for 1/4" DIN ISO 1173-C 6,3 and E 6,3 hexagon insert bits and Wera Series 1 and 4

Design: Rapidaptor rapid-in, rapid-out, rapid-spin, chuck-all and single-hand technology

Accuracy: ±6 % (DIN EN ISO 6789). Numerical torque value scale, audible excess-load signal

Handle: Kraftform with non-roll feature, multi-component

	Art.No.	mm	Nm	Nm	mm	mm
05074770001 ¹⁾	7430	89	1/4"	0,10-0,34 0,015	142	5 7/16"
05074772001 ¹⁾	7431	89	1/4"	0,30-1,00 0,05	142	5 7/16"
05074774001 ¹⁾	7432	89	1/4"	0,90-1,50 0,05	142	5 7/16"
05074700001	7440	105	1/4"	0,3-1,2 0,05	155	6"
05074701001	7441	105	1/4"	1,2-3,0 0,10	155	6"

¹⁾ With attachable magnifying glass, dramatically improving visibility.

Series 7400 Kraftform pistol grip, adjustable torque screwdrivers (3.0-8.8 Nm) with Rapidaptor quick-release chuck



Application: Suitable for 1/4" DIN ISO 1173-C 6,3 and E 6,3 hexagon insert bits and Wera Series 1 and 4

Design: Rapidaptor rapid-in, rapid-out, rapid-spin, chuck-all and single-hand technology

Accuracy: ±6 % (DIN EN ISO 6789). Numerical torque value scale, audible excess-load signal

Handle: Kraftform pistol grip, multi-component

	Art.No.	Nm	Nm	mm	mm	mm
05074702001	7442	1/4"	3,0-6,0 0,25	150	100	4"
05074705001	7443	1/4"	4,0-8,8 0,40	150	100	4"



Rapidaptor

Rapid-in and self-lock



The bit can be pushed into the adaptor without moving the sleeve. The lock is activated automatically as soon as the bit is applied to the screw. Bits are held securely and wobble-free.

Rapid-out

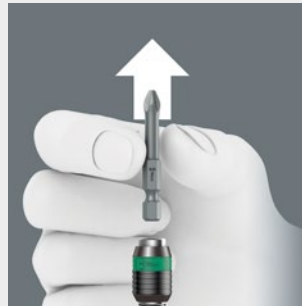

Simply push the sleeve forward to change the bit. The spring mechanism lifts the bit off the magnet and unlocks the tool. The bit can be easily removed. The rapid-out function makes it easy to remove even the smallest bits without extra tools.

Chuck-all

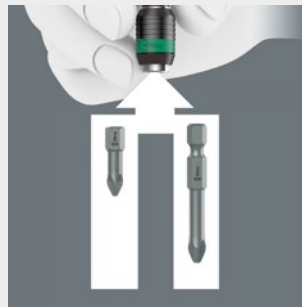

The Rapidaptor quick-release chucks hold 1/4" DIN ISO 1173-C 6,3 and E 6,3 as well as Wera series 1 and 4 bits.

Single-hand function



Every function of the Rapidaptor quick-release chuck, such as inserting or releasing bits, can be carried out with one hand. This is faster, more economical and more ergonomic. There are no unnecessary manoeuvres.

Attachable magnifying glass



Articles 7430, 7431, 7432, 7430 ESD, 7431 ESD, 7432 ESD, 7435 ESD, 7436 ESD, 1430 ESD and 1431 ESD all come with a magnifying glass. This can be easily attached on to the scale, dramatically improving visibility.

Series 7400 Kraftform ESD adjustable torque screwdrivers (0.1-3.0 Nm) with Rapidaptor quick-release chuck



Application: Suitable for 1/4" DIN ISO 1173-C 6,3 and E 6,3 hexagon insert bits and Wera Series 1 and 4

Design: Rapidaptor rapid-in, rapid-out, rapid-spin, chuck-all and single-hand technology, non-magnetic

Accuracy: ±6 % (DIN EN ISO 6789). Numerical torque value scale, audible excess-load signal

Handle: Kraftform with non-roll feature, multi-component

	Art.No.	mm	mm	Nm	Nm	mm	mm
05074780001 ¹⁾	7430 ESD	89	1/4"	0,10-0,34	0,015	142	5 7/16"
05074782001 ¹⁾	7431 ESD	89	1/4"	0,30-1,00	0,05	142	5 7/16"
05074784001 ¹⁾	7432 ESD	89	1/4"	0,90-1,50	0,05	142	5 7/16"
05074730001	7440 ESD	105	1/4"	0,3-1,2	0,05	155	6"
05074731001	7441 ESD	105	1/4"	1,2-3,0	0,10	155	6"

¹⁾ With attachable magnifying glass, dramatically improving visibility.

Series 7400 Kraftform Torque Screwdrivers

Variable torque adjustment models

Series 7400 Kraftform pistol grip, adjustable torque screwdrivers (25.0-55.0 in. lbs.) with Rapidaptor quick-release chuck



- Application:** Suitable for 1/4" DIN ISO 1173-C 6,3 and E 6,3 hexagon insert bits and Wera Series 1 and 4
- Design:** Rapidaptor rapid-in, rapid-out, rapid-spin, chuck-all and single-hand technology
- Accuracy:** ±6 % (DIN EN ISO 6789). Numerical torque value scale. Audible excess-load signal
- Handle:** Kraftform pistol grip, multi-component

	Art.No.						
		in. lbs.	in. lbs.	mm	mm		
05074712001	7447	1/4"	25,0-55,0	2,5	150	100	4"

Series 7400 Kraftform adjustable torque screwdrivers (2.5-29.0 in. lbs.) with Rapidaptor quick-release chuck



- Application:** Suitable for 1/4" DIN ISO 1173-C 6,3 and E 6,3 hexagon insert bits and Wera Series 1 and 4
- Design:** Rapidaptor rapid-in, rapid-out, rapid-spin, chuck-all and single-hand technology
- Accuracy:** ±6 % (DIN EN ISO 6789). Numerical torque value scale. Audible excess-load signal
- Handle:** Kraftform with non-roll feature, multi-component

	Art.No.				
		in. lbs.	in. lbs.	mm	
05074710001	7445	1/4"	2,5-11,5	0,5	155
05074711001	7446	1/4"	11,0-29,0	1,0	155

Series 7400 Kraftform ESD adjustable torque screwdrivers (2.5-29.0 in.lbs.) with Rapidaptor quick-release chuck



- Application:** Suitable for 1/4" DIN ISO 1173-C 6,3 and E 6,3 hexagon insert bits and Wera Series 1 and 4
- Design:** Rapidaptor rapid-in, rapid-out, rapid-spin, chuck-all and single-hand technology, non-magnetic
- Accuracy:** ±6 % (DIN EN ISO 6789). Numerical torque value scale. Audible excess-load signal
- Handle:** Kraftform with non-roll feature, multi-component

	Art.No.				
		in. lbs.	in. lbs.	mm	
05074733001	7445 ESD	1/4"	2,5-11,5	0,5	155
05074734001	7446 ESD	1/4"	11,0-29,0	1,0	155

Series 7400 Kraftform ESD adjustable torque screwdrivers (0.1-1.0 Nm)



Application: Suitable for bits with 4 mm Halfmoon drive (and Wera Serie 9) and 4 mm HIOS drive (and Wera Series 21)

Design: With quick-release chuck for rapid bit change

Accuracy: ±6 % (DIN EN ISO 6789)

Handle: Kraftform with non-roll feature, multi-component

	Art.No.	mm	Nm	Nm	mm	mm
05074786001 ¹⁾	7435 ESD	89	0,10-0,34	0,015	142	5 7/16"
05074788001 ¹⁾	7436 ESD	89	0,30-1,00	0,05	142	5 7/16"

¹⁾ With attachable magnifying glass, dramatically improving visibility.

1430 Kraftform Micro ESD adjustable torque screwdrivers (0.02-0.11 Nm) with quick-release chuck

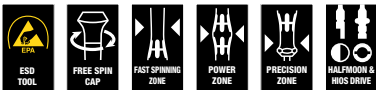

Application: Suitable for bits with 4 mm Halfmoon drive (and Wera Serie 9) and 4 mm HIOS drive (and Wera Series 21)

Design: With quick-release chuck for rapid bit change

Accuracy: ± 10%

Handle: Kraftform Micro with non-roll feature and rotating cap, multi-component

	Art.No.	Nm	Nm	mm	mm
05074802001 ¹⁾	1430 ESD	0,02-0,06	0,0025	141	5 7/16"
05074804001 ¹⁾	1431 ESD	0,05-0,11	0,005	141	5 7/16"

¹⁾ With attachable magnifying glass, dramatically improving visibility.

Tip

Attachable magnifying glass



Articles 7435 ESD, 7436 ESD, 1430 ESD and 1431 ESD, all come with a magnifying glass. This can be easily attached on to the scale, dramatically improving visibility.

Why does Wera manufacture adjustable Kraftform torque screwdrivers?



Many screws – particularly in assembly and maintenance applications – have to be tightened with controlled torque to ensure the dependability of the screw connection and/or to avoid damage to the screw or work piece. Wera's adjustable torque screwdrivers are the ideal tool for this. They feature a torque range of 0.3 Nm

to 8.8 Nm, two different handles, measurement accuracy of ± 6 % and Rapidaptor technology for rapid bit change.

For Halfmoon and HIOS Bits

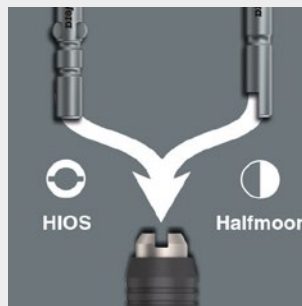

The adjustable torque screwdrivers 7435 ESD, 7436 ESD, 1430 ESD and 1431 ESD feature a combination bitholder for both bits with Halfmoon and bits with HIOS drive.



Series 7400 Kraftform Torque Screwdrivers

Variable torque adjustment models

7440/41 Kraftform torque screwdriver set 0.3-3.0 Nm

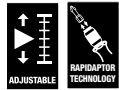

05074738001		
●	7400	1 x 7440x1/4"x0,3-1,2; 1 x 7441x1/4"x1,2-3,0
⊕	867/1 TZ TORX®	1 x TX 6x25; 1 x TX 7x25; 1 x TX 8x25; 1 x TX 9x25; 1 x TX 10x25; 1 x TX 15x25; 1 x TX 20x25; 1 x TX 25x25; 1 x TX 30x25
⊕	867/1 Z IP TORX PLUS®	1 x 6 IPx25; 1 x 7 IPx25; 1 x 8 IPx25; 1 x 9 IPx25; 1 x 10 IPx25; 1 x 15 IPx25; 1 x 20 IPx25; 1 x 25 IPx25; 1 x 30 IPx25
○	840/1 Z Hex-Plus	1 x 2,0x25; 1 x 2,5x25; 1 x 3,0x25; 1 x 4,0x25; 1 x 5,0x25; 1 x 6,0x25

7440/41/42 Kraftform torque screwdriver set 0.3-6.0 Nm

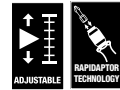

05074739001		
●	7400	1 x 7440x1/4"x0,3-1,2; 1 x 7441x1/4"x1,2-3,0
●	7400 Pistole	1 x 7442x3,0-6,0
⊕	867/1 TZ TORX®	1 x TX 6x25; 1 x TX 7x25; 1 x TX 8x25; 1 x TX 9x25; 1 x TX 10x25; 1 x TX 15x25; 1 x TX 20x25; 1 x TX 25x25; 1 x TX 30x25
⊕	867/1 Z IP TORX PLUS®	1 x 6 IPx25; 1 x 7 IPx25; 1 x 8 IPx25; 1 x 9 IPx25; 1 x 10 IPx25; 1 x 15 IPx25; 1 x 20 IPx25; 1 x 25 IPx25; 1 x 30 IPx25
○	840/1 Z Hex-Plus	1 x 2,0x25; 1 x 2,5x25; 1 x 3,0x25; 1 x 4,0x25; 1 x 5,0x25; 1 x 6,0x25

7445/46/47 Kraftform torque screwdriver set 2.5-55.0 in.lbs.

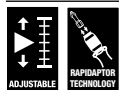

05350451001		
●	7400 inch	1 x 7445x2,5-11,5; 1 x 7446x11,0-29,0
●	7400 Pistole inch	1 x 7447x25,0-55,0
⊕	867/1 TZ TORX®	1 x TX 6x25; 1 x TX 7x25; 1 x TX 8x25; 1 x TX 9x25; 1 x TX 10x25; 1 x TX 15x25; 1 x TX 20x25; 1 x TX 25x25; 1 x TX 30x25
⊕	867/1 Z IP TORX PLUS®	1 x 6 IPx25; 1 x 7 IPx25; 1 x 8 IPx25; 1 x 9 IPx25; 1 x 10 IPx25; 1 x 15 IPx25; 1 x 20 IPx25; 1 x 25 IPx25; 1 x 30 IPx25
○	840/1 Z Hex-Plus	1 x 2,0x25; 1 x 2,5x25; 1 x 3,0x25; 1 x 4,0x25; 1 x 5,0x25; 1 x 6,0x25

7443/61/9 Assembly set for tyre pressure control systems

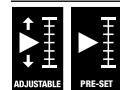

05074745001		
●	7400 vor	1 x 7461x3,3 ¹⁾
●	7400 Pistole	1 x 7443x4,0-8,8
⊕	300 TX	1 x TX 10x1,4
⊕	870/1	1 x 1/4"x25
●	790 A/50	1 x 11,0x50,0; 1 x 12,0x50,0
⊕	867/4 TORX® HF	1 x TX 15x50; 1 x TX 20x50
○	327	1 x 32

¹⁾ Other pre-set values within the adjustable range <3.3 Nm can be delivered on request

7443/12 Assembly set for tyre pressure control systems

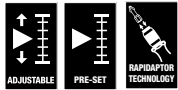

Suitable for all leading system suppliers such as Alligator, Beru, CUB, Herth & Buss, Schrader, VDO/Conti.

1 adjustable torque screwdriver, pistol handle, 4.0-8.8 Nm; 1 pre-set torque screwdriver 3.3 Nm; 1 pre-set torque screwdriver 1.4 Nm TX 10; 1 pre-set torque screwdriver 1.25 Nm TX 10; 1 valve dolly; 1 bit 867/4 HF TX 15 x 50 mm, with holding function for TORX® screws; 1 bit 867/4 HF TX 20 x 50 mm, with holding function for TORX® screws; 1 socket 790 A/50 SW 11.0 x 50 mm; 1 socket 790 A/50 SW 12.0 x 50 mm; 1 adaptor 870/1; 1/4" hexagon to 1/4" square; 1 valve insertion tool, pre-set torque: 0.25 Nm; 1 valve insertion tool, pre-set torque: 0.45 Nm.

Practically arranged in a robust foam insert.

05074746001		
●	7400 Pistole	1 x 7443x4,0-8,8
●	7400 vor	1 x 7461x3,3 ¹⁾
⊛	300 TX	1 x TX 10x1,25; 1 x TX 10x1,4
●	790 A/50	1 x 11,0x50,0; 1 x 12,0x50,0
⊛	867/4 TORX® HF	1 x TX 15x50; 1 x TX 20x50
⊙	870/1	1 x 1/4"x25
●	300 V	1 x 0,25; 1 x 0,45
○	327	1 x 32

¹⁾ Other pre-set values within the adjustable range < 3.3 Nm can be delivered on request

Tip

Assembly sets for tyre control systems



Suitable for all leading system suppliers like Alligator, Beru, CUB, Herth & Buss, Schrader, VDO/Conti.



Including adjustable and pre-set torque tools, colour-coded valve insertion tool and valve dolly. The robust foam insert provides for a practical arrangement system.



Pre-set, adjustable Torque Screwdrivers

These tools are ideal for all applications where a constant, identical torque is required and where a high degree of repeat accuracy is needed. The torque value can be adjusted within the measuring range.

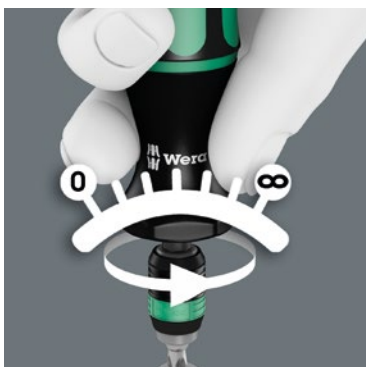

Unlimited torque for loosening seized screws.



Distinctly audible and noticeable excess-load signal when the pre-set torque is reached.



Rapidaptor technology makes the tool adaptable since bits and sockets can be exchanged rapidly.



Multi-component Kraftform handle with hard and soft zones for fast working speeds and protecting the palm of the hand.

All Wera torque screwdrivers manufactured according to DIN EN ISO 6789 are supplied with a calibration certificate. Our workshop offers a comprehensive service for all Wera torque tools. Please contact us with any queries regarding service, recalibration or repair on +49 (0)202 40 45 145; Fax: +49 (0)202 40 45 158 or per E-Mail at: torqueservice@wera.de.



Series 7400 Kraftform Torque Screwdrivers

Pre-set, adjustable torque models

Serie 7400 Kraftform pre-set adjustable torque screwdrivers (0.1-3.0 Nm) with Rapidaptor quick-release chuck



Application: Suitable for 1/4" DIN ISO 1173-C 6,3 and E 6,3 hexagon insert bits and Wera Series 1 and 4

Design: Rapidaptor rapid-in, rapid-out, rapid-spin, chuck-all and single-hand technology

Pre-set torque: 0.1 Nm, 0.3 Nm, 0.9 Nm, 1.2 Nm

Accuracy: ± 6% (DIN EN ISO 6789)

Handle: Kraftform with non-roll feature, multi-component

	Art.No.	mm	mm	Nm	Nm	mm	mm
05074790001	7450	89	1/4"	0,1	0,1-0,34	133	5 1/4"
05074790010 ¹⁾	7450	89	1/4"	0,1	0,1-0,34	133	5 1/4"
05074792001	7451	89	1/4"	0,3	0,3-1,0	133	5 1/4"
05074792010 ¹⁾	7451	89	1/4"	0,3	0,3-1,0	133	5 1/4"
05074794001	7452	89	1/4"	0,9	0,9-1,5	133	5 1/4"
05074794010 ¹⁾	7452	89	1/4"	0,9	0,9-1,5	133	5 1/4"
05074715001	7460	105	1/4"	0,3	0,3-1,2	155	6"
05074715010 ¹⁾	7460	105	1/4"	0,3	0,3-1,2	155	6"
05074716001	7461	105	1/4"	1,2	1,2-3,0	155	6"
05074716010 ¹⁾	7461	105	1/4"	1,2	1,2-3,0	155	6"

¹⁾ Other pre-set values within the adjustable range can be delivered on request

Series 7400 Kraftform pistol grip, pre-set adjustable torque screwdrivers (3.0-8.8 Nm) with Rapidaptor quick-release chuck



Application: Suitable for 1/4" DIN ISO 1173-C 6,3 and E 6,3 hexagon insert bits and Wera Series 1 and 4

Design: Rapidaptor rapid-in, rapid-out, rapid-spin, chuck-all and single-hand technology

Pre-set torque: 3.0 Nm, 4.0 Nm

Accuracy: ± 6% (DIN EN ISO 6789)

Handle: Kraftform pistol grip, multi-component

	Art.No.	mm	Nm	Nm	mm	mm	mm	mm
05074717001	7462	1/4"	3,0	3,0-6,0	150	100	6"	4"
05074717010 ¹⁾	7462	1/4"	3,0	3,0-6,0	150	100	6"	4"
05074728001	7463	1/4"	4,0	4,0-8,8	150	100	6"	4"
05074728010 ¹⁾	7463	1/4"	4,0	4,0-8,8	150	100	6"	4"

¹⁾ Other pre-set values within the adjustable range can be delivered on request

Serie 7400 Kraftform ESD pre-set adjustable torque screwdrivers (0.1-1.2 Nm) with Rapidaptor quick-release chuck



- Application:** Suitable for 1/4" DIN ISO 1173-C 6,3 and E 6,3 hexagon insert bits and Wera Series 1 and 4
- Design:** Rapidaptor rapid-in, rapid-out, rapid-spin, chuck-all and single-hand technology
- Pre-set torque:** 0.1 Nm, 0.3 Nm, 0.9 Nm, 1.2 Nm
- Accuracy:** ± 6% (DIN EN ISO 6789)
- Handle:** Kraftform with non-roll feature, multi-component

	Art.No.	mm		Nm		mm	mm
05074820001	7450 ESD	89	1/4"	0,1	0,1-0,34	133	5 1/4"
05074820010 ¹⁾	7450 ESD	89	1/4"	0,1	0,1-0,34	133	5 1/4"
05074822001	7451 ESD	89	1/4"	0,3	0,3-1,0	133	5 1/4"
05074822010 ¹⁾	7451 ESD	89	1/4"	0,3	0,3-1,0	133	5 1/4"
05074824001	7452 ESD	89	1/4"	0,9	0,9-1,5	133	5 1/4"
05074824010 ¹⁾	7452 ESD	89	1/4"	0,9	0,9-1,5	133	5 1/4"
05074840001	7460 ESD	105	1/4"	0,3	0,3-1,2	155	6"
05074840010 ¹⁾	7460 ESD	105	1/4"	0,3	0,3-1,2	155	6"
05074842001	7461 ESD	105	1/4"	1,2	1,2-3,0	155	6"
05074842010 ¹⁾	7461 ESD	105	1/4"	1,2	1,2-3,0	155	6"

¹⁾ Other pre-set values within the adjustable range can be delivered on request

Tip

Why does Wera manufacture pre-set, adjustable Kraftform torque screwdrivers?



These torque screwdrivers are supplied with a fixed pre-set torque value. This is ideal for all applications that require constant, identical torque. They feature a pre-set torque range of 0.3 Nm to 4.0 Nm (adjustable between 0.3 Nm – 8.8 Nm), two different handles, measurement accuracy of ± 6 % and Rapidaptor chuck technology for rapid bit change.

Customized pre-setting

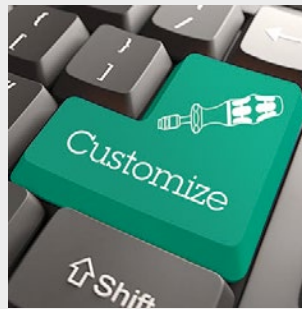

The pre-set torque screwdrivers of the Kraftform 7400 series can be individually pre-set within the specified adjustable range.







Series 7400 Kraftform Torque Screwdrivers

Pre-set, adjustable torque models

Series 7400 Kraftform pre-set adjustable torque screwdrivers (2.5-29.0 in. lbs.) with Rapidaptor quick-release chuck



- Application:** Suitable for 1/4" DIN ISO 1173-C 6,3 and E 6,3 hexagon insert bits and Wera Series 1 and 4
- Design:** Rapidaptor rapid-in, rapid-out, rapid-spin, chuck-all and single-hand technology
- Pre-set torque:** 2.5 in.lbs., 11.0 in.lbs.
- Accuracy:** ±6 % (DIN EN ISO 6789)
- Handle:** Kraftform with non-roll feature, multi-component







	Art.No.					
		in. lbs.	in. lbs.	mm		
05074720001	7465	1/4"	2,5	2,5-11,5	155	6"
05074720010 ¹⁾	7465	1/4"	2,5	2,5-11,5	155	6"
05074722001	7466	1/4"	11,0	11,0-29,0	155	6"
05074722010 ¹⁾	7466	1/4"	11,0	11,0-29,0	155	6"

¹⁾ Other pre-set values within the adjustable range can be delivered on request

Series 7400 Kraftform pistol grip, pre-set adjustable torque screwdriver (25.0-55.0 in. lbs.) with Rapidaptor quick-release chuck



- Application:** Suitable for 1/4" DIN ISO 1173-C 6,3 and E 6,3 hexagon insert bits and Wera Series 1 and 4
- Design:** Rapidaptor rapid-in, rapid-out, rapid-spin, chuck-all and single-hand technology
- Pre-set torque:** 25.0 in. lbs.
- Accuracy:** ±6 % (DIN EN ISO 6789)
- Handle:** Kraftform pistol grip, multi-component

	Art.No.							
		in. lbs.	in. lbs.	mm	mm			
05074721001	7467	1/4"	25,0	25,0-55,0	150	100	6"	4"
05074721010 ¹⁾	7467	1/4"	25,0	25,0-55,0	150	100	6"	4"

¹⁾ Other pre-set values within the adjustable range can be delivered on request

Serie 7400 Kraffform pre-set adjustable torque screwdrivers (0.1-1.0 Nm) with quick-release chuck



- Application:** Suitable for bits with 4 mm Halfmoon drive (and Wera Serie 9) and 4 mm HIOS drive (and Wera Series 21)
- Design:** With quick-release chuck for rapid bit change
- Pre-set torque:** 0.1 Nm, 0.3 Nm
- Accuracy:** ± 6% (DIN EN ISO 6789)
- Handle:** Kraffform with non-roll feature, multi-component

	Art.No.	mm	Nm	Nm	mm	mm
05074826001	7455 ESD	89	0,015	0,1-0,34	138	5 1/4"
05074826010 ¹⁾	7455 ESD	89	0,015	0,1-0,34	138	5 1/4"
05074828001	7456 ESD	89	0,035	0,3-1,0	138	5 1/4"
05074828010 ¹⁾	7456 ESD	89	0,035	0,3-1,0	138	5 1/4"

¹⁾ Other pre-set values within the adjustable range can be delivered on request

1460 Kraffform Micro ESD pre-set adjustable torque screwdrivers (0.02-0.11 Nm) with quick-release chuck



- Application:** Suitable for bits with 4 mm Halfmoon drive (and Wera Serie 9) and 4 mm HIOS drive (and Wera Series 21)
- Design:** With quick-release chuck for rapid bit change
- Pre-set torque:** 0.035 Nm, 0.05 Nm
- Accuracy:** ± 10%
- Handle:** Kraffform Micro with non-roll feature and rotating cap, multi-component

	Art.No.	Nm	Nm	mm	mm
05074800001	1460 ESD	0,035	0,02-0,06	131	5 1/4"
05074800010 ¹⁾	1460 ESD	0,035	0,02-0,06	131	5 1/4"
05074810001	1461 ESD	0,050	0,05-0,11	131	5 1/4"
05074810010 ¹⁾	1461 ESD	0,050	0,05-0,11	131	5 1/4"

¹⁾ Other pre-set values within the adjustable range can be delivered on request

Tip



ESD-safe tools



The requirements for ESD-safe screwdrivers are specified in the European standard DIN EN 61340-5-1. This standard also includes a handle that has to be out of a defined conductive material. The Wera products in the ESD series satisfy these standards and the even more stringent requirements demanded by some technology companies.

For Halfmoon and HIOS Bits

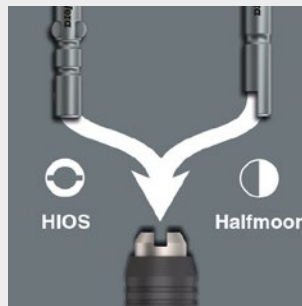

The adjustable torque screwdrivers 7455 ESD, 7456 ESD, 1460 ESD and 1461 ESD feature a combination bitholder for both bits with Halfmoon and bits with HIOS drive.

Customized pre-setting

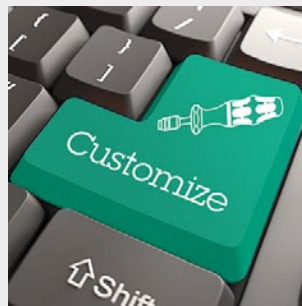

The pre-set torque screwdrivers of the Kraffform 7400 series can be individually pre-set within the specified adjustable range.



Torque-indicators

Wera torque-indicators have been factory pre-set to values recommended by leading carbide tool manufacturers. These tightening values relate specifically to the size of the TORX®, TORX PLUS® or hexagon socket screw. Torque indicators ensure safe and easy loosening of screw connections. Precision : $\pm 10\%$



Torque blade assembly precisely adjusted to the respective screw size for the TORX®, TORX PLUS® and hexagon socket screw profiles.

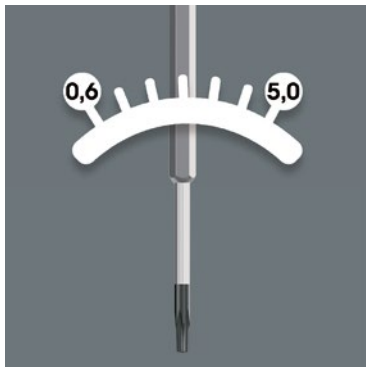

Non-adjustable and tamperproof.



Distinctly audible and noticeable excess-load signal when the pre-set torque is reached.



Slim 4 mm hexagon blades to reach screws in difficult-to-access places.

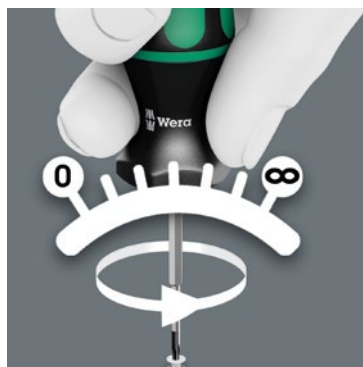

Unlimited torque for loosening seized screws.



Multi-component Kraftform handle with hard and soft zones for fast working speeds and protecting the palm of the hand.



61009K40
Z = -55.736
X = -51.164

TX 10
20Nm
021934

TX 10
20Nm



Series

Torque-indicators

Pre-set torque models

300 Hex torque-indicator



- Application:** Hexagon socket screws
- Pre-set torque:** 1.4 Nm-3.0 Nm (1.0 ft.lb.-2.2 ft.lb.), fixed pre-sets
- Accuracy:** ±10 %
- Blade:** Hexagonal, 4 mm, reduced diameter tip
- Design:** Hex-Plus, Black Point
- Handle:** Kraftform with non-roll feature, multi-component

		Nm	ft. lb.					
				mm	mm	mm	mm	"
05027910001	2,0	1,4	1,0	4	3,5	65	105	2 9/16"
05027911001	2,5	2,0	1,5	4	3,8	65	105	2 9/16"
05027912001	3,0	3,0	2,2	4	3,8	65	105	2 9/16"

300 IP TORX PLUS® torque-indicator



- Application:** TORX PLUS® socket screws
- Pre-set torque:** 0.6 Nm-3.0 Nm (0.4 ft.lb.-3.0 ft.lb.), fixed pre-sets
- Accuracy:** ±10 %
- Blade:** Hexagonal, 4 mm, reduced diameter tip
- Design:** Black Point
- Handle:** Kraftform with non-roll feature, multi-component

		Nm	ft. lb.					
				mm	mm	mm	mm	"
05028040001	6 IP	0,6	0,4	4	3,5	65	105	2 9/16"
05028041001	7 IP	0,9	0,7	4	3,5	65	105	2 9/16"
05028042001	8 IP	1,2	0,9	4	3,5	65	105	2 9/16"
05028043001	9 IP	1,4	1,0	4	3,5	65	105	2 9/16"
05028044001	10 IP	2,0	1,5	4	3,8	65	105	2 9/16"
05028045001	15 IP	3,0	2,2	4	3,8	65	105	2 9/16"

300 Hex torque-indicator, pistol grip



- Application:** Hexagon socket screws
- Pre-set torque:** 5.0 Nm (3.7 ft. lb.), fixed pre-set
- Accuracy:** ±10 %
- Blade:** Hexagonal, 8 mm, reduced diameter tip
- Design:** Hex-Plus, Black Point
- Handle:** Kraftform pistol grip, multi-component

		mm	mm	mm	mm	mm	"
05027913001	4,0	160	100	65	2 9/16"	25	1"

300 TX TORX® torque-indicator



- Application:** TORX® socket screws
- Pre-set torque:** 0.6 Nm-3.0 Nm (0.4 ft.lb.-2.2 ft.lb.), fixed pre-sets
- Accuracy:** ±10 %
- Blade:** Hexagonal, 4 mm, reduced diameter tip
- Design:** Black Point
- Handle:** Kraftform with non-roll feature, multi-component

		Nm	ft. lb.					
				mm	mm	mm	mm	"
05027930001	TX 6	0,6	0,4	4	3,5	65	105	2 9/16"
05027931001	TX 7	0,9	0,7	4	3,5	65	105	2 9/16"
05027932001	TX 8	1,2	0,9	4	3,5	65	105	2 9/16"
05027933001	TX 9	1,4	1,0	4	3,5	65	105	2 9/16"
05027934001	TX 10	2,0	1,5	4	3,8	65	105	2 9/16"
05027935001	TX 15	3,0	2,2	4	3,8	65	105	2 9/16"

300 IP TORX PLUS® torque-indicator, pistol grip



- Application:** TORX PLUS® socket screws
- Pre-set torque:** 5.0 Nm (3.7 ft. lb.), fixed pre-set
- Accuracy:** ±10 %
- Blade:** Hexagonal, 8 mm, reduced diameter tip
- Design:** Black Point
- Handle:** Kraftform pistol grip, multi-component

		mm	mm	mm	mm	mm	mm
05028046001	20 IP	160	100	65	2 9/16"	25	1"

300 TX TORX® torque-indicator, pistol grip



- Application:** TORX® socket screws
- Pre-set torque:** 5.0 Nm (3.7 ft. lb.), fixed pre-set
- Accuracy:** ±10 %
- Blade:** Hexagonal, 8 mm, reduced diameter tip
- Design:** Black Point
- Handle:** Kraftform pistol grip, multi-component

		mm	mm	mm	mm	mm	mm
05027936001	TX 20	160	100	65	2 9/16"	25	1"

Tip

Less is often more

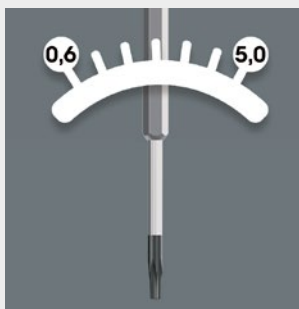

unlimited loosening torque, two handles, tamper-proof.

Some screw connections require specific torque values so that they can be tightened or loosened easily. Wera torque-indicators are pre-set to torque values recommended by leading carbide tool manufacturers. Pre-set torque between 0.6 Nm and 5.0 Nm, for TORX®, TORX PLUS® and hexagon socket screws,





Click-Torque Wrench Series

We wanted working with torque wrenches to be simple and accurate – which is why we developed the Click-Torque wrenches.

With the ability to set and save the default values and with the unmistakable, robust Wera design, these torque wrenches are the ideal tools for all bolting applications that require torque-controlled tightening (clockwise torque wrenches) and tightening and loosening (torque wrenches for insert tools).



Precise to $\pm 3\%$ as per DIN EN ISO 6789-1:2017-07.



Easy setting and saving of the desired torque value; readable on the main and fine scales.



With audible and tactile clicks when adjusting the scale values.

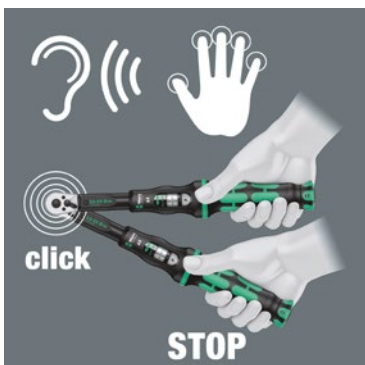

When the set torque value is reached, an audible and tactile mechanism triggers.



Very robust design with reversible ratchet (45 teeth) or for insert tools (9x12 mm or 14x18 mm) and ergonomic 2-component handle.

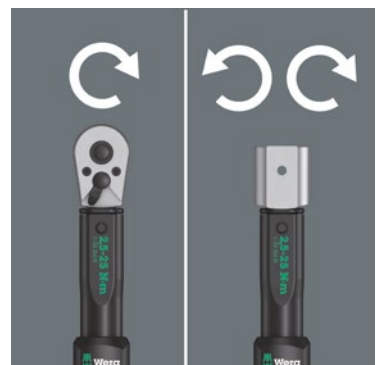

The reversible Click-Torque wrenches are for right-handed use, the Click-Torque wrenches for insert tools are suitable for right-hand and left-hand uses.



The Click-Torque wrenches are available for clockwise torque-controlled tightening with a reversible ratchet ($\frac{1}{4}$ " , $\frac{3}{8}$ " , $\frac{1}{2}$ " and $\frac{3}{4}$ " drive) or for insert tools (9x12 mm, 14x18 mm) for torque ranges from 2.5 Nm to 1000 Nm.

All Wera Click-Torque wrenches manufactured according to DIN EN ISO 6789 are supplied with a Declaration of conformity. Our workshop offers a comprehensive service for all Wera torque tools. Please contact us with any queries regarding service, recalibration or repair on +49 (0)202 40 45 145; Fax: +49 (0)202 40 45 158 or per E-Mail at: torqueservice@wera.de.



Series Click-Torque

Adjustable torque wrenches

Click-Torque A 5 torque wrench with reversible ratchet

















Application: For clockwise torque-control

Precision: ± 4% of set value, as per DIN EN ISO 6789-1: 2017-07

Design: With ¼" square drive, reversible ratchet, 45 teeth; easy setting and saving of the desired torque value, with audible and tactile locking when the scale values are reached (fine scale only in Newton meters), audible and tactile release mechanism when the set torque value is reached

Handle: Ergonomic 2-component handle

														
		Nm	Nm	lbf. ft.	mm	mm	mm	mm	mm	mm	mm	mm	mm	mm
05075604001	¼"	2,5-25	0,10	1-18	290	121	42	25	11,5	11 27/64"	4 49/64"	1 21/32"	1"	7/16"

Click-Torque A 6 torque wrench with reversible ratchet

















Application: For clockwise torque-control

Precision: ± 4% of set value, as per DIN EN ISO 6789-1: 2017-07

Design: With ¼" hex drive, reversible ratchet, 45 teeth; easy setting and saving of the desired torque value, with audible and tactile locking when the scale values are reached (fine scale only in Newton meters), audible and tactile release mechanism when the set torque value is reached

Handle: Ergonomic 2-component handle

														
		Nm	Nm	lbf. ft.	mm	mm	mm	mm	mm	mm	mm	mm	mm	mm
05075605001	¼"	2,5-25	0,10	1-18	290	121	42	25	11,5	11 27/64"	4 49/64"	1 21/32"	1"	7/16"



Series Click-Torque

Adjustable torque wrenches

Click-Torque B 1 torque wrench with reversible ratchet



Application: For clockwise torque-control

Precision: ± 3% of set value, as per DIN EN ISO 6789-1: 2017-07

Design: With $\frac{3}{8}$ " square drive, reversible ratchet, 45 teeth; easy setting and saving of the desired torque value, with audible and tactile locking when the scale values are reached (fine scale only in Newton meters), audible and tactile release mechanism when the set torque value is reached

Handle: Ergonomic 2-component handle

		Nm	Nm	lbf. ft.	mm	mm	mm	mm	mm	mm	mm	mm	mm	mm
05075610001	$\frac{3}{8}$ "	10-50	0,25	8-36	360	140	47	35	16,5	14 $\frac{11}{64}$ "	5 $\frac{33}{64}$ "	1 $\frac{27}{32}$ "	1 $\frac{3}{8}$ "	$\frac{5}{8}$ "

Click-Torque B 2 torque wrench with reversible ratchet



Application: For clockwise torque-control

Precision: ± 3% of set value, as per DIN EN ISO 6789-1: 2017-07

Design: With $\frac{3}{8}$ " square drive, reversible ratchet, 45 teeth; easy setting and saving of the desired torque value, with audible and tactile locking when the scale values are reached (fine scale only in Newton meters), audible and tactile release mechanism when the set torque value is reached

Handle: Ergonomic 2-component handle

		Nm	Nm	lbf. ft.	mm	mm	mm	mm	mm	mm	mm	mm	mm	mm
05075611001	$\frac{3}{8}$ "	20-100	0,5	15-73	405	140	47	43	18,5	15 $\frac{15}{16}$ "	5 $\frac{33}{64}$ "	1 $\frac{27}{32}$ "	1 $\frac{11}{16}$ "	$\frac{45}{64}$ "

Click-Torque C 1 torque wrench with reversible ratchet



Application: For clockwise torque-control

Precision: ± 3% of set value, as per DIN EN ISO 6789-1: 2017-07

Design: With 1/2" square drive, reversible ratchet, 45 teeth; easy setting and saving of the desired torque value, with audible and tactile locking when the scale values are reached (fine scale only in Newton meters), audible and tactile release mechanism when the set torque value is reached

Handle: Ergonomic 2-component handle

		Nm	Nm	lbf. ft.	mm	mm	mm	mm	mm	mm	mm	mm	mm	mm
05075620001	1/2"	10-50	0,25	8-36	360	140	47	35	16,5	14 11/64"	5 33/64"	1 27/32"	1 3/8"	5/8"

Click-Torque C 2 torque wrench with reversible ratchet



Application: For clockwise torque-control

Precision: ± 3% of set value, as per DIN EN ISO 6789-1: 2017-07

Design: With 1/2" square drive, reversible ratchet, 45 teeth; easy setting and saving of the desired torque value, with audible and tactile locking when the scale values are reached (fine scale only in Newton meters), audible and tactile release mechanism when the set torque value is reached

Handle: Ergonomic 2-component handle

		Nm	Nm	lbf. ft.	mm	mm	mm	mm	mm	mm	mm	mm	mm	mm
05075621001	1/2"	20-100	0,5	15-73	405	140	47	43	18,5	15 15/16"	5 33/64"	1 27/32"	1 11/16"	45/64"



Series Click-Torque

Adjustable torque wrenches

Click-Torque C 3 torque wrench with reversible ratchet

















Application: For clockwise torque-control

Precision: ± 3% of set value, as per DIN EN ISO 6789-1: 2017-07

Design: With 1/2" square drive, reversible ratchet, 45 teeth; easy setting and saving of the desired torque value, with audible and tactile locking when the scale values are reached (fine scale only in Newton meters), audible and tactile release mechanism when the set torque value is reached

Handle: Ergonomic 2-component handle

														
		Nm	Nm	lbf. ft.	mm	mm	mm	mm	mm	mm	mm	mm	mm	mm
05075622001	1/2"	40-200	1,0	30-146	510	140	47	43	18,5	20 5/64"	5 33/64"	1 27/32"	1 11/16"	45/64"

Click-Torque C 4 torque wrench with reversible ratchet

















Application: For clockwise torque-control

Precision: ± 3% of set value, as per DIN EN ISO 6789-1: 2017-07

Design: With 1/2" square drive, reversible ratchet, 45 teeth; easy setting and saving of the desired torque value, with audible and tactile locking when the scale values are reached (fine scale only in Newton meters), audible and tactile release mechanism when the set torque value is reached

Handle: Ergonomic 2-component handle

														
		Nm	Nm	lbf. ft.	mm	mm	mm	mm	mm	mm	mm	mm	mm	mm
05075623001	1/2"	60-300	1,0	45-220	595	140	47	43	18,5	23 27/64"	5 33/64"	1 27/32"	1 11/16"	45/64"

Click-Torque C 5 torque wrench with reversible ratchet



Application: For clockwise torque-control

Precision: Accuracy $\pm 3\%$ of set value, as per DIN EN ISO 6789-1: 2017-07; application range with up to max. 400 Nm above standard
DIN EN ISO 6789-1: 2017-07 (maximum value: 340 Nm)

Design: With $\frac{1}{2}$ " square drive, reversible ratchet, 45 teeth; easy setting and saving of the desired torque value, with audible and tactile locking when the scale values are reached (fine scale only in Newton meters), audible and tactile release mechanism when the set torque value is reached

Handle: Ergonomic 2-component handle

		Nm	Nm	lbf. ft.	mm	mm	mm	mm	mm	mm	mm	mm	mm	mm
05075624001	$\frac{1}{2}$ "	80-400	1,0	60-295	680	140	47	43	18,5	26 $\frac{49}{64}$ "	5 $\frac{33}{64}$ "	1 $\frac{27}{32}$ "	1 $\frac{11}{16}$ "	$\frac{45}{64}$ "

¹ available from September 2018

Click-Torque E 1 torque wrench with reversible ratchet



Application: For clockwise torque-control

Precision: $\pm 3\%$ of set value, as per DIN EN ISO 6789-1: 2017-07

Design: With $\frac{3}{4}$ " square drive, reversible ratchet, 45 teeth; easy setting and saving of the desired torque value, with audible and tactile locking when the scale values are reached (fine scale only in Newton meters), audible and tactile release mechanism when the set torque value is reached

Handle: Ergonomic 2-component handle

		Nm	Nm	lbf. ft.	mm	mm	mm	mm	mm	mm	mm	mm	mm	mm
05075630001	$\frac{3}{4}$ "	200-1000	1,0	148-737	1250	140	47	63	30	49 $\frac{7}{32}$ "	5 $\frac{33}{64}$ "	1 $\frac{27}{32}$ "	2 $\frac{31}{64}$ "	1 $\frac{3}{16}$ "

¹ available from January 2019

Series Click-Torque

Adjustable torque wrenches

Click-Torque X 1 torque wrench for insert tools

















Application: For right and left-handed use

Precision: ± 4% of set value, as per DIN EN ISO 6789-1: 2017-07

Design: For 9x12 mm interchangeable insert tools; easy setting and saving of the desired torque value, with audible and tactile locking when the scale values are reached (fine scale only in Newton meters), audible and tactile release mechanism when the set torque value is reached

Handle: Ergonomic 2-component handle

														
		Nm	Nm	lbf. ft.	mm	mm	mm	mm	mm	mm	mm	mm	mm	mm
05075651001	9x12	2,5-25	0,10	4-18	283	121	42	24	20	11 ⁹ / ₆₄ "	4 ⁴⁹ / ₆₄ "	1 ²¹ / ₃₂ "	15/ ₁₆ "	25/ ₃₂ "

Click-Torque X 2 torque wrench for insert tools

















Application: For right and left-handed use

Precision: ± 3% of set value, as per DIN EN ISO 6789-1: 2017-07

Design: For 9x12 mm interchangeable insert tools; easy setting and saving of the desired torque value, with audible and tactile locking when the scale values are reached (fine scale only in Newton meters), audible and tactile release mechanism when the set torque value is reached



Handle: Ergonomic 2-component handle

														
		Nm	Nm	lbf. ft.	mm	mm	mm	mm	mm	mm	mm	mm	mm	mm
05075652001	9x12	10-50	0,25	8-36	338	140	47	29	20	13 ⁵ / ₁₆ "	5 ³³ / ₆₄ "	1 ²⁷ / ₃₂ "	1 ⁹ / ₆₄ "	25/ ₃₂ "

Click-Torque X 3 torque wrench for insert tools



- Application:** For right and left-handed use
- Precision:** ± 3% of set value, as per DIN EN ISO 6789-1: 2017-07
- Design:** For 9x12 mm interchangeable insert tools; easy setting and saving of the desired torque value, with audible and tactile locking when the scale values are reached (fine scale only in Newton meters), audible and tactile release mechanism when the set torque value is reached
- Handle:** Ergonomic 2-component handle

	
05075653001	9x12 20-100 0,5 15-73 372 140 47 29 20 14 ⁴¹ / ₆₄ " 5 ³³ / ₆₄ " 1 ²⁷ / ₃₂ " 1 ⁹ / ₆₄ " ²⁵ / ₃₂ "

Click-Torque X 4 torque wrench for insert tools

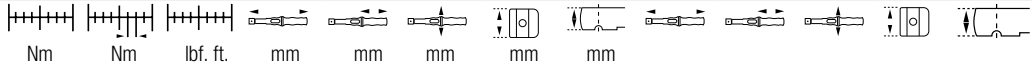

- Application:** For right and left-handed use
- Precision:** ± 3% of set value, as per DIN EN ISO 6789-1: 2017-07
- Design:** For 14x18 mm interchangeable insert tools; easy setting and saving of the desired torque value, with audible and tactile locking when the scale values are reached (fine scale only in Newton meters), audible and tactile release mechanism when the set torque value is reached
- Handle:** Ergonomic 2-component handle

	
05075654001	14x18 40-200 1,0 30-146 480 140 47 32 26 18 ⁵⁷ / ₆₄ " 5 ³³ / ₆₄ " 1 ²⁷ / ₃₂ " 1 ¹⁷ / ₆₄ " 1 ¹ / ₃₂ "



Series Click-Torque

Adjustable torque wrenches

Click-Torque X 5 torque wrench for insert tools



Application: For right and left-handed use

Precision: ± 3% of set value, as per DIN EN ISO 6789-1: 2017-07

Design: For 14x18 mm interchangeable insert tools; easy setting and saving of the desired torque value, with audible and tactile locking when the scale values are reached (fine scale only in Newton meters), audible and tactile release mechanism when the set torque value is reached

Handle: Ergonomic 2-component handle

		Nm	Nm	lbf. ft.	mm	mm	mm	mm	mm	mm	mm	mm	mm	mm
05075655001	14x18	60-300	1,0	45-220	570	140	47	32	26	22 7/16"	5 33/64"	1 27/32"	1 17/64"	1 1/32"

Click-Torque X 6 torque wrench for insert tools



Application: For right and left-handed use

Precision: ± 3% of set value, as per DIN EN ISO 6789-1: 2017-07; application range with up to max. 400 Nm above standard DIN EN ISO 6789-1: 2017-07 (maximum value: 340 Nm)

Design: For 14x18 mm interchangeable insert tools; easy setting and saving of the desired torque value, with audible and tactile locking when the scale values are reached (fine scale only in Newton meters), audible and tactile release mechanism when the set torque value is reached

Handle: Ergonomic 2-component handle

		Nm	Nm	lbf. ft.	mm	mm	mm	mm	mm	mm	mm	mm	mm	mm
05075656001	14x18	80-400	1,0	60-295	655	140	47	32	26	25 25/32"	5 33/64"	1 27/32"	1 17/64"	1 1/32"

¹ available from September 2018



40-200 N·m
30-140 lb-ft



Series Insert Tools

Suitable for Series Click-Torque X torque wrenches.

7770 Open end insert

Form A

05078600001
05078601001
05078602001
05078603001
05078604001
05078605001







Form B

05078606001
05078607001
05078608001
05078609001
05078610001
05078611001
05078612001



Application: Hexagon screw heads or nuts
Drive: 9x12 mm; for torque wrenches of the Click-Torque X series with 9x12 mm holder
Design: Forged, chrome vanadium steel, matt chrome plated; with safety pin

					
	mm	mm	mm	mm	mm
05078600001	7	39,0	22,0	22,0	5,0
05078601001	8	39,0	22,0	22,0	5,0
05078602001	9	39,0	22,0	22,0	5,0
05078603001	10	39,0	22,0	22,0	5,0
05078604001	11	39,0	22,0	22,0	5,0
05078605001	12	39,0	22,0	22,0	5,0
05078606001	13	41,0	24,0	30,0	7,0
05078607001	14	41,0	24,0	30,0	7,0
05078608001	15	41,0	24,0	30,0	7,0
05078609001	16	41,0	24,0	30,0	7,0
05078610001	17	41,0	24,0	30,0	7,0
05078611001	18	41,0	24,0	30,0	7,0
05078612001	19	41,0	24,0	30,0	7,0

7780 Open end insert

Form A

05078670001



Form B

05078671001
05078672001
05078673001
05078674001
05078675001
05078676001



Form C

05078677001
05078678001
05078679001
05078680001
05078681001







Form D

05078682001
05078683001
05078684001
05078685001
05078686001
05078687001



Application: Hexagon screw heads or nuts
Drive: 14x18 mm; for torque wrenches of the Click-Torque X series with 14x18 mm holder
Design: Forged, chrome vanadium steel, matt chrome plated; with safety pin

					
	mm	mm	mm	mm	mm
05078670001	13	56,0	32,0	30,0	7,0
05078671001	14	58,0	33,0	32,0	7,0
05078672001	15	58,0	33,0	32,0	7,0
05078673001	16	58,0	33,0	32,0	7,0
05078674001	17	58,0	33,0	32,0	7,0
05078675001	18	58,0	33,0	32,0	7,0
05078676001	19	58,0	33,0	32,0	7,0
05078677001	21	61,0	36,0	52,0	12,0
05078678001	22	61,0	36,0	52,0	12,0
05078679001	24	61,0	36,0	52,0	12,0
05078680001	26	61,0	36,0	52,0	12,0
05078681001	27	61,0	36,0	52,0	12,0
05078682001	29	61,0	36,0	52,0	12,0
05078683001	30	61,0	36,0	52,0	12,0
05078684001	32	61,0	36,0	52,0	12,0
05078685001	36	61,0	36,0	52,0	12,0
05078686001	38	61,0	36,0	52,0	12,0
05078687001	41	61,0	36,0	52,0	12,0

7771 Ring spanner insert

Form A

05078620001
05078621001
05078622001
05078623001
05078624001



Form B

05078625001
05078626001
05078627001
05078628001
05078629001
05078630001
05078631001
05078632001



Form C





05078633001



Application: Hexagon screw heads or nuts

Drive: 9x12 mm; for torque wrenches of the Click-Torque X series with 9x12 mm holder

Design: Forged, chrome vanadium steel, matt chrome plated; with safety pin

					
	mm	mm	mm	mm	mm
05078620001	7	41,0	24,0	22,0	8,0
05078621001	8	41,0	24,0	22,0	8,0
05078622001	9	41,0	24,0	22,0	8,0
05078623001	10	41,0	24,0	22,0	8,0
05078624001	11	41,0	24,0	22,0	8,0
05078625001	12	44,0	27,0	22,0	11,0
05078626001	13	44,0	27,0	22,0	11,0
05078627001	14	44,0	27,0	22,0	11,0
05078628001	15	44,0	27,0	22,0	11,0
05078629001	16	44,0	27,0	22,0	11,0
05078630001	17	44,0	27,0	22,0	11,0
05078631001	18	44,0	27,0	22,0	11,0
05078632001	19	44,0	27,0	22,0	11,0
05078633001	21	51,0	34,0	33,0	15,0

7781 Ring spanner insert

Form A

05078690001
05078691001
05078692001



Form B

05078693001
05078694001
05078695001
05078696001
05078697001
05078698001
05078699001



Form C





05078700001
05078701001
05078702001
05078703001
05078704001
05078705001



Application: Hexagon screw heads or nuts

Drive: 14x18 mm; for torque wrenches of the Click-Torque X series with 14x18 mm holder

Design: Forged, chrome vanadium steel, matt chrome plated; with safety pin

					
	mm	mm	mm	mm	mm
05078690001	13	62,0	37,0	30,0	11,0
05078691001	14	62,0	37,0	30,0	11,0
05078692001	15	62,0	37,0	30,0	11,0
05078693001	16	64,0	39,0	28,0	12,0
05078694001	17	64,0	39,0	28,0	12,0
05078695001	18	64,0	39,0	28,0	12,0
05078696001	19	64,0	39,0	28,0	12,0
05078697001	21	64,0	39,0	28,0	12,0
05078698001	22	64,0	39,0	28,0	12,0
05078699001	24	64,0	39,0	28,0	12,0
05078700001	27	81,0	56,0	53,0	21,0
05078701001	30	81,0	56,0	53,0	21,0
05078702001	32	81,0	56,0	53,0	21,0
05078703001	34	81,0	56,0	53,0	21,0
05078704001	36	81,0	56,0	53,0	21,0
05078705001	41	81,0	56,0	53,0	21,0

Series Insert Tools

Suitable for Series Click-Torque X torque wrenches.

7772 A Ratchet insert, reversible



Application: For 1/4" square socket wrench inserts and 1/4" connecting parts with square drive

Drive: 9x12 mm; for torque wrenches of the Click-Torque X series with 9x12 mm holder

Design: With reversing ratchet, push-button release, forged, chrome-vanadium steel, matt chrome-plated; with safety pin

		mm	mm	mm	mm
05078635001	1/4"	49,0	32,0	28,0	15,0

7772 B Ratchet insert, reversible



Application: For 3/8" square socket wrench inserts and 3/8" connecting parts with square drive

Drive: 9x12 mm; for torque wrenches of the Click-Torque X series with 9x12 mm holder

Design: With reversing ratchet, push-button release, forged, chrome-vanadium steel, matt chrome-plated; with safety pin

		mm	mm	mm	mm
05078636001	3/8"	52,0	35,0	35,0	21,0

7772 C Ratchet insert, reversible



Application: For 1/2" square socket wrench inserts and 1/2" connecting parts with square drive

Drive: 9x12 mm; for torque wrenches of the Click-Torque X series with 9x12 mm holder

Design: With reversing ratchet, push-button release, forged, chrome-vanadium steel, matt chrome-plated; with safety pin

		mm	mm	mm	mm
05078637001	1/2"	58,0	41,0	42,0	23,0

7782 E Ratchet insert, reversible



Application: For 3/4" square socket wrench inserts and 3/4" connecting parts with square drive

Drive: 14x18 mm; for torque wrenches of the Click-Torque X series with 14x18 mm holder

Design: With reversing ratchet, push-button release, forged, chrome-vanadium steel, matt chrome-plated; with safety pin

		mm	mm	mm	mm
05078708001	3/4"	90,0	65,0	65,0	36,0

7782 C Ratchet insert, reversible



Application: For 1/2" square socket wrench inserts and 1/2" connecting parts with square drive

Drive: 14x18 mm; for torque wrenches of the Click-Torque X series with 14x18 mm holder

Design: With reversing ratchet, push-button release, forged, chrome-vanadium steel, matt chrome-plated; with safety pin

		mm	mm	mm	mm
05078707001	1/2"	66,0	41,0	42,0	23,0

7773 A Square drive insert



Application: For 1/4" square socket wrench inserts and 1/4" connecting parts with square drive

Drive: 9x12 mm; for torque wrenches of the Click-Torque X series with 9x12 mm holder

Design: Forged, chrome-vanadium steel, matt chrome-plated; with safety pin

		mm	mm	mm	mm
05078200001	1/4"	44,0	28,0	21,0	14,0

7773 B Square drive insert



Application: For $\frac{3}{8}$ " square socket wrench inserts and $\frac{3}{8}$ " connecting parts with square drive

Drive: 9x12 mm; for torque wrenches of the Click-Torque X series with 9x12 mm holder

Design: Forged, chrome-vanadium steel, matt chrome-plated; with safety pin

		mm	mm		
05078205001	$\frac{3}{8}$ "	44,0	28,0	21,0	14,0

7783 C Square drive insert



Application: For $\frac{1}{2}$ " square socket wrench inserts and $\frac{1}{2}$ " connecting parts with square drive

Drive: 14x18 mm; for torque wrenches of the Click-Torque X series with 14x18 mm holder

Design: Forged, chrome-vanadium steel, matt chrome-plated; with safety pin

		mm	mm		
05078345001	$\frac{1}{2}$ "	65,0	40,0	30,0	18,0

7773 C Square drive insert



Application: For $\frac{1}{2}$ " square socket wrench inserts and $\frac{1}{2}$ " connecting parts with square drive

Drive: 9x12 mm; for torque wrenches of the Click-Torque X series with 9x12 mm holder

Design: Forged, chrome-vanadium steel, matt chrome-plated; with safety pin

		mm	mm	mm	mm
05078210001	$\frac{1}{2}$ "	44,0	28,0	21,0	14,0

7774/1 Bit adapter insert, $\frac{1}{4}$ "



Application: Suitable for $\frac{1}{4}$ " DIN ISO 1173-C 6,3 hexagon insert bits and Wera Series 1

Drive: 9x12 mm; for torque wrenches of the Click-Torque X series with 9x12 mm holder

Design: Forged, chrome-vanadium steel, matt chrome-plated; with safety pin

		mm	mm	mm	mm
05078640001	$\frac{1}{4}$ "	42,0	25,0	22,0	12,5

7783 E Push-through square insert tool



Application: For $\frac{1}{2}$ " square socket wrench inserts and $\frac{3}{4}$ " connecting parts with square drive

Drive: 14x18 mm; for torque wrenches of the Click-Torque X series with 14x18 mm holder

Design: With push-through square with ball lock, forged, chrome-vanadium steel, matt chrome-plated; with safety pin

		mm	mm	mm	mm
05078710001	$\frac{3}{4}$ "	70,0	45,0	40,0	25,0

7774/2 Bit adapter insert, $\frac{5}{16}$ "



Application: Suitable for $\frac{5}{16}$ " DIN ISO 1173-E 8 hexagon insert bits and Wera Series 2

Drive: 9x12 mm; for torque wrenches of the Click-Torque X series with 9x12 mm holder

Design: Forged, chrome-vanadium steel, matt chrome-plated; with safety pin

		mm	mm	mm	mm
05078641001	$\frac{5}{16}$ "	42,0	25,0	22,0	12,5

Series Insert Tools

Suitable for Series Click-Torque X torque wrenches.





7774/3 Bit adapter insert, 5/16" "



Application: Suitable for 5/16" DIN ISO 1173-E 8 hexagon insert bits and Wera Series 2

Drive: 14x18 mm; for torque wrenches of the Click-Torque X series with 14x18 mm holder

Design: Forged, chrome-vanadium steel, matt chrome-plated; with safety pin

					
	mm	mm	mm	mm	mm
05078642001	5/16"	58,0	33,0	30,0	13,0

7775 Open ring spanner insert

Form A

05078650001
05078651001
05078652001
05078653001
05078654001
05078655001



Form B





05078656001
05078657001
05078658001



Application: Hexagon screw heads or nuts

Drive: 9x12 mm; for torque wrenches of the Click-Torque X series with 9x12 mm holder

Design: Forged, chrome vanadium steel, matt chrome plated; with safety pin

					
	mm	mm	mm	mm	mm
05078650001	10	44,0	27,0	22,0	11,0
05078651001	11	44,0	27,0	22,0	11,0
05078652001	12	44,0	27,0	22,0	11,0
05078653001	13	44,0	27,0	22,0	11,0
05078654001	14	44,0	27,0	22,0	11,0
05078655001	17	44,0	27,0	22,0	11,0
05078656001	18	49,0	32,0	33,0	15,0
05078657001	19	49,0	32,0	33,0	15,0
05078658001	22	49,0	32,0	33,0	15,0

7776 External TORX® insert

Form A

05078660001
05078661001
05078662001
05078663001



Form B





05078664001



Application: External TORX® screws

Drive: 9x12 mm; for torque wrenches of the Click-Torque X series with 9x12 mm holder

Design: Forged, chrome-vanadium steel, matt chrome-plated; with safety pin

					
	mm	mm	mm	mm	mm
05078660001	TX 6	40,0	23,0	22,0	8,0
05078661001	TX 8	40,0	23,0	22,0	8,0
05078662001	TX 10	40,0	23,0	22,0	8,0
05078663001	TX 12	40,0	23,0	22,0	8,0
05078664001	TX 14	45,0	28,0	22,0	11,0

7786 External TORX® insert

Form A

05078714001
05078715001



Form B





05078716001
05078717001



Application: External TORX® screws

Drive: 14x18 mm; for torque wrenches of the Click-Torque X series with 14x18 mm holder

Design: Forged, chrome-vanadium steel, matt chrome-plated; with safety pin

					
	mm	mm	mm	mm	mm
05078714001	TX 14	37,0	62,0	30,0	11,0
05078715001	TX 18	37,0	62,0	30,0	11,0
05078716001	TX 20	40,0	65,0	32,0	12,0
05078717001	TX 24	40,0	65,0	32,0	12,0







7779/1 Adapter insert



Application: For the use of square plug-in tools 14x18 mm in torque wrenches with internal square 9x12 mm

Drive: 9x12 mm; for torque wrenches of the Click-Torque X series with 9x12 mm holder

Design: Forged, chrome vanadium steel, matt chrome plated; with safety pin

						
	mm	mm	mm	mm	mm	mm
05078666001	14x18	9x12	49,0	33,0	32,0	26,0







7779/2 Adapter insert



Application: For the use of square plug-in tools 9x12 mm in torque wrenches with internal square 14x18 mm

Drive: 14x18 mm; for torque wrenches of the Click-Torque X series with 14x18 mm holder

Design: Forged, chrome vanadium steel, matt chrome plated; with safety pin

						
	mm	mm	mm	mm	mm	mm
05078667001	9x12	14x18	52,0	27,0	28,0	21,0





7790/1 Push-fit weld-on adapter



Application: For welding on specifically required tools

Drive: 9x12 mm; for torque wrenches of the Click-Torque X series with 9x12 mm holder

Design: Forged, phosphated, with safety pin

				
	mm	mm	mm	mm
05078720001	24,0	8,0	22,0	14,0





7790/2 Push-fit weld-on adapter



Application: For welding on specifically required tools

Drive: 14x18 mm; for torque wrenches of the Click-Torque X series with 14x18 mm holder

Design: Forged, phosphated, with safety pin

					
	mm	mm	mm	mm	mm
05078721001	38,0	13,0	31,0	22,0	26,0





Impact Driver and Soft-faced Hammers



Impact Driver

510



Soft-faced Hammers

512



Impact driver

It has to be possible that even the most seized screw can be loosened.

Impact drivers are the solution whenever manual power is insufficient and a pneumatic screwdriver is not to hand.

The Wera impact driver has particularly high efficiency thanks to its robust double-curved design. Impact forces are converted into rotary motion and so there is no need for the use of pneumatic appliances.



Seized screws can be loosened or tightened without power tools.





The double-curved design is particularly efficient.



2090 Impact driver 90 Nm



Application: Screws M 4 - M 8
Output: $\frac{5}{16}$ " hexagon socket









		
	mm	
05072014001	142,0	5 ¹⁹ / ₃₂ "

2090/17 Impact driver set



17-piece set; in a surface-preserving, compact and extremely robust textile box; low volume and weight for simplified mobility

1x 2090 impact driver 90 Nm, $\frac{5}{16}$ " hexagon socket; 1 adaptor $\frac{5}{16}$ " external hexagon/ $\frac{3}{8}$ " external square, 1 adaptor $\frac{5}{16}$ " external hexagon/ $\frac{1}{2}$ " external square, 14 bits

		
05072017001		
	2090 90 Nm	1 x 142,0
	851/2 Z PH	1 x PH 2x32; 1 x PH 3x32
	851/2 PH	1 x PH 4x32
	800/2	1 x 2,0x12,0x41
	840/2 Z	1 x 5x30; 1 x 6x30; 1 x 8x30; 1 x 10x30
	840/2	1 x 7,0x30
	867/2 Z TORX®	1 x TX 30x35; 1 x TX 40x35; 1 x TX 45x35; 1 x TX 50x35; 1 x TX 55x35
	870/2	1 x 3/8"x5/16"; 1 x 1/2"x5/16"



Soft-faced hammers

Powerful hammering with surface protection.



They come in soft, medium and hard designs for a wide range of applications from universal use to splinter-free applications on sharp-edged work pieces.

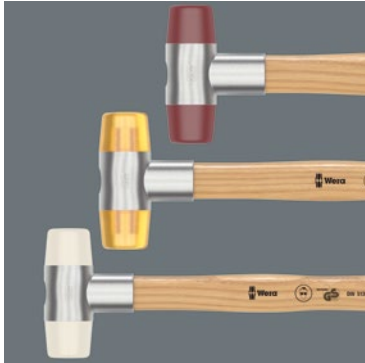

Powerful work is ensured with handles out of high quality ash wood.



Colour guidance system

- Yellow = Repair/maintenance work with high demands
- Red = Suitable for hammering sharp-edged work pieces; bodyshops, automotive, engineering
- White = Suitable for metal processing and removal of dents; tent, large building and exhibition stand construction



The double-sided conical design creates an unbreakable and secure link between the handle and head of the hammer.



Versatile use thanks to the soft faced heads that can be retrospectively fitted.





Wera





Series Soft-Faced Hammers

Powerful hammering with surface protection

100 Soft-faced hammer with Cellidor head sections





Application: Demanding repair/maintenance work
Head: Cellidor, hard
Handle: Ashwood

	#	 mm	 mm	 mm
0500005001	1	22	75	250,0
05000010001	2	27	90	265,0
05000015001	3	32	95	280,0
05000020001	4	35	105	290,0
05000025001	5	40	110	320,0
05000030001	6	50	115	340,0
05000035001	7	60	135	380,0

101 Soft-faced hammer with nylon head sections





Application: Metal processing, removal of dents as well as tent, large building and exhibition stand construction
Head: Nylon, very hard
Handle: Ashwood

	#	 mm	 mm	 mm
05000305001	1	22	75	250,0
05000310001	2	27	90	265,0
05000315001	3	32	95	280,0
05000320001	4	35	105	290,0
05000325001	5	40	110	320,0
05000330001	6	50	115	340,0
05000335001	7	60	135	380,0

102 Soft-faced hammer with urethane head sections



Application: Bodyshops, automotive, engineering
Head: Urethane, medium-hard
Handle: Ashwood

	#	 mm	 mm	 mm
05000505001	1	22	75	250,0
05000510001	2	27	90	265,0
05000515001	3	32	95	280,0
05000520001	4	35	105	290,0
05000525001	5	40	110	320,0
05000530001	6	50	115	340,0
05000535001	7	60	135	380,0

100 S Replacement ashwood handles for hammers 100, 101, 102



	#	 mm
05000205001	1	250,0
05000210001	2	265,0
05000215001	3	280,0
05000220001	4	290,0
05000225001	5	320,0
05000230001	6	340,0
05000235001	7	380,0

100 L Replacement head sections out of Cellidor for hammer 100



Application: Demanding repair/maintenance work

	#	
05000105001	1	22,0
05000110001	2	27,0
05000115001	3	32,0
05000120001	4	35,0
05000125001	5	40,0
05000130001	6	50,0
05000135001	7	60,0

101 L Replacement head sections out of nylon for hammer 101



Application: Metal processing, removal of dents as well as tent, large building and exhibition stand construction

	#	
05000405001	1	22,0
05000410001	2	27,0
05000415001	3	32,0
05000420001	4	35,0
05000425001	5	40,0
05000430001	6	50,0
05000435001	7	60,0

102 L Replacement head sections out of urethane for hammer 102



Application: Bodyshops, automotive, engineering

	#	
05000605001	1	22,0
05000610001	2	27,0
05000615001	3	32,0
05000620001	4	35,0
05000625001	5	40,0
05000630001	6	50,0
05000635001	7	60,0





TechLex - Technical data and information

Wera ABC	518
TORQUE Test Values	522
Dimensions Of Profiles	523
TORQUE Conversion Table	524
Conversion Of Inches To Millimeters	525
Code No. Index	526
Article No. Index	540
Alphabetical Index	551

Wera ABC

Bit-Check

We have had bit ranges in our programme for many years now. In 2016, we put a question mark against everything and came up with a game changer. We wanted bit ranges with bits whose profiles and sizes could be more easily recognised. We wanted bit ranges that were as compact as possible and which were Wera-like at a first glance. We wanted bit ranges with bits that could be removed and reinserted more easily. We wanted bit ranges with as little weight as possible. The new multi-component Bit-Checks satisfy these requirements; the soft material in the lower section of the Bit-Checks ensures that the bits are firmly held yet easy to remove.

BiTorsion

BiTorsion bits have a tempered torsion zone that diverts the kinetic energy of peak loads away from the drive tip. This greatly reduces the risk of breakage and significantly extends the tools' service life. To find these bits in the catalogue look for the letter B after the article number. BiTorsion holders have a torsion zone that diverts the kinetic energy of peak loads away from the drive tip. The combined use of both the BiTorsion bit and holder increases the service life of the tools considerably and thus ensures higher productivity. BiTorsion bits and holders can, however, be used independently of each other and with conventional tools.

Bits, diamond coated

Please see -> diamond coated bits

Bits, extra hard

Please see -> extra hard bits

Bits, titanium nitride coated

Please see -> Titanium nitride coated bits

Bits, tough absorbing

Please see -> tough absorbing bits

BlackLaser

BlackLaser hardened blades for excellent surface protection and a long service life. High corrosion protection.

Black Point Tip

The Wera Black Point tip and a refined hardening process guarantee a long service life and increased corrosion protection.

Click-Torque Wrenches

Click-Torque wrenches in the unmistakable, robust Wera design with high accuracy as per DIN EN ISO 6789-1: 2017-07.

Chiseldriver

The chiseldriver is the solution for jobs that require more than just screwdriving. For fastening, chiselling and loosening seized screws or hose clamps. With an integrated impact cap that extends service life and reduces the risk of splintering. With a pound-thru hexagon blade made from high-grade material for zero-loss transfer of high forces when struck with a hammer. The tough viscous tempered material prevents the blade from splintering or breaking. More TORQUE can be transferred by attaching an open-jawed or ring spanner to the integrated hexagon bolster.

Diamond coated bits

The minute diamond particles on the tip of the bit literally bite into the screw. The secure hold means that less contact pressure is required, which reduces the risk of slipping. To find diamond coated bits in the catalogue look for the letters DC after the article number.

Extra hard bits

Ideal for soft screwdriving. TORQUE increases continuously without any peaks during fastening until the head of the screw reaches the surface of the material. Extra hard bits are made from a special material that extends the tools' service life and reduces the risk of material breakage. To find these bits in the catalogue look for the letter H after the article number.

Flexible Lock System

All rigid Zyklop extensions are fitted with a freewheel sleeve which lets you tighten and loosen screws and bolts quickly and effectively. The premium extensions are also fitted with the flexible lock system. With this system activated, drive handles can be attached permanently to the extension, preventing slipping or accidental loss of the tool. When the system is deactivated the sockets can be attached as usual and changed in a flash.

Hex-Plus Profile

The problem with hexagon socket screws is the easily “rounded” screw recess. This is caused by the sharp edges of the tool pressing against the inside of the screw profile. Gradual wear eventually grinds and destroys the head of the screw. Wera’s Hex-Plus tools provide more contact surface inside the screw profile, which reduces the notching effect and ultimately the deformation of the screw. Hex-Plus tools can also transfer up to 20 % more TORQUE.

Impact bits

Impact bits are designed for use in powerful impact screwdrivers. Impact bits were specifically developed to withstand high power tool forces.

Individual Testing

Our VDE screwdrivers are tested for dielectric strength under a 10,000-volt load to make sure that their most important property, their insulation, has been adequately tested. Each individual Wera VDE screwdriver is subjected to this test to guarantee safe working up to 1,000 volts.

Joker wrenches

The Joker’s holding function means that nuts and bolts can be held in the jaw and easily positioned where they are needed. Fastening on to the thread can then be done quickly and safely, thanks to the innovative special stop-plate which holds the fastener. No more time-wasting searches for dropped nuts and bolts!

Koloss

The ratchet that can also be used officially as a hammer. The Koloss can be used as a reversible, heavy-duty, fine action ratchet that can withstand loads of at least 600 Nm.

Kraftform Handle

The Kraftform handle has been designed to fit snugly in your hand, making blisters and calluses a thing of the past even after long-term use. The hard materials used for the handle promote fast grip adjustments and prevent the skin from sticking to the handle. The softer, anti-slip zones facilitate zero-loss transfer of high forces. This is an unbeatable combination! Work is done with a flick of the wrist!

Kraftform Kompakt

Wera’s compact tools are suitable for manual or machine use. The type of operation often becomes clear only after you’ve arrived at the site. The compact handle/interchangeable blade system offers you mobility and flexibility. The sets come with a Kraftform handle, quick-release chuck and bits for manual and machine use. The handle/interchangeable blade system permits rapid tool changes for a wide range of applications. Tools can be stored and carried in a strong plastic box or a robust belt pouch so that they are always at hand. The sets of series 20 have hidden depths: a telescopic blade that retracts into the handle (which can also be removed and attached to a power tool as a bit holder) and an integrated bit magazine. Rapidaptor technology ensures rapid bit changes.

Kraftform Micro

The three-zone concept of Kraftform Micro screwdrivers reduces fastening times and the cost per screw connection. The hand support on the easy-turning cap and the fast-turning zone below the cap accelerate the screwdriving process. This makes time-consuming grip adjustments, which are required with conventional precision screwdrivers, unnecessary. The power zone has integrated soft zones near the tip of the blade to transfer high tightening or loosening forces without losing contact with the screw. The precision zone directly above the blade provides a better feel for the rotation angle during fine adjustment work. The Wera Black Point tip and a refined hardening process guarantee a long service life and increased corrosion protection.

Lasertip

Wera Lasertip screwdrivers have been microscopically roughened by a laser. This rough surface literally “bites” into the head of the screw. Accidental slipping becomes a thing of the past.

Low-temperature Impact Strength

VDE tools are often used under extreme conditions, such as very low temperatures. Safety must be guaranteed even under these conditions. The plastics used for the handle of Wera VDE screwdrivers are guaranteed to meet the more stringent test requirements for low-temperature impact strength at -40 °C.

Multi-component Screwdriver Handle

The Kraftform handle has been designed to fit snugly in your hand, making blisters and calluses a thing of the past even after long-term use. The hard materials used for the handle promote fast grip adjustments and prevent the skin from sticking to the handle. The softer, anti-slip zones facilitate zero-loss transfer of high forces. This is an unbeatable combination! Work is done with a flick of the wrist!

Wera ABC

Rapidaptor

Wera developed the Rapidaptor that allows you to change bits quickly with just one hand and without extra tools.

Rapid-in and self-lock

The bit can be pushed into the adaptor without moving the sleeve. The lock is activated automatically as soon as the bit is applied to the screw. Bits are held securely and wobble-free.

Rapid-out

Simply push the sleeve forward to change the bit. The spring mechanism lifts the bit off the magnet and unlocks the tool. The bit can be easily removed. The rapid-out function makes it easy to remove even the smallest bits without extra tools.

Rapid-spin

The free-spinning outer sleeve stabilises battery or mains-powered tools during the screwdriving process. This makes it easier to apply the tool to the screw and prevents slipping.

Chuck-all

The Rapidaptor quick-release chucks hold ¼" DIN ISO 1173 C 6,3 and E 6,3 as well as Wera series 1 and 4 bits.

Single-hand function

Every function of the Rapidaptor quick-release chuck, such as inserting or releasing bits, can be carried out with one hand. This is faster, more economical and more ergonomic. There are no unnecessary manoeuvres.

Rapidaptor with ring magnet

The floating, free-spinning magnetic sleeve holds even large and heavy screws very securely for fast application, eliminating the need to hold the screw, which can be dangerous and painful. Perfect for overhead work.

SPKL L-keys

L-keys with a rubber sleeve (SPKL) are made from easy-to-grip round bars. The sleeve ensures comfortable and safe working even at low temperatures. High corrosion protection.

Stainless Steel Tools

Wera Stainless tools are made from 100 % stainless steel. Their wear debris consists of rustproof stainless steel particles, which prevents unsightly extraneous rust. Wera stainless steel tools are vacuum ice-hardened to give them the necessary hardness and rigidity for industrial applications.

Take it easy Tool Finder

"Take it easy" tool finder with colour coding according to sizes – for simple and rapid accessing of the required tool.

Titanium nitride coated bits

Industrial applications are subject to permanent stresses that place high demands on the durability of the tool. Bits for these applications are coated with extremely hard titanium nitride. This abrasion-proof coating provides the necessary hardness that is required on a mass production line.

TORQ-SET® Mplus

Wera developed the Mplus profile with stronger flanks compared with tools with a conventional TORQ-SET® profile. This results in approximately 70 % extra torsional strength and greatly extends the service life of Wera Mplus tools.

TORQUE-indicators

Wera TORQUE-indicators have been factory pre-set to TORQUE values recommended by leading carbide tool manufacturers. Tightening values are precisely related to the size of the TORX®, TORX PLUS® or hexagon socket screw. TORQUE-indicators ensure safe and easily loosened screw connections.

TORQUE Screwdrivers

Adjustable TORQUE screwdrivers:

TORQUE can be set to the required scale value by hand without special tools.

Pre-set adjustable TORQUE screwdrivers:

With pre-set TORQUE, adjustable within a defined range.

Torsion bits

By diverting TORQUE peaks into the Torsion zone of the bit, premature wear and tear is avoided and dramatically improved service life is achieved.

TORX® B0 with borehole

TORX® tools with a borehole prevent the unauthorised unfastening of safety screws. The screws contain a pin that protrudes into the drive profile so that "normal" TORX® tools cannot be used. This pin fits into the borehole of TORX® B0 tools allowing safety screws to be unfastened.

TORX® with holding function (HF)

The optimised profile wedges the screw to the tool. This is very important in situations where a magnetic screw holder cannot or must not be used (for instance, jobs involving power tools where metal filings attracted by a magnet could affect the screwdriving process, or jobs requiring wedging forces and stainless steel tools, which are non-magnetic because of the nature of the material). The wedging effect can be guaranteed only for tools made to Acument Global Technologies Inc. specifications.

TORX® with pin

The protruding pin that fits into the borehole of the screw makes it easier to centre the tool in the screw recess.

TORX® Wedge

The conical TORX® profile provides a better fit in the screw. Combined with a great recess depth this produces a pinch effect.

TORX PLUS®

Compared with the "normal", round TORX® profile the elliptical profile of TORX PLUS® tools makes it possible to increase the size of the 6 flanks that transfer TORQUE between the tool and the screw. The force applied by the user is distributed across a larger surface area allowing more TORQUE to be transferred and extending the service life of both the screw and the tool.

TORX PLUS® IPR

A 5-flank TORX PLUS® profile with a borehole. This drive geometry has only five flanks instead of the usual six and a borehole to protect safety screws against unauthorised unfastening. The screws cannot be turned with conventional, widely available tools.

Tough absorbing bits (Z)

Tough absorbing bits for hard materials, e.g. sheet steel or metal. Here the screw initially turns smoothly inside the defined thread. As soon as the head of the screw touches the surface of the material large amounts of peak TORQUE are generated that affects both the screw and the tool. Bits that are too hard are likely to break under these conditions.

Two-component clip for L-keys

The durable clip material ensures that L-keys are securely fixed and easy to remove. Abrasion resistant markings help you find the right size tool straight away.

Wrenches, Joker

The Joker's holding function means that nuts and bolts can be held in the jaw and easily positioned where they are needed. Fastening on to the thread can then be done quickly and safely, thanks to the innovative special stop-plate which holds the fastener. No more time-wasting searches for dropped nuts and bolts!

Zyklop ratchets

- Zyklop Speed – A really fast mover.
- Zyklop Hybrid – Combines robustness, slim design, and little weight.
- Zyklop Metal – Extremely slim. Long leverage.
- Zyklop Mini – Rapid fastening even in confined working situations.
- Zyklop ratchet VDE – Insulated and 100% individually tested Zyklop VDE ratchet for safe working up to 1,000 volts.

Zyklop Mini 1

The strong ¼" Bit Ratchet that can withstand at least 65 Nm. Suitable for bits directly driven and sockets (using adaptor). Fine tooth mechanism with 60 teeth, simple switching between left/right operations. Ideal for very confined spaces, where conventional screwdrivers are just too big. Drop-forged full steel design.

Zyklop Mini 2

The Zyklop Mini 2 is suitable for the direct attachment of the special Wera Zyklop sockets 8790 FA. These sockets feature a very low height, ideal for confined working spaces.

TORQUE Test Values



Slotted Tools

Drives: DIN ISO 2380, VSM 35601.
TORQUE values evaluated in test gages according to DIN ISO 2380 on TORQUE testing equipment.

a x b mm	TORQUE in Nm (min)	
	handuse	poweruse
0,3 x 2,0	0,18	0,20
0,4 x 2,0	0,30	0,35
0,4 x 2,5	0,40	0,45
0,5 x 3,0	0,70	0,80
0,5 x 3,5	0,90	0,98
0,6 x 3,5	1,30	1,40
0,6 x 4,0	1,40	1,61
0,6 x 4,5	-	1,80
0,8 x 4,0	2,60	2,90
0,8 x 4,5	2,88	
0,8 x 5,0	3,20	3,58
0,8 x 5,5	3,50	3,90
1,0 x 5,5	5,50	6,20
1,0 x 6,5	6,50	7,28
1,0 x 7,0	7,0	7,80
1,2 x 6,5	9,40	10,50
1,2 x 7,0	10,0	11,28
1,2 x 8,0	11,5	12,90
1,4 x 9,0	17,6	19,70
1,5 x 13	29	32
1,6 x 8,0	20,5	22,9
1,6 x 9,0	23	25
1,6 x 10	25,6	28,7
2,0 x 12	48,0	53
2,0 x 13	52	58
2,5 x 14	87	98
2,5 x 16	100	112
3,0 x 18	162	181

Important device:

After TORQUE testing with the minimum value, screwdrivers shall not show any deformation or injuries at the tip.



Hexagon Tools

Drives: DIN ISO 2936. TORQUE values evaluated in test gages according to DIN ISO 2936 on TORQUE testing equipment.

SW (mm)	TORQUE in Nm (min)
0,7	0,08
0,9	0,18
1,3	0,53
1,5	0,82
2,0	1,9
2,5	3,8
3	6,6
3,5	11
4	16
4,5	24
5	30
6	52
7	78
8	120
9	180
10	220
11	295
12	370
13	480
14	590
17	1000
19	1000
22	1000
24	1000
27	1000



PH and PZ Tools

Drives: DIN 5260, ISO 8764 and SMS-SS 1687.

TORQUE values evaluated in test gages according to DIN 5261, ISO 8764 on TORQUE testing equipment.

	TORQUE in Nm (min)	
	handuse	poweruse
0	1,0	1,0
1	3,5	3,9
2	8,2	10,3
3	19,5	32,0
4	38,0	88,7



Tools with TORX® and TORX PLUS® drive

TORQUE values evaluated with testing gages of Acument Global Technologies Inc., licensor of TORX® and TORX PLUS®.

	TORQUE in Nm (min.)					
	TORX®			TORX PLUS®		
	Bit	Resis-Bit	Screw-driver	Bit	Resis-Bit	Screw-driver
1	0,10	-	0,08	0,11		
2	0,14	-	0,12	0,16		
3	0,25	-	0,21	0,28		
4	0,37	-	0,31	0,44		
5	0,51	-	0,43	0,61		
6	0,91	-	0,75	1,11		0,92
7	1,7	1,4	1,4	2,10		1,68
8	2,6	2,2	2,2	3,21	2,5	2,79
9	3,4	2,9	2,8	4,19	3,3	3,49
10	4,5	3,8	3,7	5,42	4,3	4,47
15	7,7	6,5	6,4	9,62	7,3	8,06
20	12,7	10,8	10,5	16,15	11,9	13,41
25	19,0	16,1	15,9	23,50	17,4	19,58
27	26,9	22,9	22,5	34,62	25,1	28,95
30	37,4	31,8	31,1	47,18	33,5	39,34
40	65,1	55,3	54,1	82,08	59,4	68,40
45	104	88	86	137,38	97,3	114,44
50	159	135	132	194,54	152,4	162,14
55	257	218	218	352,10	291,5	299,25
60	445	379	379	566,11	483,0	481,24
70	701	596	600	910,40	713,3	773,91



Tools with TORQ-SET® drive

TORQUE values evaluated with testing gages of Phillips Screw Company, licensor of TORQ-SET®, on TORQUE testing equipment.

	TORQUE in Nm (min)	
	Bits	Screw-drivers
2	1,1	1,1
3	1,7	1,7
4	2,8	2,8
5	4,0	4,0
6	5,1	5,1
8	8,5	8,5
10	11,3	11,3
1/4"	28	17
5/16"	56	28
3/8"	102	62
7/16"	147	
1/2"	249	
9/16"	271	
5/8"	339	

Dimensions Of Profiles

TORX® Recess Screws

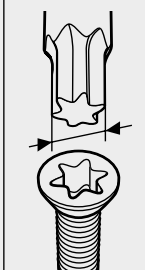

	A Ref. (mm)
TX 1	0,84
TX 2	0,94
TX 3	1,12
TX 4	1,30
TX 5	1,37
TX 6	1,65
TX 7	1,97
TX 8	2,30
TX 9	2,48
TX 10	2,72
TX 15	3,26
TX 20	3,84
TX 25	4,40
TX 27	4,96
TX 30	5,49
TX 40	6,60
TX 45	7,77
TX 50	8,79
TX 55	11,17
TX 60	13,20
TX 70	15,49

TORX PLUS® Recess Screws

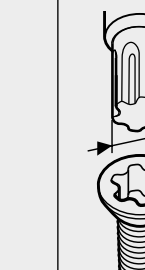

	A Ref. (mm)
1 IP	0,84
2 IP	0,95
3 IP	1,13
4 IP	1,29
5 IP	1,41
6 IP	1,69
7 IP	1,97
8 IP	2,29
9 IP	2,48
10 IP	2,72
15 IP	3,25
20 IP	3,84
25 IP	4,39
27 IP	4,95
30 IP	5,49
40 IP	6,60
45 IP	7,77
50 IP	8,79
55 IP	11,16
60 IP	13,20
70 IP	15,48

TORQ-SET® Recess Screws

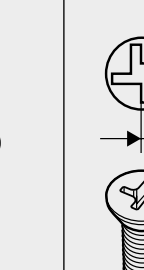

	A Ref. (mm)
0	0,43
1	0,43
2	0,43
3	0,48
4	0,56
5	0,63
6	0,71
8	0,84
10	0,96
1/4"	1,27
5/16"	1,60
3/8"	1,90
7/16"	2,23
1/2"	2,54

TRI-WING® Recess Screws

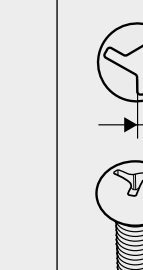

	A Ref. (mm)
0	0,45
1	0,57
2	0,75
3	0,95
4	1,08
5	1,23
6	1,54
7	1,87
8	2,17
9	2,48
10	2,78

XZN Recess Screws

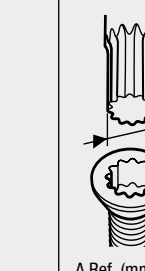

	A Ref. (mm)
M 4	3,83
M 5	4,80
M 6	6,00
M 8	7,20
M 10	9,60
M 12	11,41
M 14	13,22
M 16	15,63
M 18	16,85
M 20	19,25

Square Recess Screws

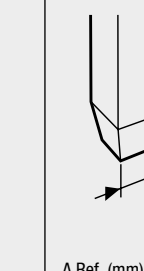

	A Ref. (mm)	A Ref. (mm)
00	1,27	1,4
0	1,78	2
1	2,31	2,5
2	2,85	3,1
3	3,37	3,7
4	4,84	5,1

Spanner Recess Screws

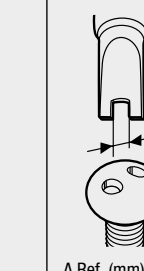

	A Ref. (mm)
4	1,52
6	2,41
8	2,79
10	3,30

TORQUE Conversion Table

Conversion								
Units	SI Units			Metric scale		USA GB scale		
	cNm	dNm	Nm	cmkg	mkg	ft.lb	in.lb	in.oz
1 cNm =	1	0,1	0,01	0,1020	0,0010	0,0074	0,0885	1,4161
1 dNm =	10	1	0,1	1,0197	0,0102	0,0738	0,8851	14,1612
1 Nm =	100	10	1	10,1972	0,1020	0,7376	8,8508	141,6123
1 cmkg =	9,8067	0,9807	0,0981	1	0,0100	0,0723	0,8680	13,8874
1 mkg =	980,6650	98,0665	9,8067	100	1	7,2330	86,7964	1388,7422
1 ft.lb =	135,5818	13,5581	1,3558	13,8255	0,1383	1	12	192
1 in.lb =	11,2985	1,1298	0,1130	1,1521	0,0115	0,0833	1	16
1 in. oz =	0,7062	0,0706	0,0071	0,0720	0,0007	0,0052	0,0625	1

Example 1
 1 Nm = 0,102 mkg
 17,4 Nm = 17,4 x 0,102 mkg
 17,4 Nm = 1,775 mkg

Example 2
 1 mkg = 9,8067 Nm
 12,5 mkg = 12,5 x 9,8067 Nm
 12,5 mkg = 122,58 Nm

Conversion Nm in mkg **1 Nm = 0,10197 mkg**

Nm	0	1	2	3	4	5	6	7	8	9
0	0,00	0,10	0,20	0,31	0,41	0,51	0,61	0,71	0,82	0,92
10	1,02	1,12	1,22	1,33	1,43	1,53	1,63	1,73	1,84	1,94
20	2,04	2,14	2,24	2,35	2,45	2,55	2,65	2,75	2,86	2,96
30	3,06	3,16	3,26	3,37	3,47	3,57	3,67	3,77	3,87	3,98
40	4,08	4,18	4,28	4,38	4,49	4,59	4,69	4,79	4,89	5,00
50	5,10	5,20	5,30	5,40	5,51	5,61	5,71	5,81	5,91	6,02
60	6,12	6,22	6,32	6,42	6,53	6,63	6,73	6,83	6,93	7,04
70	7,14	7,24	7,34	7,44	7,55	7,65	7,75	7,85	7,95	8,06
80	8,16	8,26	8,36	8,46	8,57	8,67	8,77	8,87	8,97	9,08
90	9,18	9,28	9,38	9,48	9,59	9,69	9,79	9,89	9,99	10,10
100	10,20	10,30	10,40	10,50	10,60	10,71	10,81	10,91	11,01	11,11

Conversion mkg in Nm **1 mkg = 9,80665 Nm**

mkg	0	1	2	3	4	5	6	7	8	9
0	0,00	9,81	19,61	29,42	39,23	49,03	58,84	68,65	78,45	88,26
10	98,07	107,87	117,68	127,49	137,29	147,10	156,91	166,71	176,52	186,33
20	196,13	205,94	215,75	225,55	235,36	245,17	254,97	264,78	274,59	284,39
30	294,20	304,01	313,81	323,62	333,43	343,23	353,04	362,85	372,65	382,46
40	392,27	402,07	411,88	421,69	431,49	441,30	451,11	460,91	470,72	480,53
50	490,33	500,14	509,95	519,75	529,56	539,37	549,17	558,98	568,79	578,59
60	588,40	598,21	608,01	617,82	627,63	637,43	647,24	657,05	666,85	676,66
70	686,47	696,27	706,08	715,89	725,69	735,50	745,31	755,11	764,92	774,73
80	784,53	794,34	804,15	813,95	823,76	833,57	843,37	853,18	862,99	872,79
90	882,60	892,41	902,21	912,02	921,83	931,63	941,44	951,25	961,05	970,86
100	980,67	990,47	1000,28	1010,08	1019,89	1029,70	1039,50	1049,31	1059,12	1068,92

Conversion Nm in ft.lb **1 Nm = 0,73756 ft.lb**

Nm	0	1	2	3	4	5	6	7	8	9
0	0,00	0,74	1,48	2,21	2,95	3,69	4,43	5,16	5,90	6,64
10	7,38	8,11	8,85	9,59	10,33	11,06	11,80	12,54	13,28	14,01
20	14,75	15,49	16,23	16,96	17,70	18,44	19,18	19,91	20,65	21,39
30	22,13	22,86	23,60	24,34	25,08	25,81	26,55	27,29	28,03	28,76
40	29,50	30,24	30,98	31,72	32,45	33,19	33,93	34,67	35,40	36,14
50	36,88	37,62	38,35	39,09	39,83	40,57	41,30	42,04	42,78	43,52
60	44,25	44,99	45,73	46,47	47,20	47,94	48,68	49,42	50,15	50,89
70	51,63	52,37	53,10	53,84	54,58	55,32	56,05	56,79	57,53	58,27
80	59,00	59,74	60,48	61,22	61,96	62,69	63,43	64,17	64,91	65,64
90	66,38	67,12	67,86	68,59	69,33	70,07	70,81	71,54	72,28	73,02
100	73,76	74,49	75,23	75,97	76,71	77,44	78,18	78,92	79,66	80,39

Conversion ft.lb in Nm **1 ft.lb = 1,35581 Nm**

ft.lb	0	1	2	3	4	5	6	7	8	9
0	0,00	1,36	2,71	4,07	5,42	6,78	8,13	9,49	10,85	12,20
10	13,56	14,91	16,27	17,63	18,98	20,34	21,69	23,05	24,40	25,76
20	27,12	28,47	29,83	31,18	32,54	33,90	35,25	36,61	37,96	39,32
30	40,67	42,03	43,39	44,74	46,10	47,45	48,81	50,16	51,52	52,88
40	54,23	55,59	56,94	58,30	59,66	61,01	62,37	63,72	65,08	66,43
50	67,79	69,15	70,50	71,86	73,21	74,57	75,93	77,28	78,64	79,99
60	81,35	82,70	84,06	85,42	86,77	88,13	89,48	90,84	92,20	93,55
70	94,91	96,26	97,62	98,97	100,33	101,69	103,04	104,40	105,75	107,11
80	108,46	109,82	111,18	112,53	113,89	115,24	116,60	117,96	119,31	120,67
90	122,02	123,38	124,73	126,09	127,45	128,80	130,16	131,51	132,87	134,23
100	135,58	136,94	138,29	139,65	141,00	142,36	143,72	145,07	146,43	147,78

Conversion Nm in in.lb **1 Nm = 8,85077 in.lb**

Nm	0	1	2	3	4	5	6	7	8	9
0	0,00	8,85	17,70	26,55	35,40	44,25	53,10	61,96	70,81	79,66
10	88,51	97,36	106,21	115,06	123,91	132,76	141,61	150,46	159,31	168,16
20	177,02	185,87	194,72	203,57	212,42	221,27	230,12	238,97	247,82	256,67
30	265,52	274,37	283,22	292,08	300,93	309,78	318,63	327,48	336,33	345,18
40	354,03	362,88	371,73	380,58	389,43	398,28	407,14	415,99	424,84	433,69
50	442,54	451,39	460,24	469,09	477,94	486,79	495,64	504,49	513,34	522,20
60	531,05	539,90	548,75	557,60	566,45	575,30	584,15	593,00	601,85	610,70
70	619,55	628,40	637,26	646,11	654,96	663,81	672,66	681,51	690,36	699,21
80	708,06	716,91	725,76	734,61	743,46	752,32	761,17	770,02	778,87	787,72
90	796,57	805,42	814,27	823,12	831,97	840,82	849,67	858,52	867,38	876,23
100	885,08	893,93	902,78	911,63	920,48	929,33	938,18	947,03	955,88	964,73

Conversion in.lb in Nm **1 in.lb = 0,11298 Nm**

in.lb	0	1	2	3	4	5	6	7	8	9
0	0,00	0,11	0,23	0,34	0,45	0,56	0,68	0,79	0,90	1,02
10	1,13	1,24	1,36	1,47	1,58	1,69	1,81	1,92	2,03	2,15
20	2,26	2,37	2,49	2,60	2,71	2,82	2,94	3,05	3,16	3,28
30	3,39	3,50	3,62	3,73	3,84	3,95	4,07	4,18	4,29	4,41
40	4,52	4,63	4,75	4,86	4,97	5,08	5,20	5,31	5,42	5,54
50	5,65	5,76	5,87	5,99	6,10	6,21	6,33	6,44	6,55	6,67
60	6,78	6,89	7,00	7,12	7,23	7,34	7,46	7,57	7,68	7,80
70	7,91	8,02	8,13	8,25	8,36	8,47	8,59	8,70	8,81	8,93
80	9,04	9,15	9,26	9,38	9,49	9,60	9,72	9,83	9,94	10,06
90	10,17	10,28	10,39	10,51	10,62	10,73	10,85	10,96	11,07	11,19
100	11,30	11,41	11,52	11,64	11,75	11,86	11,98	12,09	12,20	12,31

Conversion Of Inches To Millimeters

Inches		0	1	2	3	4	5	6	7	8	9
			25.400	50.800	76.200	101.600	127.000	152.400	177.800	203.200	228.600
1/64	0.015625	0.397	25.797	51.197	76.597	101.997	127.397	152.797	178.197	203.597	228.997
1/32	0.03125	0.794	26.194	51.594	76.994	102.394	127.794	153.194	178.594	203.994	229.394
3/64	0.046875	1.191	26.591	51.991	77.391	102.791	128.191	153.591	178.991	204.391	229.791
1/16	0.0625	1.588	26.988	52.388	77.788	103.188	128.588	153.988	179.388	204.788	230.188
5/64	0.078125	1.984	27.384	52.784	78.184	103.584	128.984	154.384	179.784	205.184	230.584
3/32	0.09375	2.381	27.781	53.181	78.581	103.981	129.381	154.781	180.181	205.581	230.981
7/64	0.109375	2.778	28.178	53.578	78.978	104.378	129.778	155.178	180.578	205.978	231.378
1/8	0.125	3.175	28.575	53.975	79.375	104.775	130.175	155.575	180.975	206.375	231.775
9/64	0.140625	3.572	28.972	54.372	79.772	105.172	130.572	155.972	181.372	206.772	232.172
5/32	0.15625	3.969	29.369	54.769	80.169	105.569	130.969	156.369	181.769	207.169	232.569
11/64	0.171875	4.366	29.766	55.166	80.566	105.966	131.366	156.766	182.166	207.566	232.966
3/16	0.1875	4.762	30.162	55.562	80.962	106.362	131.762	157.162	182.562	207.962	233.362
13/64	0.203125	5.159	30.559	55.959	81.359	106.759	132.159	157.559	182.959	208.359	233.759
7/32	0.21875	5.556	30.956	56.356	81.756	107.156	132.556	157.956	183.356	208.756	234.156
15/64	0.234375	5.953	31.353	56.753	82.153	107.553	132.953	158.353	183.753	209.153	234.553
1/4	0.25	6.350	31.750	57.150	82.550	107.950	133.350	158.750	184.150	209.550	234.950
17/64	0.265625	6.747	32.147	57.547	82.947	108.347	133.747	159.147	184.547	209.947	235.347
9/32	0.28125	7.144	32.544	57.944	83.344	108.744	134.144	159.544	184.944	210.344	235.744
19/64	0.296875	7.541	32.941	58.341	83.741	109.141	134.541	159.941	185.341	210.741	236.141
5/16	0.3125	7.938	33.338	58.738	84.138	109.538	134.938	160.338	185.738	211.138	236.538
21/64	0.328125	8.334	33.734	59.134	84.534	109.934	135.334	160.734	186.134	211.534	236.934
11/32	0.34375	8.731	34.131	59.531	84.931	110.331	135.731	161.131	186.531	211.931	237.331
23/64	0.359375	9.128	34.528	59.928	85.328	110.728	136.128	161.528	186.928	212.328	237.728
3/8	0.375	9.525	34.925	60.325	85.725	111.125	136.525	161.925	187.325	212.725	238.125
25/64	0.390625	9.922	35.322	60.722	86.122	111.522	136.922	162.322	187.722	213.122	238.522
13/32	0.40625	10.319	35.719	61.119	86.519	111.919	137.319	162.719	188.119	213.519	238.919
27/64	0.421875	10.716	36.116	61.516	86.916	112.316	137.716	163.116	188.516	213.916	239.316
7/16	0.4375	11.112	36.512	61.912	87.312	112.712	138.112	163.512	188.912	214.312	239.712
29/64	0.453125	11.509	36.909	62.309	87.709	113.109	138.509	163.909	189.309	214.709	240.109
15/32	0.46875	11.906	37.306	62.706	88.106	113.506	138.906	164.306	189.706	215.106	240.506
31/64	0.484375	12.303	37.703	63.103	88.503	113.903	139.303	164.703	190.103	215.503	240.903
1/2	0.5	12.700	38.100	63.500	88.900	114.300	139.700	165.100	190.500	215.900	241.300
33/64	0.515625	13.097	38.497	63.897	89.297	114.697	140.097	165.497	190.897	216.297	241.697
17/32	0.53125	13.494	38.894	64.294	89.694	115.094	140.494	165.894	191.294	216.694	242.094
35/64	0.546875	13.891	39.291	64.691	90.091	115.491	140.891	166.291	191.691	217.091	242.491
9/16	0.5625	14.288	39.688	65.088	90.488	115.888	141.288	166.688	192.088	217.488	242.888
37/64	0.578125	14.684	40.084	65.484	90.884	116.284	141.684	167.084	192.484	217.884	243.284
19/32	0.59375	15.081	40.481	65.881	91.281	116.681	142.081	167.481	192.881	218.281	243.681
39/64	0.609375	15.478	40.878	66.278	91.678	117.078	142.478	167.878	193.278	218.678	244.078
5/8	0.625	15.875	41.275	66.675	92.075	117.475	142.875	168.275	193.675	219.075	244.475
41/64	0.640625	16.272	41.672	67.072	92.472	117.872	143.272	168.672	194.072	219.472	244.872
21/32	0.65625	16.669	42.069	67.469	92.869	118.269	143.669	169.069	194.469	219.869	245.269
43/64	0.671875	17.066	42.466	67.866	93.266	118.666	144.066	169.466	194.866	220.266	245.666
11/16	0.6875	17.462	42.862	68.262	93.662	119.062	144.462	169.862	195.262	220.662	246.062
45/64	0.703125	17.859	43.259	68.659	94.059	119.459	144.859	170.259	195.659	221.059	246.459
23/32	0.71875	18.256	43.656	69.056	94.456	119.856	145.256	170.656	196.056	221.456	246.856
47/64	0.734375	18.653	44.053	69.453	94.853	120.253	145.653	171.053	196.453	221.853	247.253
3/4	0.75	19.050	44.450	69.850	95.250	120.650	146.050	171.450	196.850	222.250	247.650
49/64	0.765625	19.447	44.847	70.247	95.647	121.047	146.447	171.847	197.247	222.647	248.047
25/32	0.78125	19.844	45.244	70.644	96.044	121.444	146.844	172.244	197.644	223.044	248.444
51/64	0.796875	20.241	45.641	71.041	96.441	121.841	147.241	172.641	198.041	223.441	248.841
13/16	0.8125	20.638	46.038	71.438	96.838	122.238	147.638	173.038	198.438	223.838	249.238
53/64	0.828125	21.034	46.434	71.834	97.234	122.634	148.034	173.434	198.834	224.234	249.634
27/32	0.84375	21.431	46.831	72.231	97.631	123.031	148.431	173.831	199.231	224.631	250.031
55/64	0.859375	21.828	47.228	72.628	98.028	123.428	148.828	174.228	199.628	225.028	250.428
7/8	0.875	22.225	47.625	73.025	98.425	123.825	149.225	174.625	200.025	225.425	250.825
57/64	0.890625	22.622	48.022	73.422	98.822	124.222	149.622	175.022	200.422	225.822	251.222
29/32	0.90625	23.019	48.419	73.819	99.219	124.619	150.019	175.419	200.819	226.219	251.619
59/64	0.921875	23.416	48.816	74.216	99.616	125.016	150.416	175.816	201.216	226.616	252.016
15/16	0.9375	23.812	49.212	74.612	100.012	125.412	150.812	176.212	201.612	227.012	252.412
61/64	0.953125	24.209	49.609	75.009	100.409	125.809	151.209	176.609	202.009	227.409	252.809
31/32	0.96875	24.606	50.006	75.406	100.806	126.206	151.606	177.006	202.406	227.806	253.206
63/64	0.984375	25.003	50.403	75.803	101.203	126.603	152.003	177.403	202.803	228.203	253.603

Values in mm

Code No.	Page	Code No.	Page	Code No.	Page	Code No.	Page
05 003521 001	156	05 003608 001	202	05 003726 001	156	05 003852 001	204
05 003522 001	156	05 003609 001	202	05 003727 001	156	05 003853 001	204
05 003523 001	156	05 003610 001	202	05 003728 001	156	05 003854 001	204
05 003524 001	166	05 003611 001	202	05 003729 001	156	05 003855 001	204
05 003525 001	167	05 003612 001	202	05 003730 001	202	05 003856 001	204
05 003526 001	166	05 003613 001	202	05 003731 001	202	05 003857 001	204
05 003527 001	169	05 003614 001	202	05 003732 001	202	05 003858 001	204
05 003528 001	169	05 003615 001	202	05 003733 001	202	05 003880 001	157
05 003529 001	169	05 003616 001	202	05 003734 001	202	05 003881 001	162
05 003530 001	166	05 003617 001	202	05 003735 001	202	05 003882 001	161
05 003531 001	166	05 003618 001	202	05 003736 001	202	05 003883 001	159
05 003533 001	148	05 003619 001	202	05 003737 001	202	05 003884 001	160
05 003535 001	148	05 003620 001	202	05 003738 001	202	05 003890 001	163
05 003550 001	174	05 003621 001	202	05 003739 001	202	05 003891 001	164
05 003551 001	180	05 003622 001	202	05 003740 001	180	05 003970 001	181
05 003552 001	180	05 003623 001	202	05 003741 001	180	05 003971 001	184
05 003553 001	180	05 003624 001	202	05 003742 001	180	05 003972 001	182
05 003554 001	180	05 003625 001	202	05 003743 001	180	05 003973 001	181
05 003555 001	180	05 003626 001	202	05 003744 001	180	05 003974 001	184
05 003556 001	180	05 003627 001	202	05 003745 001	180	05 003980 001	185
05 003557 001	180	05 003628 001	202	05 003746 001	180	05 003981 001	185
05 003558 001	180	05 003629 001	202	05 003747 001	180	05 003990 001	114
05 003559 001	180	05 003630 001	202	05 003748 001	180	05 004003 001	153
05 003560 001	180	05 003631 001	202	05 003749 001	180	05 004004 001	155
05 003561 001	180	05 003632 001	202	05 003750 001	180	05 004016 001	144
05 003562 001	180	05 003633 001	202	05 003751 001	180	05 004017 001	152
05 003563 001	180	05 003634 001	202	05 003752 001	180	05 004018 001	154
05 003564 001	180	05 003635 001	202	05 003753 001	180	05 004019 001	145
05 003565 001	180	05 003636 001	209	05 003755 001	144	05 004020 001	152
05 003566 001	180	05 003637 001	208	05 003756 001	155	05 004021 001	154
05 003567 001	180	05 003638 001	208	05 003760 001	228	05 004033 001	177
05 003568 001	180	05 003639 001	209	05 003765 001	228	05 004034 001	179
05 003569 001	180	05 003640 001	209	05 003780 001	196	05 004046 001	172
05 003570 001	180	05 003641 001	209	05 003781 001	196	05 004047 001	176
05 003571 001	180	05 003642 001	208	05 003785 001	179	05 004048 001	178
05 003572 001	180	05 003643 001	208	05 003820 001	206	05 004049 001	172
05 003573 001	180	05 003645 001	191	05 003821 001	206	05 004050 001	176
05 003574 001	180	05 003647 001	192	05 003822 001	206	05 004051 001	178
05 003575 001	180	05 003660 001	222	05 003823 001	206	05 004063 001	199
05 003576 001	180	05 003665 001	223	05 003824 001	206	05 004064 001	201
05 003577 001	180	05 003666 001	223	05 003825 001	206	05 004076 001	190
05 003578 001	180	05 003667 001	223	05 003826 001	206	05 004077 001	198
05 003579 001	180	05 003668 001	223	05 003827 001	206	05 004078 001	200
05 003580 001	180	05 003669 001	223	05 003828 001	206	05 004079 001	190
05 003581 001	187	05 003670 001	223	05 003829 001	206	05 004080 001	198
05 003582 001	186	05 003675 001	223	05 003830 001	204	05 004081 001	200
05 003583 001	186	05 003684 001	223	05 003831 001	204	05 004090 001	194
05 003584 001	187	05 003685 001	223	05 003832 001	204	05 004095 001	194
05 003585 001	187	05 003690 001	223	05 003833 001	204	05 004201 001	205
05 003590 001	186	05 003692 001	212	05 003834 001	204	05 004202 001	204
05 003591 001	186	05 003695 001	212	05 003835 001	204	05 004203 001	203
05 003592 001	186	05 003696 001	213	05 003836 001	204	05 004210 001	206
05 003594 001	173	05 003697 001	213	05 003837 001	204	05 004211 001	204
05 003596 001	174	05 003717 001	156	05 003838 001	204	05 004212 001	205
05 003600 001	192	05 003718 001	156	05 003840 001	206	05 004310 001	105
05 003601 001	202	05 003719 001	156	05 003841 001	206	05 004313 001	46
05 003602 001	202	05 003720 001	156	05 003842 001	206	05 004350 001	300
05 003603 001	202	05 003721 001	156	05 003843 001	206	05 004351 001	300
05 003604 001	202	05 003722 001	156	05 003844 001	206	05 004352 001	300
05 003605 001	202	05 003723 001	156	05 003845 001	206	05 004353 001	300
05 003606 001	202	05 003724 001	156	05 003850 001	204	05 004354 001	301
05 003607 001	202	05 003725 001	156	05 003851 001	204	05 004355 001	301

Code No. Index

Code No.	Page	Code No.	Page	Code No.	Page	Code No.	Page
05 004650	001 99	05 006162	001 96	05 008710	001 36	05 013362	001 76
05 004655	001 99	05 006163	001 96	05 008712	001 36	05 013364	001 76
05 004660	001 99	05 006164	001 96	05 008715	001 36	05 013366	001 76
05 004665	001 99	05 006165	001 96	05 008720	001 36	05 013368	001 76
05 004670	001 99	05 006166	001 96	05 008723	001 36	05 013370	001 76
05 004675	001 99	05 006168	001 96	05 008725	001 36	05 013372	001 76
05 004780	001 100	05 006169	001 99	05 008730	001 36	05 013374	001 76
05 004781	001 100	05 006170	001 99	05 008735	001 36	05 013376	001 76
05 004782	001 100	05 006172	001 99	05 008740	001 36	05 013390	001 77
05 004783	001 100	05 006174	001 99	05 008750	001 36	05 013399	001 77
05 004784	001 100	05 006176	001 99	05 008751	001 36	05 013400	001 77
05 004950	001 126	05 006177	001 99	05 008752	001 36	05 013401	001 77
05 004951	001 126	05 006178	001 99	05 008753	001 36	05 013402	001 77
05 004952	001 126	05 006179	001 99	05 008775	001 44	05 013403	001 77
05 004953	001 126	05 006181	001 99	05 008780	001 44	05 013404	001 77
05 004954	001 126	05 006182	001 99	05 008782	001 44	05 013405	001 77
05 004955	001 126	05 006183	001 99	05 009305	001 37	05 013407	001 77
05 004956	001 126	05 006184	001 99	05 009310	001 37	05 013409	001 77
05 004957	001 126	05 006186	001 99	05 009312	001 37	05 013411	001 77
05 004958	001 126	05 006190	001 98	05 009313	001 37	05 017005	001 28
05 004959	001 126	05 006191	001 98	05 009315	001 37	05 017010	001 28
05 004960	001 126	05 006380	001 97	05 009317	001 37	05 017015	001 28
05 004961	001 126	05 006381	001 97	05 009319	001 37	05 017020	001 28
05 004962	001 126	05 006440	001 94	05 009320	001 37	05 017040	001 28
05 004963	001 126	05 006441	001 94	05 009325	001 37	05 017041	001 28
05 004964	001 128	05 006442	001 94	05 009330	001 44	05 017050	001 29
05 004965	001 128	05 006450	001 96	05 009335	001 44	05 017052	001 29
05 004966	001 126	05 006451	001 96	05 009337	001 44	05 017054	001 29
05 004970	001 129	05 006455	001 98	05 009340	001 37	05 017056	001 29
05 005300	001 100	05 006456	001 98	05 009341	001 37	05 017205	001 257
05 005305	001 100	05 006460	001 97	05 009342	001 37	05 017305	001 257
05 005310	001 100	05 006461	001 97	05 009343	001 37	05 017405	001 257
05 005315	001 100	05 006465	001 98	05 013300	001 76	05 017410	001 257
05 005320	001 100	05 006466	001 98	05 013301	001 76	05 017415	001 257
05 005325	001 100	05 006480	001 104	05 013302	001 76	05 018005	001 60
05 005330	001 100	05 007355	001 35	05 013303	001 76	05 018010	001 60
05 005335	001 100	05 007610	001 34	05 013304	001 76	05 018015	001 60
05 005340	001 100	05 007620	001 34	05 013305	001 76	05 018020	001 60
05 005655	001 101	05 007621	001 34	05 013306	001 76	05 018025	001 60
05 006100	001 94	05 007635	001 34	05 013307	001 76	05 018030	001 60
05 006105	001 94	05 007640	001 34	05 013308	001 76	05 018035	001 60
05 006110	001 94	05 007670	001 34	05 013309	001 76	05 018040	001 60
05 006115	001 94	05 007671	001 34	05 013310	001 76	05 018251	001 60
05 006116	001 94	05 007672	001 34	05 013311	001 76	05 018260	001 28
05 006120	001 94	05 007673	001 34	05 013312	001 76	05 018262	001 28
05 006121	001 94	05 007674	001 34	05 013314	001 76	05 018264	001 28
05 006125	001 94	05 007675	001 34	05 013330	001 76	05 018266	001 28
05 006126	001 94	05 007676	001 34	05 013331	001 76	05 018268	001 28
05 006130	001 94	05 007677	001 34	05 013332	001 76	05 018270	001 28
05 006135	001 94	05 007680	001 48	05 013333	001 76	05 018272	001 28
05 006140	001 94	05 007681	001 48	05 013334	001 76	05 018274	001 28
05 006145	001 102	05 008006	001 34	05 013335	001 76	05 018282	001 30
05 006147	001 102	05 008007	001 34	05 013337	001 76	05 018283	001 30
05 006148	001 103	05 008008	001 34	05 013338	001 76	05 018287	001 31
05 006150	001 95	05 008009	001 34	05 013339	001 76	05 018300	001 28
05 006152	001 95	05 008015	001 34	05 013341	001 76	05 018301	001 28
05 006153	001 95	05 008027	001 34	05 013350	001 76	05 018302	001 28
05 006154	001 95	05 008055	001 34	05 013352	001 76	05 018350	001 60
05 006156	001 95	05 008060	001 34	05 013354	001 76	05 018352	001 60
05 006158	001 95	05 008061	001 34	05 013356	001 76	05 018354	001 60
05 006159	001 95	05 008705	001 36	05 013358	001 76	05 018355	001 60
05 006160	001 96	05 008706	001 36	05 013360	001 76	05 020012	001 229

Code No.	Page	Code No.	Page	Code No.	Page	Code No.	Page
05 020013 001	228	05 021640 001	248	05 022630 001	247	05 022920 001	38
05 020022 001	229	05 021645 001	248	05 022631 001	247	05 022925 001	38
05 020064 001	230	05 021728 001	245	05 022632 001	247	05 022930 001	38
05 020065 001	230	05 021737 001	244	05 022633 001	247	05 022935 001	38
05 020066 001	230	05 021909 001	242	05 022634 001	247	05 023105 001	38
05 020067 001	230	05 022040 001	248	05 022635 001	247	05 023107 001	38
05 020068 001	230	05 022041 001	248	05 022636 001	247	05 023110 001	38
05 020069 001	230	05 022042 001	248	05 022637 001	247	05 023115 001	38
05 020070 001	230	05 022043 001	248	05 022638 001	247	05 023120 001	38
05 020071 001	230	05 022044 001	248	05 022639 001	241	05 023125 001	38
05 020072 001	230	05 022045 001	248	05 022660 001	246	05 023130 001	38
05 020073 001	230	05 022046 001	248	05 022661 001	246	05 023305 001	60
05 020074 001	230	05 022047 001	248	05 022662 001	246	05 023307 001	60
05 020075 001	230	05 022048 001	248	05 022663 001	246	05 023309 001	60
05 020076 001	230	05 022050 001	247	05 022664 001	246	05 024001 001	256
05 020077 001	230	05 022052 001	247	05 022665 001	246	05 024002 001	256
05 020078 001	230	05 022054 001	247	05 022666 001	246	05 024003 001	256
05 020079 001	230	05 022056 001	247	05 022667 001	246	05 024004 001	256
05 020080 001	230	05 022058 001	247	05 022668 001	246	05 024005 001	256
05 020081 001	230	05 022060 001	247	05 022669 001	238	05 024008 001	256
05 020082 001	230	05 022062 001	247	05 022700 001	246	05 024010 001	256
05 020090 001	231	05 022063 001	247	05 022701 001	246	05 024012 001	256
05 020091 001	232	05 022064 001	247	05 022702 001	246	05 024013 001	256
05 020092 001	231	05 022066 001	247	05 022703 001	246	05 024015 001	256
05 020093 001	232	05 022067 001	247	05 022704 001	246	05 024020 001	256
05 020129 001	94	05 022068 001	248	05 022705 001	246	05 024100 001	256
05 020131 001	96	05 022070 001	248	05 022706 001	246	05 024105 001	256
05 020132 001	98	05 022071 001	248	05 022708 001	246	05 024160 001	256
05 020133 001	96	05 022072 001	248	05 022709 001	246	05 024161 001	256
05 020134 001	98	05 022073 001	248	05 022710 001	246	05 024162 001	256
05 021005 001	249	05 022074 001	248	05 022711 001	246	05 024163 001	256
05 021010 001	249	05 022076 001	248	05 022712 001	246	05 024164 001	256
05 021015 001	249	05 022078 001	248	05 022713 001	246	05 024165 001	256
05 021020 001	249	05 022079 001	248	05 022714 001	246	05 024166 001	256
05 021025 001	249	05 022080 001	248	05 022715 001	246	05 024167 001	256
05 021030 001	249	05 022081 001	248	05 022716 001	246	05 024168 001	256
05 021035 001	249	05 022082 001	248	05 022717 001	246	05 024170 001	254
05 021040 001	249	05 022086 001	244	05 022718 001	246	05 024171 001	254
05 021045 001	249	05 022087 001	242	05 022720 001	238	05 024172 001	254
05 021050 001	249	05 022089 001	240	05 022721 001	239	05 024173 001	254
05 021055 001	249	05 022095 001	248	05 022728 001	91	05 024174 001	254
05 021060 001	249	05 022096 001	248	05 022729 001	90	05 024175 001	254
05 021065 001	249	05 022101 001	244	05 022730 001	90	05 024176 001	254
05 021070 001	249	05 022171 001	245	05 022731 001	90	05 024177 001	254
05 021075 001	249	05 022181 001	244	05 022732 001	90	05 024178 001	254
05 021080 001	249	05 022200 001	246	05 022733 001	90	05 024179 001	250
05 021085 001	249	05 022201 001	246	05 022734 001	90	05 024199 001	256
05 021090 001	249	05 022202 001	246	05 022740 001	90	05 024200 001	256
05 021095 001	249	05 022203 001	246	05 022741 001	90	05 024202 001	256
05 021100 001	249	05 022204 001	246	05 022745 001	91	05 024204 001	256
05 021105 001	249	05 022205 001	246	05 022795 001	38	05 024206 001	256
05 021110 001	249	05 022210 001	240	05 022800 001	38	05 024208 001	256
05 021406 001	243	05 022534 001	241	05 022805 001	38	05 024210 001	256
05 021600 001	248	05 022600 001	247	05 022810 001	38	05 024242 001	252
05 021605 001	248	05 022602 001	247	05 022815 001	38	05 024244 001	250
05 021610 001	248	05 022604 001	247	05 022820 001	38	05 024335 001	212
05 021615 001	248	05 022606 001	247	05 022825 001	38	05 024350 001	254
05 021620 001	248	05 022608 001	247	05 022830 001	38	05 024351 001	254
05 021625 001	248	05 022610 001	247	05 022835 001	38	05 024352 001	254
05 021630 001	248	05 022612 001	247	05 022905 001	38	05 024353 001	254
05 021632 001	248	05 022614 001	247	05 022910 001	38	05 024354 001	254
05 021635 001	248	05 022616 001	247	05 022915 001	38	05 024355 001	254

Code No. Index

Code No.	Page	Code No.	Page	Code No.	Page	Code No.	Page
05 024356	001 254	05 027101	001 247	05 028033	001 40	05 029463	001 43
05 024357	001 254	05 027102	001 247	05 028034	001 40	05 029464	001 43
05 024358	001 254	05 027103	001 247	05 028035	001 40	05 029465	001 43
05 024400	001 29	05 027104	001 247	05 028036	001 40	05 029466	001 43
05 024401	001 29	05 027105	001 247	05 028037	001 40	05 029501	001 43
05 024402	001 29	05 027106	001 247	05 028038	001 40	05 029502	001 43
05 024403	001 29	05 027107	001 247	05 028040	001 486	05 029503	001 43
05 024404	001 29	05 027108	001 247	05 028041	001 486	05 029504	001 43
05 024405	001 29	05 027109	001 247	05 028042	001 486	05 029505	001 43
05 024410	001 31	05 027110	001 247	05 028043	001 486	05 029506	001 43
05 024450	001 250	05 027111	001 247	05 028044	001 486	05 029507	001 43
05 024451	001 254	05 027201	001 249	05 028045	001 486	05 029510	001 51
05 024452	001 254	05 027202	001 249	05 028046	001 487	05 030080	001 82
05 024453	001 254	05 027203	001 249	05 028048	001 38	05 030081	001 82
05 024454	001 254	05 027204	001 249	05 028049	001 38	05 030082	001 82
05 024455	001 254	05 027205	001 249	05 028050	001 38	05 030083	001 82
05 024456	001 254	05 027206	001 249	05 028051	001 38	05 030084	001 82
05 024457	001 254	05 027207	001 249	05 028052	001 38	05 030100	001 80
05 024458	001 254	05 027208	001 249	05 028053	001 38	05 030101	001 80
05 024459	001 254	05 027209	001 249	05 028054	001 38	05 030102	001 80
05 024460	001 252	05 027210	001 249	05 028055	001 38	05 030103	001 80
05 024461	001 256	05 027211	001 249	05 028056	001 38	05 030104	001 80
05 024462	001 256	05 027212	001 249	05 028059	001 50	05 030105	001 80
05 024463	001 256	05 027213	001 249	05 028062	001 51	05 030106	001 80
05 024464	001 256	05 027214	001 249	05 028070	001 38	05 030107	001 80
05 024465	001 256	05 027215	001 249	05 028071	001 38	05 030108	001 80
05 024466	001 256	05 027405	001 62	05 028072	001 38	05 030110	001 80
05 024467	001 256	05 027455	001 62	05 028073	001 38	05 030111	001 80
05 024468	001 256	05 027456	001 69	05 028074	001 50	05 030112	001 80
05 024469	001 256	05 027910	001 486	05 028116	001 42	05 030115	001 80
05 024470	001 250	05 027911	001 486	05 028118	001 42	05 030116	001 80
05 024471	001 253	05 027912	001 486	05 028120	001 42	05 030117	001 80
05 024472	001 253	05 027913	001 486	05 028122	001 42	05 030118	001 80
05 024473	001 253	05 027930	001 486	05 028124	001 42	05 030119	001 80
05 024474	001 253	05 027931	001 486	05 028126	001 42	05 030120	001 81
05 024475	001 253	05 027932	001 486	05 028130	001 40	05 030121	001 81
05 024476	001 253	05 027933	001 486	05 028132	001 40	05 030122	001 81
05 024477	001 253	05 027934	001 486	05 028134	001 40	05 030127	001 81
05 024478	001 253	05 027935	001 486	05 028136	001 40	05 030128	001 81
05 024479	001 253	05 027936	001 487	05 028148	001 42	05 030129	001 81
05 024480	001 251	05 027950	001 40	05 028150	001 42	05 030130	001 81
05 024481	001 254	05 027952	001 40	05 028152	001 42	05 030131	001 81
05 024482	001 254	05 027954	001 40	05 028160	001 287	05 030135	001 81
05 024483	001 254	05 027956	001 40	05 028205	001 42	05 030150	001 82
05 024484	001 253	05 027958	001 40	05 028210	001 42	05 030151	001 82
05 024485	001 253	05 028000	001 39	05 028215	001 42	05 030160	001 68
05 024486	001 253	05 028001	001 39	05 028220	001 42	05 030170	001 82
05 024487	001 253	05 028002	001 39	05 028225	001 42	05 030180	001 82
05 024488	001 253	05 028003	001 39	05 028230	001 42	05 030181	001 72
05 024489	001 253	05 028004	001 39	05 029405	001 42	05 030400	001 80
05 026350	001 61	05 028005	001 39	05 029410	001 42	05 030401	001 80
05 026351	001 61	05 028008	001 39	05 029415	001 42	05 030402	001 80
05 026352	001 61	05 028010	001 39	05 029420	001 42	05 030403	001 80
05 026353	001 61	05 028012	001 39	05 029425	001 42	05 030404	001 80
05 026354	001 61	05 028013	001 39	05 029430	001 42	05 030405	001 80
05 026360	001 61	05 028015	001 39	05 029435	001 42	05 030406	001 80
05 026361	001 61	05 028020	001 39	05 029440	001 42	05 030410	001 82
05 026363	001 61	05 028025	001 39	05 029445	001 42	05 030411	001 82
05 026372	001 61	05 028029	001 40	05 029450	001 42	05 030412	001 82
05 026373	001 61	05 028030	001 40	05 029460	001 43	05 030413	001 82
05 026374	001 61	05 028031	001 40	05 029461	001 43	05 030414	001 82
05 026382	001 61	05 028032	001 40	05 029462	001 43	05 030415	001 82

Code No.	Page	Code No.	Page	Code No.	Page	Code No.	Page
05 030416 001	82	05 031602 001	122	05 048680 001	418	05 053475 001	423
05 030417 001	82	05 031603 001	122	05 048681 001	418	05 053480 001	423
05 030418 001	82	05 031604 001	122	05 050005 001	159, 182, 203	05 053485 001	423
05 031400 001	54	05 031605 001	122	05 050205 001	427	05 053520 001	419
05 031401 001	54	05 031610 001	122	05 050210 001	427	05 053522 001	419
05 031402 001	54	05 031611 001	122	05 050215 001	427	05 053560 001	419
05 031403 001	54	05 031613 001	122	05 050220 001	427	05 053870 001	420
05 031405 001	54	05 031615 001	122	05 050510 001	427	05 053872 001	419
05 031406 001	54	05 032001 001	22	05 050650 001	427	05 053920 001	420
05 031408 001	54	05 032002 001	22	05 051005 001	287	05 053923 001	414
05 031409 001	54	05 032003 001	22	05 051010 001	45	05 055950 001	397
05 031411 001	54	05 032004 001	22	05 051011 001	46	05 055951 001	397
05 031412 001	54	05 032005 001	22	05 051016 001	264	05 055952 001	397
05 031413 001	54	05 032006 001	22	05 051019 001	264	05 055953 001	397
05 031416 001	54	05 032007 001	22	05 051021 001	264	05 056005 001	377
05 031420 001	54	05 032020 001	22	05 051023 001	264	05 056007 001	377
05 031421 001	54	05 032021 001	22	05 051024 001	266	05 056010 001	377
05 031422 001	54	05 032022 001	22	05 051025 001	266	05 056015 001	377
05 031424 001	54	05 032023 001	22	05 051030 001	290	05 056020 001	377
05 031425 001	54	05 032030 001	22	05 051031 001	290	05 056025 001	377
05 031426 001	54	05 032031 001	22	05 051040 001	288	05 056030 001	377
05 031427 001	54	05 032032 001	22	05 051041 001	288	05 056037 001	377
05 031440 001	54	05 032033 001	22	05 051042 001	272	05 056040 001	377
05 031441 001	54	05 032050 001	23	05 051043 001	84	05 056045 001	377
05 031442 001	54	05 032051 001	23	05 051045 001	150	05 056064 001	376
05 031444 001	54	05 032052 001	23	05 051105 001	287	05 056066 001	376
05 031445 001	54	05 032053 001	23	05 051106 001	85	05 056068 001	376
05 031447 001	54	05 032054 001	23	05 051205 001	287	05 056155 001	453
05 031460 001	54	05 032055 001	23	05 051272 001	284	05 056157 001	453
05 031461 001	54	05 032056 001	23	05 051273 001	84	05 056158 001	454
05 031463 001	54	05 032057 001	23	05 051274 001	287	05 056159 001	450
05 031466 001	54	05 032058 001	23	05 051276 001	70	05 056161 001	450
05 031500 001	55	05 032060 001	24	05 051461 001	288	05 056163 001	451
05 031501 001	55	05 032061 001	24	05 051462 001	284	05 056164 001	452
05 031502 001	55	05 032063 001	25	05 051464 001	83	05 056168 001	454
05 031503 001	55	05 032070 002	23	05 051465 001	284	05 056172 001	376
05 031504 001	55	05 032071 002	23	05 051482 001	285	05 056174 001	376
05 031505 001	55	05 040001 001	293	05 051500 001	420	05 056176 001	376
05 031506 001	55	05 040030 001	397	05 051501 001	420	05 056200 001	377
05 031507 001	55	05 040031 001	397	05 051502 001	420	05 056203 001	376
05 031508 001	55	05 040032 001	397	05 051610 001	286	05 056210 001	376
05 031509 001	55	05 040033 001	397	05 051615 001	286	05 056220 001	376
05 031510 001	55	05 040034 001	397	05 051620 001	286	05 056225 001	376
05 031511 001	55	05 040040 001	397	05 051835 001	292	05 056233 001	376
05 031512 001	55	05 040041 001	397	05 052490 001	417	05 056240 001	376
05 031551 001	56	05 040042 001	397	05 052500 001	416	05 056285 001	454
05 031552 001	56	05 040043 001	397	05 052502 001	415	05 056291 001	443
05 031553 001	56	05 040045 001	397	05 052503 001	416	05 056294 001	454
05 031554 001	56	05 040046 001	397	05 052504 001	416	05 056295 001	452
05 031575 001	122	05 040047 001	397	05 052505 001	421	05 056296 001	453
05 031576 001	123	05 040048 001	397	05 052575 001	421	05 056303 001	381
05 031580 001	122	05 040049 001	397	05 052625 001	421	05 056305 001	381
05 031581 001	122	05 042605 001	428	05 052655 001	421	05 056310 001	381
05 031582 001	122	05 042655 001	428	05 052725 001	421	05 056315 001	381
05 031583 001	122	05 042665 001	428	05 053175 001	424	05 056320 001	381
05 031584 001	122	05 042705 001	428	05 053275 001	424	05 056325 001	381
05 031585 001	122	05 042715 001	428	05 053425 001	422	05 056330 001	381
05 031587 001	122	05 042750 001	428	05 053455 001	422	05 056332 001	381
05 031588 001	122	05 042755 001	428	05 053457 001	422	05 056335 001	381
05 031589 001	122	05 042760 001	428	05 053458 001	422	05 056340 001	381
05 031600 001	122	05 042765 001	428	05 053459 001	422	05 056341 001	387
05 031601 001	122	05 042768 001	428	05 053460 001	423	05 056342 001	387

Code No. Index

Code No.	Page	Code No.	Page	Code No.	Page	Code No.	Page
05 056343 001	387	05 056714 001	340	05 057434 001	460	05 057672 001	390
05 056344 001	387	05 056720 001	340	05 057441 001	440	05 057675 001	410
05 056345 001	387	05 056722 001	340	05 057442 001	458	05 057676 001	410
05 056346 001	387	05 056724 001	340	05 057450 001	448	05 057680 001	434
05 056350 001	381	05 056805 001	342	05 057455 001	448	05 057682 001	434
05 056352 001	381	05 056810 001	342	05 057460 001	278	05 057683 001	434
05 056354 001	381	05 056812 001	342	05 057505 001	385	05 057684 001	435
05 056356 001	381	05 056815 001	342	05 057510 001	385	05 057688 001	435
05 056358 001	381	05 056820 001	342	05 057515 001	385	05 057690 001	434
05 056368 001	442	05 056825 001	342	05 057520 001	385	05 057691 001	436
05 056374 001	441	05 056835 001	342	05 057525 001	385	05 057692 001	436
05 056375 001	450	05 056910 001	341	05 057530 001	385	05 057693 001	436
05 056376 001	451	05 056915 001	341	05 057550 001	385	05 057694 001	436
05 056400 001	317	05 056925 001	341	05 057551 001	385	05 057695 001	436
05 056402 001	317	05 056937 001	342	05 057552 001	385	05 057705 001	332
05 056404 001	317	05 056938 001	342	05 057553 001	385	05 057710 001	332
05 056410 001	318	05 056939 001	342	05 057554 001	385	05 057715 001	332
05 056412 001	318	05 057110 001	276	05 057555 001	385	05 057720 001	332
05 056414 001	318	05 057111 001	276	05 057560 001	385	05 057725 001	332
05 056420 001	318	05 057115 001	452	05 057561 001	385	05 057750 001	324
05 056422 001	318	05 057116 001	444	05 057562 001	385	05 057751 001	318
05 056424 001	318	05 057117 001	441	05 057563 001	385	05 057752 001	316
05 056440 001	448	05 057122 001	448	05 057565 001	385	05 057753 001	321
05 056471 001	456	05 057150 001	400	05 057566 001	385	05 057760 001	342
05 056472 001	456	05 057151 001	400	05 057567 001	385	05 057761 001	340
05 056473 001	456	05 057152 001	400	05 057568 001	385	05 057762 001	340
05 056474 001	455	05 057153 001	400	05 057570 001	385	05 057763 001	338
05 056476 001	457	05 057160 001	400	05 057571 001	385	05 057770 001	356
05 056477 001	443	05 057161 001	400	05 057572 001	385	05 057771 001	354
05 056478 001	457	05 057162 001	400	05 057573 001	385	05 057772 001	352
05 056479 001	456	05 057163 001	400	05 057574 001	385	05 057773 001	356
05 056490 001	218	05 057210 001	379	05 057575 001	385	05 057774 001	354
05 056491 001	218	05 057213 001	379	05 057603 001	380	05 057775 001	352
05 056500 001	324	05 057223 001	379	05 057604 001	380	05 057776 001	352
05 056505 001	323	05 057225 001	379	05 057605 001	380	05 057790 001	389
05 056507 001	324	05 057230 001	379	05 057606 001	380	05 057908 001	449
05 056510 001	323	05 057235 001	379	05 057615 001	316	05 058005 001	348
05 056515 001	324	05 057240 001	379	05 057616 001	316	05 058010 001	348
05 056520 001	324	05 057250 001	379	05 057617 001	316	05 058015 001	348
05 056525 001	323	05 057255 001	379	05 057620 001	338	05 058020 001	348
05 056535 001	324	05 057402 001	447	05 057621 001	338	05 058025 001	348
05 056605 001	322	05 057404 001	447	05 057622 001	338	05 059030 001	111
05 056610 001	322	05 057412 001	446	05 057623 001	352	05 059291 001	108
05 056625 001	322	05 057414 001	446	05 057624 001	352	05 059293 001	270
05 056653 001	262	05 057415 001	446	05 057625 001	352	05 059294 001	272
05 056656 001	269	05 057416 001	445	05 057626 001	352	05 059295 001	272
05 056660 001	323	05 057417 001	435	05 057627 001	352	05 059297 001	273
05 056662 001	323	05 057418 001	220	05 057628 001	352	05 059298 001	268
05 056664 001	323	05 057420 001	440	05 057631 001	388	05 059299 001	268
05 056680 001	380	05 057421 001	444	05 057632 001	388	05 059305 001	378
05 056681 001	380	05 057422 001	459	05 057644 001	382	05 059307 001	378
05 056682 001	380	05 057423 001	458	05 057645 001	382	05 059310 001	378
05 056683 001	380	05 057424 001	460	05 057646 001	382	05 059315 001	378
05 056684 001	380	05 057425 001	438	05 057656 001	326	05 059320 001	378
05 056685 001	380	05 057426 001	459	05 057657 001	326	05 059325 001	378
05 056686 001	380	05 057427 001	459	05 057661 001	344	05 059330 001	378
05 056687 001	380	05 057428 001	449	05 057662 001	344	05 059335 001	378
05 056700 001	339	05 057429 001	449	05 057664 001	358	05 059337 001	378
05 056702 001	339	05 057430 001	440	05 057665 001	358	05 059340 001	378
05 056704 001	339	05 057431 001	444	05 057666 001	358	05 059345 001	378
05 056710 001	340	05 057432 001	458	05 057667 001	358	05 059450 001	378
05 056712 001	340	05 057433 001	458	05 057671 001	390	05 059451 001	378

Code No.	Page	Code No.	Page	Code No.	Page	Code No.	Page
05 066934	001 361	05 071090	001 367	05 072451	001 356	05 073342	001 381
05 066935	001 361	05 071091	001 367	05 072452	001 356	05 073344	001 381
05 066936	001 361	05 071092	001 367	05 073200	001 427	05 073346	001 356
05 066937	001 361	05 071094	001 367	05 073210	001 425	05 073357	001 422
05 066938	001 361	05 071097	001 390	05 073220	001 219	05 073370	001 341
05 066939	001 361	05 071098	001 390	05 073230	001 222	05 073371	001 341
05 066940	001 361	05 071099	001 390	05 073240	001 267	05 073372	001 341
05 066941	001 361	05 071100	001 414	05 073260	001 150	05 073373	001 341
05 066942	001 361	05 071101	001 382	05 073261	001 174	05 073375	001 356
05 066943	001 361	05 071102	001 382	05 073262	001 192	05 073376	001 356
05 066945	001 361	05 071103	001 382	05 073268	001 228	05 073380	001 342
05 066946	001 361	05 071104	001 382	05 073270	001 228	05 073391	001 242
05 066947	001 361	05 071105	001 382	05 073271	001 228	05 073401	001 422
05 066948	001 361	05 071106	001 382	05 073272	001 228	05 073403	001 62
05 066949	001 361	05 071107	001 382	05 073273	001 228	05 073404	001 454
05 066950	001 361	05 071108	001 382	05 073274	001 228	05 073406	001 452
05 071000	001 376	05 071109	001 438	05 073275	001 228	05 073410	001 450
05 071001	001 376	05 071110	001 438	05 073276	001 228	05 073416	001 451
05 071002	001 376	05 071116	001 270	05 073277	001 228	05 073418	001 442
05 071010	001 316	05 071117	001 271	05 073278	001 228	05 073419	001 445
05 071011	001 316	05 071222	001 401	05 073279	001 228	05 073420	001 414
05 071012	001 316	05 071223	001 401	05 073280	001 228	05 073421	001 415
05 071020	001 338	05 071224	001 401	05 073281	001 228	05 073495	001 402
05 071021	001 338	05 071225	001 401	05 073282	001 228	05 073500	001 402
05 071022	001 338	05 071228	001 401	05 073283	001 228	05 073501	001 402
05 071025	001 388	05 072014	001 511	05 073284	001 228	05 073502	001 402
05 071030	001 352	05 072017	001 511	05 073285	001 228	05 073503	001 402
05 071031	001 352	05 072050	001 377	05 073286	001 228	05 073504	001 402
05 071032	001 352	05 072055	001 377	05 073287	001 228	05 073505	001 402
05 071033	001 352	05 072057	001 377	05 073290	001 230	05 073506	001 402
05 071034	001 352	05 072059	001 377	05 073295	001 230	05 073507	001 402
05 071035	001 352	05 072061	001 377	05 073300	001 377	05 073508	001 402
05 071036	001 352	05 072063	001 377	05 073301	001 377	05 073509	001 402
05 071037	001 352	05 072065	001 377	05 073302	001 377	05 073510	001 402
05 071038	001 352	05 072070	001 324	05 073303	001 377	05 073511	001 417
05 071041	001 344	05 072072	001 324	05 073304	001 324	05 073512	001 322
05 071046	001 358	05 072074	001 324	05 073305	001 324	05 073513	001 322
05 071047	001 358	05 072080	001 342	05 073306	001 324	05 073514	001 322
05 071049	001 382	05 072082	001 342	05 073307	001 324	05 073515	001 322
05 071060	001 380	05 072084	001 342	05 073308	001 342	05 073516	001 341
05 071061	001 380	05 072400	001 324	05 073309	001 342	05 073517	001 341
05 071062	001 380	05 072401	001 324	05 073310	001 342	05 073518	001 341
05 071063	001 380	05 072402	001 324	05 073311	001 342	05 073519	001 341
05 071064	001 380	05 072403	001 343	05 073313	001 356	05 073520	001 330
05 071065	001 380	05 072404	001 343	05 073314	001 356	05 073521	001 330
05 071066	001 380	05 072405	001 343	05 073315	001 356	05 073522	001 330
05 071070	001 380	05 072406	001 356	05 073316	001 356	05 073523	001 347
05 071071	001 380	05 072407	001 356	05 073317	001 356	05 073524	001 347
05 071072	001 380	05 072408	001 356	05 073318	001 419	05 073525	001 347
05 071073	001 380	05 072409	001 356	05 073323	001 323	05 073526	001 360
05 071074	001 380	05 072410	001 356	05 073324	001 323	05 073527	001 360
05 071075	001 380	05 072411	001 356	05 073325	001 323	05 073528	001 360
05 071076	001 380	05 072412	001 356	05 073326	001 323	05 073529	001 360
05 071077	001 380	05 072440	001 324	05 073332	001 317	05 073530	001 360
05 071080	001 378	05 072441	001 324	05 073333	001 317	05 073531	001 360
05 071081	001 326	05 072443	001 343	05 073334	001 317	05 073534	001 446
05 071082	001 326	05 072444	001 343	05 073335	001 317	05 073536	001 453
05 071083	001 326	05 072446	001 356	05 073336	001 339	05 073537	001 454
05 071084	001 344	05 072447	001 356	05 073337	001 339	05 073538	001 455
05 071085	001 344	05 072448	001 356	05 073338	001 339	05 073540	001 284
05 071086	001 344	05 072449	001 356	05 073339	001 339	05 073541	001 285
05 071089	001 367	05 072450	001 356	05 073340	001 356	05 073544	001 238

Code No. Index

Code No.	Page	Code No.	Page	Code No.	Page	Code No.	Page
05 073593	001 240	05 073964	001 358	05 074822	001 481	05 078640	001 505
05 073594	001 243	05 073965	001 358	05 074822	010 481	05 078641	001 505
05 073596	001 244	05 073966	001 358	05 074824	001 481	05 078642	001 506
05 073598	001 252	05 073967	001 358	05 074824	010 481	05 078650	001 506
05 073599	001 252	05 073971	001 390	05 074826	001 483	05 078651	001 506
05 073610	001 316	05 073972	001 390	05 074826	010 483	05 078652	001 506
05 073611	001 316	05 073980	001 434	05 074828	001 483	05 078653	001 506
05 073612	001 316	05 073990	001 410	05 074828	010 483	05 078654	001 506
05 073613	001 338	05 074700	001 472	05 074840	001 481	05 078655	001 506
05 073614	001 338	05 074701	001 472	05 074840	010 481	05 078656	001 506
05 073615	001 338	05 074702	001 472	05 074842	001 481	05 078657	001 506
05 073616	001 414	05 074705	001 472	05 074842	010 481	05 078658	001 506
05 073620	001 352	05 074710	001 474	05 075604	001 492	05 078660	001 506
05 073621	001 352	05 074711	001 474	05 075605	001 492	05 078661	001 506
05 073622	001 352	05 074712	001 474	05 075610	001 494	05 078662	001 506
05 073623	001 352	05 074715	001 480	05 075611	001 494	05 078663	001 506
05 073624	001 352	05 074715	010 480	05 075620	001 495	05 078664	001 506
05 073625	001 352	05 074716	001 480	05 075621	001 495	05 078666	001 507
05 073626	001 352	05 074716	010 480	05 075622	001 496	05 078667	001 507
05 073630	001 438	05 074717	001 480	05 075623	001 496	05 078670	001 502
05 073634	001 439	05 074717	010 480	05 075624	001 497	05 078671	001 502
05 073635	001 455	05 074720	001 482	05 075630	001 497	05 078672	001 502
05 073637	001 456	05 074720	010 482	05 075651	001 498	05 078673	001 502
05 073638	001 456	05 074721	001 482	05 075652	001 498	05 078674	001 502
05 073640	001 216	05 074721	010 482	05 075653	001 499	05 078675	001 502
05 073645	001 220	05 074722	001 482	05 075654	001 499	05 078676	001 502
05 073660	001 290	05 074722	010 482	05 075655	001 500	05 078677	001 502
05 073661	002 290	05 074728	001 480	05 075656	001 500	05 078678	001 502
05 073665	001 289	05 074728	010 480	05 078200	001 504	05 078679	001 502
05 073670	001 85	05 074730	001 473	05 078205	001 505	05 078680	001 502
05 073671	001 85	05 074731	001 473	05 078210	001 505	05 078681	001 502
05 073675	001 70	05 074733	001 474	05 078345	001 505	05 078682	001 502
05 073676	001 71	05 074734	001 474	05 078600	001 502	05 078683	001 502
05 073677	001 70	05 074738	001 476	05 078601	001 502	05 078684	001 502
05 073680	001 63	05 074739	001 476	05 078602	001 502	05 078685	001 502
05 073681	001 63	05 074745	001 476	05 078603	001 502	05 078686	001 502
05 073720	001 360	05 074746	001 477	05 078604	001 502	05 078687	001 502
05 073721	001 360	05 074750	001 114	05 078605	001 502	05 078690	001 503
05 073722	001 360	05 074752	001 114	05 078606	001 502	05 078691	001 503
05 073723	001 360	05 074757	001 114	05 078607	001 502	05 078692	001 503
05 073724	001 360	05 074770	001 472	05 078608	001 502	05 078693	001 503
05 073890	001 436	05 074772	001 472	05 078609	001 502	05 078694	001 503
05 073904	001 380	05 074774	001 472	05 078610	001 502	05 078695	001 503
05 073905	001 380	05 074780	001 473	05 078611	001 502	05 078696	001 503
05 073906	001 380	05 074782	001 473	05 078612	001 502	05 078697	001 503
05 073916	001 316	05 074784	001 473	05 078620	001 503	05 078698	001 503
05 073917	001 316	05 074786	001 475	05 078621	001 503	05 078699	001 503
05 073921	001 338	05 074788	001 475	05 078622	001 503	05 078700	001 503
05 073922	001 338	05 074790	001 480	05 078623	001 503	05 078701	001 503
05 073924	001 352	05 074790	010 480	05 078624	001 503	05 078702	001 503
05 073925	001 352	05 074792	001 480	05 078625	001 503	05 078703	001 503
05 073926	001 352	05 074792	010 480	05 078626	001 503	05 078704	001 503
05 073927	001 352	05 074794	001 480	05 078627	001 503	05 078705	001 503
05 073931	001 388	05 074794	010 480	05 078628	001 503	05 078707	001 504
05 073932	001 388	05 074800	001 483	05 078629	001 503	05 078708	001 504
05 073944	001 382	05 074800	010 483	05 078630	001 503	05 078710	001 505
05 073945	001 382	05 074802	001 475	05 078631	001 503	05 078714	001 506
05 073946	001 382	05 074804	001 475	05 078632	001 503	05 078715	001 506
05 073956	001 326	05 074810	001 483	05 078633	001 503	05 078716	001 506
05 073957	001 326	05 074810	010 483	05 078635	001 504	05 078717	001 506
05 073961	001 344	05 074820	001 481	05 078636	001 504	05 078720	001 507
05 073962	001 344	05 074820	010 481	05 078637	001 504	05 078721	001 507

Code No.	Page	Code No.	Page	Code No.	Page	Code No.	Page
05 10000 001	94	05 104621 001	463	05 110055 001	35	05 118064 001	68
05 10001 001	94	05 104622 001	463	05 110068 001	44	05 118066 001	68
05 10002 001	94	05 104630 001	462	05 110069 001	44	05 118068 001	68
05 10003 001	94	05 104631 001	462	05 110070 001	44	05 118070 001	68
05 10004 001	94	05 104632 001	462	05 110075 001	44	05 118072 001	68
05 100011 001	95	05 104633 001	462	05 110078 001	44	05 118074 001	68
05 100012 001	95	05 104634 001	462	05 110104 001	34	05 118075 001	68
05 100015 001	96	05 104635 001	462	05 110105 001	34	05 118076 001	68
05 100016 001	96	05 104640 001	462	05 110150 001	35	05 118078 001	68
05 100019 001	97	05 104641 001	462	05 110151 001	35	05 118080 001	68
05 100020 001	97	05 104642 001	462	05 117680 001	41	05 118082 001	68
05 100021 001	98	05 104643 001	462	05 117681 001	41	05 118089 001	68
05 100022 001	98	05 104644 001	462	05 117682 001	41	05 118090 001	68
05 100024 001	100	05 104645 001	462	05 117683 001	41	05 118092 001	68
05 100025 001	100	05 104650 001	462	05 117684 001	41	05 118094 001	68
05 100026 001	100	05 104651 001	463	05 117685 001	41	05 118096 001	68
05 100030 001	35	05 104652 001	463	05 117686 001	41	05 118098 001	68
05 100031 001	35	05 104653 001	465	05 117687 001	41	05 118100 001	68
05 100042 001	34	05 104654 001	461	05 117688 001	41	05 118102 001	68
05 100043 001	34	05 104655 001	462	05 117689 001	41	05 118103 001	68
05 100044 001	34	05 104660 001	461	05 117691 001	41	05 118106 001	68
05 100050 001	36	05 104661 001	461	05 117990 001	66	05 118108 001	69
05 100051 001	36	05 104662 001	461	05 117991 001	66	05 118109 001	69
05 100052 001	36	05 104663 001	461	05 117992 001	66	05 118110 001	69
05 100055 001	37	05 104664 001	461	05 117993 001	66	05 118112 001	69
05 100056 001	37	05 104665 001	461	05 117994 001	66	05 118114 001	69
05 100057 001	37	05 104666 001	461	05 117995 001	66	05 118116 001	69
05 100060 001	39	05 104667 001	461	05 117997 001	66	05 118118 001	69
05 100061 001	39	05 104668 001	461	05 118000 001	66	05 118120 001	69
05 100062 001	39	05 104669 001	461	05 118002 001	66	05 118122 001	69
05 100063 001	39	05 104670 001	461	05 118003 001	66	05 118124 001	69
05 100064 001	39	05 104671 001	461	05 118004 001	66	05 118126 001	69
05 100070 001	41	05 104672 001	461	05 118005 001	66	05 118128 001	69
05 100071 001	41	05 104900 001	100	05 118006 001	66	05 118130 001	69
05 100072 001	41	05 104901 001	100	05 118007 001	66	05 118132 001	69
05 100075 001	28	05 104902 001	100	05 118008 001	66	05 118134 001	69
05 100076 001	28	05 104903 001	100	05 118010 001	66	05 118135 001	69
05 100077 001	28	05 104904 001	100	05 118012 001	66	05 118136 001	69
05 100080 001	29	05 104905 001	100	05 118014 001	66	05 118137 001	69
05 100081 001	29	05 104906 001	100	05 118017 001	66	05 118145 001	68
05 100082 001	29	05 104907 001	100	05 118019 001	66	05 118150 001	71
05 100085 001	28	05 105622 001	49	05 118020 001	66	05 118152 001	72
05 100086 001	28	05 105630 001	45	05 118022 001	66	05 118154 001	73
05 100087 001	28	05 105631 001	102	05 118023 001	66	05 118156 001	72
05 100100 001	101	05 105650 001	48	05 118024 001	66	05 118158 001	73
05 104600 001	463	05 105656 001	48	05 118026 001	66	05 118180 001	66
05 104601 001	463	05 110000 001	34	05 118030 001	66	05 118181 001	66
05 104602 001	463	05 110001 001	34	05 118032 001	66	05 118182 001	66
05 104603 001	463	05 110002 001	34	05 118035 001	67	05 118183 001	66
05 104604 001	463	05 110003 001	34	05 118036 001	67	05 118184 001	66
05 104605 001	463	05 110004 001	34	05 118037 001	67	05 118185 001	66
05 104610 001	463	05 110005 001	34	05 118039 001	67	05 118186 001	66
05 104611 001	463	05 110006 001	34	05 118040 001	67	05 133150 001	248
05 104612 001	463	05 110007 001	34	05 118042 001	67	05 133151 001	248
05 104613 001	463	05 110008 001	34	05 118044 001	67	05 133152 001	248
05 104614 001	463	05 110010 001	34	05 118046 001	67	05 133153 001	248
05 104615 001	463	05 110011 001	34	05 118048 001	67	05 133154 001	248
05 104616 001	463	05 110050 001	35	05 118050 001	67	05 133155 001	248
05 104617 001	463	05 110051 001	35	05 118052 001	67	05 133156 001	248
05 104618 001	463	05 110052 001	35	05 118054 001	67	05 133157 001	248
05 104619 001	463	05 110053 001	35	05 118060 001	68	05 133158 001	248
05 104620 001	463	05 110054 001	35	05 118062 001	68	05 133163 001	242

Code No. Index

Code No.	Page	Code No.	Page	Code No.	Page	Code No.	Page
05 133180 001	245	05 134683 001	369	05 135060 001	381	05 135235 001	370
05 133285 001	30	05 134684 001	369	05 135068 001	381	05 135264 001	379
05 133355 001	104	05 134685 001	369	05 135069 001	381	05 135265 001	379
05 133356 001	103	05 134686 001	369	05 135070 001	381	05 135266 001	379
05 133862 001	212	05 134687 001	369	05 135071 001	381	05 135267 001	379
05 134001 001	63	05 134688 001	369	05 135072 001	381	05 135268 001	386
05 134002 001	62	05 134690 001	369	05 135073 001	381	05 135269 001	386
05 134200 001	450	05 134691 001	369	05 135074 001	381	05 135270 001	335
05 134370 001	328	05 134695 001	368	05 135075 001	381	05 135271 001	335
05 134371 001	328	05 134698 001	372	05 135076 001	381	05 135272 001	335
05 134372 001	328	05 134699 001	372	05 135077 001	381	05 135273 001	335
05 134373 001	328	05 134700 001	372	05 135078 001	381	05 135274 001	335
05 134374 001	353	05 134701 001	372	05 135079 001	381	05 135275 001	335
05 134375 001	353	05 134702 001	372	05 135080 001	385	05 135276 001	335
05 134376 001	353	05 134703 001	372	05 135081 001	385	05 135277 001	335
05 134377 001	353	05 134704 001	372	05 135082 001	385	05 135278 001	335
05 134378 001	353	05 134705 001	372	05 135083 001	385	05 135280 001	335
05 134379 001	353	05 134706 001	372	05 135084 001	385	05 135281 001	335
05 134380 001	330	05 134707 001	372	05 135090 001	383	05 135284 001	335
05 134381 001	330	05 134720 001	373	05 135091 001	383	05 135285 001	335
05 134382 001	330	05 134722 001	373	05 135092 001	383	05 135286 001	335
05 134384 001	347	05 134723 001	373	05 135093 001	383	05 135287 001	335
05 134385 001	347	05 134732 001	373	05 135094 001	383	05 135288 001	335
05 134386 001	347	05 134740 001	360	05 135095 001	383	05 135289 001	335
05 134397 001	423	05 134800 001	391	05 135096 001	383	05 135290 001	335
05 134398 001	422	05 134801 001	391	05 135097 001	383	05 135291 001	335
05 134399 001	426	05 134802 001	391	05 135098 001	383	05 135380 001	336
05 134480 001	422	05 134805 001	391	05 135099 001	383	05 135381 001	336
05 134491 001	267	05 134806 001	391	05 135120 001	368	05 135382 001	336
05 134500 001	370	05 134807 001	391	05 135121 001	368	05 135383 001	336
05 134600 001	373	05 134905 001	324	05 135140 001	356	05 135384 001	336
05 134601 001	373	05 134906 001	328	05 135141 001	356	05 135385 001	336
05 134602 001	373	05 134907 001	328	05 135142 001	356	05 135386 001	336
05 134603 001	373	05 134908 001	328	05 135143 001	356	05 135387 001	336
05 134604 001	373	05 134909 001	328	05 135170 001	359	05 135400 001	364
05 134605 001	335	05 134910 001	328	05 135171 001	359	05 135401 001	364
05 134606 001	335	05 134911 001	328	05 135172 001	359	05 135402 001	364
05 134607 001	335	05 134912 001	328	05 135174 001	359	05 135403 001	364
05 134608 001	335	05 134913 001	328	05 135176 001	359	05 135404 001	364
05 134654 001	373	05 134914 001	328	05 135180 001	359	05 135405 001	364
05 134655 001	373	05 134915 001	328	05 135182 001	359	05 135406 001	364
05 134656 001	373	05 134919 001	318	05 135184 001	359	05 135407 001	364
05 134657 001	373	05 134920 001	318	05 135185 001	359	05 135408 001	364
05 134658 001	373	05 134921 001	318	05 135186 001	359	05 135409 001	364
05 134664 001	369	05 134929 001	328	05 135200 001	360	05 135420 001	365
05 134665 001	369	05 134930 001	328	05 135201 001	360	05 135421 001	365
05 134667 001	369	05 134931 001	328	05 135202 001	360	05 135422 001	365
05 134668 001	369	05 134932 001	328	05 135204 001	360	05 135423 001	365
05 134669 001	369	05 134940 001	318	05 135205 001	360	05 135424 001	365
05 134670 001	369	05 134941 001	318	05 135220 001	364	05 135425 001	365
05 134671 001	369	05 134942 001	318	05 135221 001	364	05 135430 001	370
05 134672 001	369	05 134950 001	328	05 135222 001	364	05 135431 001	370
05 134673 001	369	05 134951 001	328	05 135224 001	402	05 135432 001	370
05 134674 001	369	05 134952 001	328	05 135225 001	402	05 135433 001	370
05 134675 001	369	05 135003 001	340	05 135226 001	373	05 135434 001	370
05 134676 001	369	05 135005 001	321	05 135228 001	373	05 135435 001	370
05 134677 001	369	05 135008 001	319	05 135229 001	373	05 135436 001	370
05 134678 001	369	05 135009 001	321	05 135230 001	370	05 135440 001	370
05 134679 001	369	05 135017 001	340	05 135231 001	370	05 135441 001	370
05 134680 001	369	05 135040 001	325	05 135232 001	370	05 135442 001	370
05 134681 001	369	05 135041 001	325	05 135233 001	370	05 135443 001	370
05 134682 001	369	05 135042 001	325	05 135234 001	370	05 135530 001	330

Code No.	Page	Code No.	Page	Code No.	Page	Code No.	Page
05 135531 001	330	05 160901 001	331	05 344511 001	428	05 347778 001	51
05 135532 001	330	05 160908 001	331	05 344512 001	428	05 350430 001	383
05 135705 001	332	05 160917 001	369	05 344513 001	428	05 350451 001	476
05 135706 001	332	05 160924 001	423	05 344514 001	428	05 380033 001	383
05 135810 001	453	05 160956 001	368	05 344515 001	393	05 380045 001	383
05 135902 001	403	05 160976 001	423	05 344536 001	76	05 380046 001	383
05 135903 001	403	05 160977 001	423	05 344537 001	76	05 380047 001	383
05 135904 001	403	05 160979 001	423	05 344538 001	76	05 380048 001	383
05 135906 001	108	05 160981 001	423	05 344540 001	76	05 380049 001	383
05 135918 001	217	05 160983 001	328	05 344541 001	76	05 380050 001	383
05 135926 001	280	05 160987 001	417	05 344542 001	76	05 380103 001	381
05 135927 001	282	05 160988 001	417	05 344543 001	76	05 380104 001	381
05 135928 001	281	05 200495 001	373	05 344544 001	76	05 380105 001	381
05 135938 001	71	05 200995 001	220	05 344545 001	76	05 380106 001	381
05 135939 001	280	05 204126 001	373	05 344546 001	76	05 380107 001	381
05 135942 001	262	05 221102 001	385	05 344900 001	370	05 380108 001	381
05 135949 001	146	05 221110 001	393	05 345018 001	364	05 380109 001	381
05 135961 001	104	05 223161 001	50	05 345019 001	370	05 380110 001	381
05 135973 001	84	05 259135 001	373	05 345026 001	364	05 380124 001	384
05 136000 001	426	05 300004 001	83	05 345028 001	364	05 380125 001	384
05 136001 001	426	05 300025 001	374	05 345032 001	364	05 380126 001	384
05 136002 001	426	05 300037 001	374	05 345035 001	364	05 380127 001	384
05 136011 001	465	05 302400 001	370	05 345047 001	360	05 380128 001	384
05 136220 001	361	05 302402 001	370	05 345056 001	364	05 380129 001	384
05 136400 001	196, 213	05 302403 001	370	05 345280 001	100	05 380130 001	384
05 137810 001	60	05 308428 001	360	05 345281 001	69	05 380131 001	384
05 138070 001	38	05 311517 001	426	05 345282 001	69	05 380155 001	319
05 138250 001	51	05 314753 001	364	05 345284 001	68	05 380156 001	319
05 138257 001	40	05 319835 001	360	05 345285 001	68	05 380157 001	319
05 138258 001	40	05 320430 001	369	05 345290 001	66	05 380158 001	319
05 138259 001	40	05 320540 001	50	05 345350 001	364	05 380160 001	328
05 138260 001	40	05 324901 001	393	05 345351 001	364	05 380161 001	328
05 138261 001	40	05 326310 001	370	05 345352 001	364	05 380200 001	330
05 138262 001	40	05 328448 001	360	05 346280 001	286	05 380201 001	330
05 138263 001	40	05 328463 001	85	05 346281 001	319	05 380202 001	330
05 138264 001	40	05 332600 001	360	05 346285 001	331	05 380380 001	336
05 138265 001	40	05 332606 001	370	05 346286 001	331	05 380381 001	336
05 138266 001	40	05 332607 001	364	05 346287 001	331	05 380382 001	336
05 138268 001	40	05 332609 001	364	05 346288 001	383	05 380383 001	336
05 138269 001	40	05 332610 001	364	05 346293 001	216	05 480171 001	322
05 138270 001	40	05 332612 001	370	05 347100 001	422	05 480172 001	322
05 140310 001	294	05 340245 001	389	05 347106 001	46	05 480173 001	322
05 160785 001	149	05 340260 001	442	05 347107 001	110	05 480221 001	341
05 160821 001	373	05 340322 001	453	05 347108 001	110	05 480222 001	341
05 160830 001	360	05 340330 001	34	05 347153 001	442	05 480223 001	341
05 160885 001	383	05 342920 001	353	05 347735 002	49	05 670446 001	303
05 160895 001	331	05 344280 001	370	05 347736 002	50	05 670447 001	303
05 160896 001	329	05 344281 001	370	05 347743 001	37	05 670448 001	303
05 160899 001	329	05 344282 001	370	05 347777 001	104		

Article No. Index

1

100	514
100 L	515
100 S	514
101	514
101 L	515
102	514
102 L	515
160 i SB	94
160 i VDE	94
160 i/162 i/167 i/9	104
160 i/165 i/7 Rack	103
160 i/168 i/6 Rack	104
160 i/6 Rack	102
160 i/7 Rack	102
160 iS	94
160 iS/7	104
160 iSS	94
160 iSS/7	104
162 i PH SB	95
162 i PH VDE	95
162 i PH/S SB	97
162 i PH/S VDE	97
162 iS	96
162 iS PH/S	98
162 iSS	96
164 i VDE	99
165 i PZ SB	96
165 i PZ VDE	96
165 i PZ/S SB	98
165 i PZ/S VDE	98
165 iS	97
165 iS PZ/S	98
165 iSS PZ/S	98
167 i TORX® VDE	99
167 i/6	103
168 i SB	100
168 i VDE	100
190 i VDE	100
1013 Kraftform Micro	70
1013 Kraftform Micro ESD	83
1160 i VDE	122
1160 i/1165 i/7 VDE	123
1160 i/7 VDE	122
1162 i PH VDE	122
1165 i PZ VDE	122

1267 A TORX PLUS®	61
1267 A TORX®	61
1267 B TORX PLUS®	61
1267 B TORX®	61
1334	54
1334/1355/6	56
1334/6	56
1335	54
1335/1350/1355/6	56
1350 PH	54
1355 PZ	54
1367 TORX®	55
1367/6 TORX®	56
1427	62
1428	62
1429	69
1430 ESD	475
1440/1442	63
1441	63
1460 Micro ESD	483
1550 PH Micro	80
1550/6 ESD	82
1555 PZ Micro	80
1567 TORX PLUS® IPR	81
1567 TORX® BO	81
1567 TORX® HF Micro	80
1567 TORX® Micro	81
1569 ESD	82
1572 ESD	82
1578 A Micro	80
1578 A/6	82

2

247	101
247 SB	101
2035 Micro	66
2035/6 A	71
2035/6 B	72
2050 PH Micro	66
2050/6	72
2052 Micro	68
2052/6	72
2054 Micro	68
2055 PZ	66
2067 IPR Micro	68
2067 TORX®	67
2067 TORX® BO Micro	67

2067 TORX® HF	66
2067/6 TORX® B0	73
2069 Micro	69
2069/6	73
2072	68
2090 90 Nm	511
2090/17	511

3

300 Hex	486
300 Hex Pistole / Pistol	486
300 IP	486
300 IP Pistole / Pistol	487
300 TX	486
300 TX Pistole / Pistol	487
334	34
334 SB	35
334 SK	34
334 SK/6	48
334/355 SK/6	48
334/355/6 Rack	48
334/368/6	51
334/6	48
335	34
335/350/355/3	49
335/350/355/4	50
335/350/355/6	49
335/350/367/7 Lasertip	50
336 Stubby	44
350 PH	36
350 PH SB	36
350 SK PH	36
352	38
354 Hex-Plus	38
355 PZ	37
355 SB	37
355 SK PZ	37
367 K TORX®	40
367 SB	39
367 TORX PLUS®	40
367 TORX®	39
367 TORX® B0	40
367 TORX® HF	38
367/4 TORX HF extra lang / long	50
367/6 TORX®	51
367/6 TORX® B0	51
367/6 TORX® HF	50
367/7 TORX® HF	50

368	41
368 SB	41
371 TORQ-SET® Mplus	40
375 TRI-WING®	42
378 B	35
391	42
392	287
395	42
395 H0	43
395 H0/7 SM	51
3160 i VDE	90
3160 i/7 Rack	91
3162 i VDE	90
3165 i PZ VDE	90
3165 i/6 Rack	91
3334	22
3334/3350/3355/6	25
3334/3355/6	24
3334/6	24
3335	22
3350 PH	22
3355 PZ	22
3367 TX	23
3368	23
3800/1 TS	376
3800/4	378
3816 R	284
3840/1 TS	380
3840/4 Hex-Plus	382
3851/1 TS PH	316
3851/4	326
3855/1 TS PZ	338
3855/4	344
3867/1 TS SB SiS	352
3867/1 TS TORX®	352
3867/4 TORX®	358
3867/4 TORX® B0	367
3868/1 TS	388
3868/4 Square-Plus	390
3869/4	401
3888/4/1 K	414
3888/4/1 K SB SiS	414
3950 PKL	246
3950 PKL inch	246
3950 SPKL Multicolour	246
3950/9 Hex-Plus Imperial Stainless 1	239
3950/9 Hex-Plus Multicolour Stainless 1	238
3950/9 Hex-Plus Stainless 1	238
3950/9 Hex-Plus Stainless 1 SB	238
3950/9 Hex-Plus Stainless 1 SB	238

Article No. Index

4

454	76
454 inch	76
467 TORX®	76
489 R	77
495	77

6

68	294
----	-----

7

700 A HTS	397
700 B HTS	397
700 C HTS	397
712	293
780 A	428
780 B	428
780 C	428
784 A/1	428
784 B	428
784 C	428
797 A/4/1 B	418
797 B/4/1 B	418
7400	472
7400 ESD	473
7400 ESD Halfmoon	475
7400 ESD inch	474
7400 ESD vor Halfmoon	483
7400 inch	474
7400 Pistole / Pistol	472
7400 Pistole / Pistol inch	474
7400 Pistole / Pistol pre-set	480
7400 Pistole pre-set inch	482
7400 VDE	114
7400 pre-set	480
7400 pre-set ESD	481
7400 pre-set inch	482
7440/41	476
7440/41/42	476

7443/12	477
7443/61/9	476
7445/46/47	476
7770	502
7771	503
7772 A	504
7772 B	504
7772 C	504
7773 A	504
7773 B	505
7773 C	505
7774/1	505
7774/2	505
7774/3	506
7775	506
7776	506
7779/1	507
7779/2	507
7780	502
7781	503
7782 C	504
7782 E	504
7783 C	505
7783 E	505
7786	506
7790/1	507
7790/2	507

8

80	292
80 RA	289
81	293
82	293
83	294
84	294
85	294
86	294
87	294
88/1	292
800/1 BDC	376
800/1 BTZ	376
800/1 HTN	397
800/1 TZ	376
800/1 Z	377
800/1 Z Set D	377
800/1 Z Set SB	377

800/2 Z	379	849/855/867/18	465
800/4 Z	378	851/1 A PH	318
800/9 C	379	851/1 ADC PH	318
807/4 Z	379	851/1 AH	319
810/1 ESD	85	851/1 BDC PH	317
810/1 Vario	287	851/1 BDC SB	317
811/1 ESD	85	851/1 BTH PH	318
811/1 Vario	287	851/1 BTZ PH	318
812/1 Vario	287	851/1 IMP DC	316
813	287	851/1 IMP DC SB	316
813 R	284	851/1 J	325
813 R ESD	84	851/1 RDC PH	319
816 R	284	851/1 RH	319
816 R ESD	83	851/1 RZ PH	321
816 RA	288	851/1 RZ SB	321
817 R	285	851/1 TH PH	322
817 R SB SiS	285	851/1 TiN PH	322
817 VDE	114	851/1 TiN SB	322
819/1 Vario	286	851/1 TZ PH	323
819/1/6	286	851/1 TZ SB	323
819/1/6 PH	286	851/1 Z DIY 100	324
820/1/6	286	851/1 Z DIY	324
830	292	851/1 Z PH	324
840/1 BTZ Hex-Plus	380	851/1 Z SB	324
840/1 IMP DC	380	851/11 PH	333
840/1 IMP DC Impaktor Bits SB	380	851/12 PH	333
840/1 Z Hex-Plus	381	851/15 PH	334
840/1 Z Hex-Plus BO	387	851/16 PH	334
840/1 Z Set SB SiS	381	851/2 Z PH	332
840/2 Z	385	851/21 J	335
840/4 IMP DC	382	851/22	336
840/4 IMP DC SB	382	851/23 PH	332
840/4 Z Hex-Plus	383	851/25 H	336
840/4 Z Hex-Plus BO	387	851/4 A PH	328
840/9 C	386	851/4 ADC PH	328
842/1 Z	381	851/4 BDC PH	326
842/4	384	851/4 BTH PH	327
843	461	851/4 BTZ PH	327
844	461	851/4 IMP DC	326
844/7	461	851/4 IMP DC SB	326
845	461	851/4 J	330
845/8	462	851/4 PH/S	350
846 HSS	462	851/4 R PH	329
846/8	462	851/4 RH	328
847 HSS	462	851/4 TH PH	329
847/7 HSS	463	851/4 TZ PH	330
848 HSS	463	851/4 TZ SB	330
848/851/867/19	463	851/4 Z PH	330
849 HSS	463	851/4 Z SB	330

Article No. Index

8

851/9 C	335	867/1 IP TORX PLUS®	368
853/1 TZ ACR PH	323	867/1 IPR	372
853/4 ACR	331	867/1 TORX®	356
853/4 Harpoon ACR	331	867/1 TORX® BDC	353
855/1 BDC PZ	339	867/1 TORX® BTZ	354
855/1 BDC SB	339	867/1 TZ TORX®	355
855/1 BTH PZ	340	867/1 Z TORX® BO	366
855/1 BTZ PZ	340	867/1 Z TORX® HF	354
855/1 IMP DC	338	867/1 Z TORX® W	357
855/1 IMP DC SB	338	867/1 ZA TORX®	357
855/1 RZ PZ	340	867/11 TORX®	362
855/1 TH PZ	341	867/12 TORX®	362
855/1 TiN PZ	341	867/15 TORX®	363
855/1 TiN SB	341	867/16 TORX®	363
855/1 TZ PZ	342	867/2 Z TORX®	361
855/1 Z DIY 100	343	867/21 IPR TORX® PLUS	374
855/1 Z DIY	343	867/21 TORX PLUS®	370
855/1 Z PZ	342	867/21 TORX®	364
855/1 Z SB	342	867/22 TORX PLUS®	370
855/11 PZ	348	867/22 TORX®	365
855/12 PZ	349	867/4 H TORX®	359
855/15 PZ	349	867/4 IMP DC	358
855/2 Z PZ	348	867/4 IMP DC SB	358
855/4 BDC PZ	346	867/4 IP TORX PLUS®	369
855/4 BTH PZ	346	867/4 IPR	373
855/4 BTZ PZ	346	867/4 KK	358
855/4 IMP DC	344	867/4 TORX® HF	359
855/4 IMP DC SB	344	867/4 Z TORX®	360
855/4 PZ/S	351	867/4 Z TORX® BO	367
855/4 TH PZ	347	867/9 C TORX PLUS®	370
855/4 TZ PZ	347	867/9 C TORX®	364
855/4 TZ SB	347	867/9 IPR TORX® PLUS	373
855/4 Z PZ	347	868/1 BTZ Square-Plus	388
855/4 Z SB	347	868/1 IMP DC	388
856/1 TZ ACR PZ	342	868/1 IMP DC SB	388
857/1 Z	400	868/1 V	389
857/4 Z	400	868/1 Z	389
860/1 XZN	396	868/4 BTZ Square-Plus	390
860/4 XZN	396	868/4 IMP DC	390
864/1 BTZ	375	868/4 IMP DC SB	390
864/1 Z	375	868/4 Square-Plus	391
867/1 BDC SB	353	868/4 V	391
867/1 IMP DC	352	869/4	401
867/1 IMP DC SB	352	869/4 M	402
		869/4 M SB	402
		869/4 M Set A SB	402
		869/9	402
		870/1	426
		870/14	427

870/2	426	897/4 R SB	414
870/4	427	898/21	420
870/4 A	426	898/4	420
870/4/7 Set A SB	427	898/9	420
870/7	427	899/14/1	423
8700 A FL	165	899/14/1 SB	423
871/1 DC TORQ-SET® Mplus	392	899/3/1	422
871/1 TORQ-SET® Mplus 25 mm	392	899/4/1	422
871/1 TORQ-SET® Mplus 32 mm	392	899/4/1 S	423
871/19 TORQ-SET® Mplus	394	899/4/1 SB	422
871/2 TORQ-SET® Mplus	394	899/5/1	423
871/4 DC TORQ-SET® Mplus	393	899/8/1	423
871/4 TORQ-SET® Mplus	393	899/8/1 K	423
871/6 TORQ-SET® Mplus	394	8000 A	150
871/7 TORQ-SET® Mplus	394	8000 A SB	150
872/21	398	8000 B	174
872/9	398	8000 B SB	174
875/1 TRI-WING® 25 mm	395	8000 C	192
875/1 TRI-WING® 32 mm	395	8000 C SB	192
875/4 TRI-WING®	395	8000 E	196
875/6 TRI-WING®	395	8001 A SB	222
879/4	403	8002 C Koloss All Inclusive Set	212
887/4 RR	417	8002 C Koloss	212
887/4 RR SB	417	8003 A	153
888/4/1 K	416	8003 B	177
889/4 R	416	8003 C	199
889/4/1	416	8004 A	155
889/4/1 K	415	8004 B	179
890/00/0	421	8004 C	201
890/4/1	421	8005	222
890/6/1	421	8006 C	196
890/7/1	421	8006 SC 1	194
890/7/2	421	8007 B VDE	126
891/4/1	424	8100 SA 10	152
891/8/1	424	8100 SA 11	154
893/4/1 K	422	8100 SA 12 HF	155
893/4/1 K SB	422	8100 SA 2	148
894/14/1	419	8100 SA 4	148
894/4/1	419	8100 SA 6	144
894/4/1 K	419	8100 SA 7	152
895/14/1	420	8100 SA 8	154
895/4/1	420	8100 SA 9	145
895/4/1 K	419	8100 SA All-In	144
895/4/1 K SB	419	8100 SA/SC 2	149
896/4/1 SB	425	8100 SB 10	176
897/4 Impaktor Impaktor	410	8100 SB 11	178
897/4 Impaktor Impaktor R	410	8100 SB 2	173
897/4 Impaktor R SB	410	8100 SB 4	174
897/4 R	414	8100 SB 6	172

Article No. Index

8

8100 SB 7	176
8100 SB 8	178
8100 SB 9	172
8100 SB HF 1	179
8100 SB VDE 1	129
8100 SC 10	198
8100 SC 11	200
8100 SC 2	191
8100 SC 4	192
8100 SC 6	190
8100 SC 7	198
8100 SC 8	200
8100 SC 9	190
8740 A	162
8740 A HF	162
8740 A HF 1	163
8740 B HF	183
8740 B HF 1	184
8740 B HF Imperial 1	184
8740 C HF	206
8740 C HF 1	205
8740 C HF 2	206
8751 A	164
8755 A	164
8767 A HF	160
8767 A HF 1	161
8767 B HF	182
8767 B HF 1	182
8767 C HF	204
8767 C HF 1	204
8767 C HF 2	204
8767 C HF 3	205
8780 C	212
8781 C	213
8782 C	213
8784 A1	169
8784 B1	186
8784 C2	209
8789 A	166
8789 B	187
8789 C	209
8790 B VDE	126
8790 C HF 1	203
8790 FA	223

8790 HMA	156
8790 HMA HF	156
8790 HMB	180
8790 HMB HF	180
8790 HMC	202
8790 HMC HF	202
8794 A	169
8794 B	187
8794 C	209
8794 LA	166
8794 LB	186
8794 LB VDE	128
8794 LC	208
8794 SA	167
8794 SB	186
8794 SB VDE	128
8794 SC	208
8795 A	169
8795 B	187
8795 C	209
8796 LA	166
8796 LB	186
8796 LC	208
8796 SA	166
8796 SB	186
8796 SC	208
8797 C	196

9

91	292
95	292
917 SPH	28
917 SPH SB	28
917 SPHS	28
918 SPZ	29
918 SPZ SB	29
919 PH	257
919 PZ	257
920 A	257
930 A	60
930/935/6	60
930/955/6	60
932 A	28
932 A SB	28
932 AS	28
932 S/6	30

932/6	30
932/918/6	31
935 SPH	60
950	249
950 BM	249
950 L	248
950 PKL	247
950 PKL BM	247
950 PKL inch	248
950 PKLS	248
950 PKS	248
950 SPKL HF Multicolour	246
950 SPKL inch	247
950 SPKL Multicolour	247
950/13 Hex-Plus Imperial 1	245
950/7 Hex-Plus 1	244
950/7 Hex-Plus Magnet 1	244
950/7 Hex-Plus Multicolour Magnet 1	241
950/9 Hex-Plus 3	242
950/9 Hex-Plus 1	242
950/9 Hex-Plus 1 SB	242
950/9 Hex-Plus 2	242
950/9 Hex-Plus 4	243
950/9 Hex-Plus 5	243
950/9 Hex-Plus 6	244
950/9 Hex-Plus 6 SB	244
950/9 Hex-Plus 7	244
950/9 Hex-Plus Imperial 1	245
950/9 Hex-Plus Imperial 1 SB	245
950/9 Hex-Plus Multicolour 1	240
950/9 Hex-Plus Multicolour 1 SB	240
950/9 Hex-Plus Multicolour HF 1	240
950/9 Hex-Plus Multicolour Imperial 1	241
955 SPZ	60
967 L TORX® HF	256
967 PKL TORX®	256
967 PKXL TORX®	256
967 SL TORX® HF	254
967 SPKL TORX® BO Multicolour	254
967 SPKXL TORX® Multicolour	253
967 SXL HF TORX® Multicolour	253
967 SXL TORX® Multicolour	254
967 TORX®	256
967 XL HF TORX®	254
967 XL TORX®	256
967/9 TX 1	252
967/9 TX BO Multicolour 1	212
967/9 TX HF 1	250
967/9 TX Multicolour HF 1	250
967/9 TX XL Multicolour HF 1	250

967/9 TX XL 1	252
967/9 TX XL HF 1	250
967/9 TX XL Multicolour 1	251
977 TORX®	29
977/6 TORX®	31

ABC

BC 10 Drywall 1	465
Belt A 1	157
Belt A 2	162
Belt A 3	161
Belt A 4	159
Belt A Imperial 1	160
Belt A, 8-teilig / 8 location, unbestückt / unloaded	163
Belt A, 9-teilig / 9 location, unbestückt / unloaded	164
Belt B 1	181
Belt B 2	184
Belt B 3	182
Belt B 4	181
Belt B Imperial 1	184
Belt B, 8-teilig / 8 location, unbestückt / unloaded	185
Belt B, 9-teilig / 9 location, unbestückt / unloaded	185
Big Pack 900	30
Bit-Box 15 Impaktor PH	316
Bit-Box 15 Impaktor PZ	338
Bit-Box 15 Impaktor TX	352
Bit-Box 20 BTH PZ	340
Bit-Box 20 BTZ PH	318
Bit-Box 20 BTZ PZ	340
Bit-Box 20 BTZ TX	354
Bit-Box 20 PH	324
Bit-Box 20 PZ	342
Bit-Box 20 RZ PH	321
Bit-Box 20 TX	356
Bit-Box 20 V Robertson	389
Bit-Check 10 BiTorsion 1	441
Bit-Check 10 BiTorsion 2	441
Bit-Check 10 BiTorsion 3 SB	442
Bit-Check 10 Diamond 1	444
Bit-Check 10 Impaktor 1	434
Bit-Check 10 Impaktor 1 SB	434
Bit-Check 10 Impaktor 2	434
Bit-Check 10 Impaktor 3	434

Article No. Index

ABC

Bit-Check 10 Impaktor 4	435	Bit-Check 6 PH Impaktor 1	436
Bit-Check 10 PZ BiTorsion 1	442	Bit-Check 6 PZ Diamond 1	447
Bit-Check 10 PZ BiTorsion 2	442	Bit-Check 6 PZ Impaktor 1	436
Bit-Check 10 PZ Impaktor 1	435	Bit-Check 6 PZ Universal 1	456
Bit-Check 10 PZ Universal 1	451	Bit-Check 6 Stainless 1 SB	439
Bit-Check 10 PZ Universal 2	451	Bit-Check 6 TX HF 1	457
Bit-Check 10 Stainless 1	438	Bit-Check 6 TX Impaktor 1	436
Bit-Check 10 Stainless 1 SB	438	Bit-Check 6 TX Universal 1	456
Bit-Check 10 TX Impaktor 1	435	Bit-Check 6 TX Universal 1 SB	456
Bit-Check 10 TX Universal 1	452	Bit-Check 6 Universal 1	455
Bit-Check 10 TX Universal 2	452	Bit-Check 6 Universal 1 SB	455
Bit-Check 10 Universal 1	450	Bit-Check 6 Universal 2	456
Bit-Check 10 Universal 2	450	Bit-Check 6 Universal 3	456
Bit-Check 10 Universal 3	450	Bit-Check 6 V Universal 1	457
Bit-Check 10 Universal 3 SB	450	Bit-Check 7 Diamond 1	445
Bit-Check 10 Universal 4	450	Bit-Check 7 Diamond 1 SB	445
Bit-Check 10 Universal 5 SB	451	Bit-Check 7 Hex-Plus 1	454
Bit-Check 10 Zyklus Mini 1	220	Bit-Check 7 PH BiTorsion 1	443
Bit-Check 10 Zyklus Mini BiTorsion 1	220	Bit-Check 7 PH Diamond 1	446
Bit-Check 12 BiTorsion 1	440	Bit-Check 7 PZ BiTorsion 1	442
Bit-Check 12 Diamond 1	444	Bit-Check 7 PZ Diamond 1	446
Bit-Check 12 Metal 1	460	Bit-Check 7 PZ Diamond 1 SB	446
Bit-Check 12 Stainless 1	438	Bit-Check 7 PZ Universal 1	453
Bit-Check 12 Universal 1	449	Bit-Check 7 PZ Universal 1 SB	453
Bit-Check 12 Universal 2	449	Bit-Check 7 PZ Universal 2	453
Bit-Check 12 Wood 1	458	Bit-Check 7 TiN Universal 1	454
Bit-Check 12 Wood 2	459	Bit-Check 7 TiN Universal 1 SB	454
Bit-Check 12 Wood 3	459	Bit-Check 7 TX B0 Universal 1	454
Bit-Check 12 Wood 4	459	Bit-Check 7 TX Diamond 1	446
Bit-Check 30 BiTorsion 1	440	Bit-Check 7 TX Universal 1	454
Bit-Check 30 Diamond 1	444	Bit-Check 7 TX Universal 1 SB	454
Bit-Check 30 Impaktor 1	434	Bit-Check 7 Universal 1	452
Bit-Check 30 Metal 1	460	Bit-Check 7 Universal 2	453
Bit-Check 30 Stainless 1	438	Bit-Check 7 Universal 3	453
Bit-Check 30 TX Universal 1	449	Bit-Check 7 Universal 4	453
Bit-Check 30 Universal 1	448	Bit-Safe 43 Universal 1	448
Bit-Check 30 Wood 1	458	Bit-Safe 61 BiTorsion 1	440
Bit-Check 30 Wood 2	458	Bit-Safe 61 Universal 1	448
Bit-Check 30 Zyklus Mini 1	216	Bit-Safe 61 Universal 2	448
Bit-Check 30 Zyklus Mini 2	216	Bit-Safe 61 Wood 1	458
Bit-Check 6 Impaktor 1	436	Click-Torque A 5	492
Bit-Check 6 Impaktor 2	436	Click-Torque A 6	492
Bit-Check 6 PH BiTorsion 1	443	Click-Torque B 1	494
Bit-Check 6 PH Diamond 1	447	Click-Torque B 2	494
		Click-Torque C 1	495
		Click-Torque C 2	495
		Click-Torque C 3	496
		Click-Torque C 4	496
		Click-Torque C 5	497

Click-Torque E 1	497	Kraftform Kompakt 64 i	117
Click-Torque X 1	498	Kraftform Kompakt 65 i PZ	115
Click-Torque X 2	498	Kraftform Kompakt 65 i PZ/S	116
Click-Torque X 3	499	Kraftform Kompakt 65 iS PZ	115
Click-Torque X 4	499	Kraftform Kompakt 65 iS PZ/S	116
Click-Torque X 5	500	Kraftform Kompakt 67 i TORX®	116
Click-Torque X 6	500	Kraftform Kompakt 67 iS TORX®	117
Joker	228	Kraftform Kompakt 68 i	117
Joker Double	228	Kraftform Kompakt 68 iS	117
Joker inch	228	Kraftform Kompakt 70 Allround	276
Joker Set 4	230	Kraftform Kompakt 71 Security	276
Joker Set 6	229	Kraftform Kompakt 96 VK 6,3	118
Joker Set Switch	231	Kraftform Kompakt 97 VK 8,1	118
Joker Switch	230	Kraftform Kompakt 98 DK	118
Joker Switch inch	230	Kraftform Kompakt 99 FL	118
Joker Set 4 inch SB	230	Kraftform Kompakt Pistol RA	290
Joker Set switch 4 inch	231	Kraftform Kompakt Pistol RA 4	290
Joker Set 11	228	Kraftform Kompakt VDE 15 Torque	
Joker Set 8 inch	229	1,2-3,0 Nm extra slim 1	108
Joker Set Switch 11	232	Kraftform Kompakt VDE 16 extra slim 1	112
Joker Set Switch 8	232	Kraftform Kompakt VDE 16 Torque	
Kraftform Kompakt 10	262	1,2-3,0 Nm	108
Kraftform Kompakt 12	262	Kraftform Kompakt VDE 16 Universal 1	112
Kraftform Kompakt 20	264	Kraftform Kompakt VDE 17 Universal 1	111
Kraftform Kompakt 20 A	264	Kraftform Kompakt VDE 18 Imperial 1	110
Kraftform Kompakt 22	264	Kraftform Kompakt VDE 18 Universal 1	109
Kraftform Kompakt 25	266	Kraftform Kompakt VDE 18 Universal 2	110
Kraftform Kompakt 26	266	Kraftform Kompakt VDE 7 Imperial 1	113
Kraftform Kompakt 27 RA 1 SB	290	Kraftform Kompakt VDE 7 Universal 1	113
Kraftform Kompakt 27 RA 2 SB	290	Kraftform Kompakt VDE 7 Universal 2	113
Kraftform Kompakt 40	268	Kraftform Kompakt Zyklus Mini 2	217
Kraftform Kompakt 41	268	Klettstreifen / Hook and Loop	
Kraftform Kompakt 50	269	Fastener Strips 1	303
Kraftform Kompakt 60	272	Klettstreifen Hook and Loop	
Kraftform Kompakt 60 ESD	84	Fastener Strips 2	303
Kraftform Kompakt 60 i	114	Klettstreifen Hook and Loop	
Kraftform Kompakt 60 Imperial	272	Fastener Strips 3	303
Kraftform Kompakt 60 iS	114	Kraftform 2go 100	105
Kraftform Kompakt 60 KK	272	Kraftform 2go 300	46
Kraftform Kompakt 60 RA	288	Kraftform Big Pack 100 VDE	102
Kraftform Kompakt 60 RA Imperial	288	Kraftform Big Pack 300	45
Kraftform Kompakt 60 Stainless	270	Kraftform Kompakt 100	278
Kraftform Kompakt 60 Stainless Imperial	271	Kraftform Kompakt 20 Tool Finder 1	264
Kraftform Kompakt 60 Torque	270	Kraftform Kompakt 28 mit Tasche /	
Kraftform Kompakt 62	273	with pouch	267
Kraftform Kompakt 62 i	114	Kraftform Kompakt 28 SB	267
Kraftform Kompakt 62 i PH/S	116	Kraftform Kompakt H1 Holz	280
Kraftform Kompakt 62 iS	115	Kraftform Kompakt M1 Metall	281
Kraftform Kompakt 62 iS PH/S	116	Kraftform Kompakt Micro 11 Electronics 1	71

Article No. Index

ABC

Kraftform Kompakt Micro 11 ESD 1	85
Kraftform Kompakt Micro 11 Universal 1	71
Kraftform Kompakt Micro 20 ESD 1	85
Kraftform Kompakt Micro 21 ESD 1	84
Kraftform Kompakt SH 1	282
Kraftform Kompakt Vario RA	289
Kraftform Kompakt W1 Wartung	280
Kraftform Kompakt Zyklus	150
Kraftform Kompakt Zyklus MS1	
Metal/Speed 1/4	146
Kraftform Micro 12 Electronics 1	70
Kraftform Micro 12 Universal 1	70
Kraftform XXL	45
Kraftform XXL 2	46
Kraftform XXL 3	46
Mutterentnahme-Werkzeug / Nut Extractor	159
Rack	63
Rack Micro	62
Stubby PH	44
Stubby PZ	44
Tool-Check 1 SB	219
Tool-Check Automotive 1	220
Tool-Check PLUS	218
Tool-Check PLUS Imperial	218
Wera 2go 1	300
Wera 2go 2	300
Wera 2go 3	300
Wera 2go 4	300
Wera 2go 5	301
Wera 2go 6	301
Wera Star	62
Zyklus Hybrid Set	194

Alphabetical Index

All products from A to Z

A

Adaptors	292, 426, 427, 428
Assembly set for tyre pressure control systems	476, 477
ASSY®	
Bits	375
Awl	62

B

Ballhead	
Bits	272, 358, 381, 384
Screwdrivers	38, 40
Belts	157, 159, 160, 161, 162, 163, 164, 181, 182, 184, 185
Bit-Box	316, 318, 321, 324, 338, 340, 342, 352, 354, 356, 389
Bit-Checks	216, 220, 434, 435, 436, 438, 439, 440, 441, 442, 443, 444, 445, 446, 447, 448, 449, 450, 451, 452, 453, 454, 455, 456, 457, 458, 459, 460, 465
Bit-Safes	440, 448, 458
Bitholding Kraffform Micro Screwdrivers	70
Bitholding Screwdrivers	77, 83, 84, 85, 284, 285, 286, 287
BiTorsion	
Bits	317, 318, 326, 327, 339, 340, 346, 353, 354, 375, 376, 380, 388, 390, 440, 441, 442, 443
Bit Holder	418
Bit Sets	440, 441, 442, 443
Bits	
ACR (Anti Cam-Out Ribs)	323, 331, 342
ASSY®	375
BiTorsion	317, 318, 326, 327, 339, 340, 346, 353, 354, 375, 376, 380, 388, 390, 440, 441, 442, 443
Countersink Bits	461, 462
Diamond-coated	317, 318, 319, 326, 328, 339, 346, 353, 376, 392, 393, 444, 445, 446, 447
Double-ended Bits	332
Drill bits	462, 463, 465
Halfmoon	335, 364, 370, 373, 379, 386
Hex-Plus	380, 381, 382, 383, 384, 385, 386, 387
Hexagon socket screws	380, 381, 382, 383, 384, 385, 386
Hexagon socket screws BO	387

Alphabetical Index

All products from A to Z

B

Bits

Hi-TORQUE	397
HIOS	335, 336, 364, 365, 370, 398
Impaktor	316, 326, 338, 344, 352, 358, 380, 382, 387, 388, 390, 434, 435, 436
Microstix®	398
Multipoint	396
Phillips PH	316, 317, 318, 319, 321, 322, 323, 324, 325, 326, 327, 328, 329, 330, 331, 332, 333, 334, 335, 336, 347
pias	375
PlusMinus PH-S	350
PlusMinus PZ-S	351
Pozidriv PZ	321, 338, 339, 340, 341, 342, 343, 344, 346, 347, 348, 349
Reduced shank diameter	319, 321, 340
Single Tap Bits	461
Slotted	376, 377, 378, 379
Snake Eye	400
Spanner	400
Square socket screws	388, 389, 390, 391
Stainless Steel	316, 326, 338, 344, 352, 358, 367, 376, 378, 380, 382, 388, 390, 438, 439
Stepped drill bits	461
TiN-coated	322, 341, 454
TORQ-SET®	392, 393, 394
TORX®	352, 353, 354, 355, 356, 358, 359, 360, 361, 362, 363, 364, 365
TORX® B0	366, 367
TORX® Wedge	357
TORX® with Safety Pin	357
TORX PLUS®	368, 369, 370
TORX PLUS® IPR	372, 373, 374
TRI-WING®	395

Bits with Holding Function

TORX®	354, 359
-------	----------

Bit Holder

Adjustable depth stop	425
BiTorsion	418
Combination HIOS&Halfmoon	420
Copper Beryllium Sleeve	424
Impaktor	410, 414

Bit Holder

Quick Release Chuck	419, 420
Rapidaptor	414, 415, 416, 417
Rapidaptor Ring Magnet	417
Rapidaptor Stainless Steel	414
Retaining Ring	421
Stainless Steel Sleeve	422, 423

Bit Sets

Bit-Checks	216, 220, 434, 435, 436, 438, 439, 440, 441, 442, 443, 444, 445, 446, 447, 448, 449, 450, 451, 452, 453, 454, 455, 456, 457, 458, 459, 460, 465
Bit-Safes	440, 448, 458
BiTorsion	440, 441, 442, 443
Diamond	444, 445, 446, 447
Impaktor	434, 435, 436
Metal	460
Stainless	438, 439
Universal	448, 449, 450, 451, 452, 453, 454, 455, 456, 457
Wood	458, 459

Bit Sockets

Hexagon socket	162
Hexagon socket screws with Holding Function	162, 163, 183, 184, 205, 206
Slotted	165
TORX [®] with Holding Function	160, 161, 182, 204, 205

C

Chip lifter	69
Chiseldriver	28, 29, 30, 31, 60
Countersink Bits	461, 462

D

Diamond-coated Bits	317, 318, 319, 326, 328, 339, 346, 353, 376, 392, 393, 444, 445, 446, 447
Double-ended Bits	332
Drill bits	462, 463, 465

Alphabetical Index

All products from A to Z

E

Electronics Screwdrivers	66, 67, 68, 69, 70, 71, 72, 73, 80, 81, 82, 84
ESD Tools	82, 83, 84, 85, 473, 474, 475, 481, 483

F

Flagdrivers	
TORX®	61
TORX PLUS®	61

G

Guide Sleeves	379
----------------------	-----

H

Halfmoon	
Bits	335, 364, 370, 373, 379, 386
Hex-Plus	
Bit Sockets	162
Bit Sockets with Holding Function	162, 163, 183, 184, 205, 206
Bits	380, 381, 382, 383, 384, 385, 386, 387
L-Keys	238, 239, 240, 241, 242, 243, 244, 245, 246, 247, 248, 249, 256
Screwdrivers	38
Hexagon socket screws	
Bits	380, 381, 382, 383, 384, 385, 386
Bit Sockets	162
Bit Sockets with Holding Function	162, 163, 183, 184, 205, 206
L-Keys	240, 241, 242, 243, 244, 245, 246, 247, 248, 249, 256
L-Keys extra short arm	243, 248
Screwdrivers	38
Hexagon socket screws B0	
Bits	387
Hi-TORQUE	
Bits	397

HIOS

Bits

335, 336, 364, 365, 370, 398

Hose Clamp Screwdrivers

42

I

Impact Drivers

511

Impaktor

Bits

316, 326, 338, 344, 352, 358, 380, 382, 387, 388, 390,
434, 435, 436

Bit Holder

410, 414

Bit Sets

434, 435, 436

Insulated Tools

94, 95, 96, 97, 98, 99, 100, 102, 103, 104, 108, 109, 110,
111, 112, 113, 114, 122, 123, 126, 128, 129

with reduced blade diameter

94, 96, 97, 98, 104, 111, 112, 114, 115, 116, 117

Internal thread insertion tools

403

J

Joker

228, 229, 230, 231, 232

K

Koloss

212, 213

Kraftform Kompakt 10

262

Kraftform Kompakt 20

264, 266, 267, 290

Kraftform Kompakt 40

268

Kraftform Kompakt 50

269

Kraftform Kompakt 60

270, 271, 272, 273

Kraftform Kompakt 70

276

Kraftform Kompakt 100

278

Kraftform Kompakt Ratchet

288, 289, 290

Kraftform Kompakt user-specific sets

280, 281, 282

Kraftform Kompakt Vario

289, 292, 293, 294

Kraftform Kompakt VDE (insulated)

108, 109, 110, 111, 112, 113, 114, 115, 116, 117, 118

Kraftform Micro

66, 67, 68, 69, 70, 71, 72, 73, 80, 81, 82, 84

Alphabetical Index

All products from A to Z

L

L-Keys

extra short arm	243, 248
Hex-Plus	238, 239, 240, 241, 242, 243, 244, 245, 246, 247, 248, 249, 256
Hexagon socket screws	240, 241, 242, 243, 244, 245, 246, 247, 248, 249, 256
TORX [®]	212, 250, 251, 252, 253, 254, 256
TORX [®] B0	212, 254
with Holding Function TORX [®]	240, 246, 250, 254, 256

M

Magnetizer

Demagnetizer	62
--------------	----

Microstix[®]

Bits	398
Screwdrivers	68, 82

Multipoint

Bits	396
------	-----

N

Nutsetters

42, 43, 51, 401, 402

O

Offset Screwdrivers

257

P

Phillips PH

Bits	316, 317, 318, 319, 321, 322, 323, 324, 325, 326, 327, 328, 329, 330, 331, 332, 333, 334, 335, 336, 347
Bit Sockets	164
Screwdrivers	22, 36, 54, 90

pias

Bits	375
------	-----

PlusMinus PH-S

Bits	350
Screwdrivers	97, 98, 116

PlusMinus PZ-S

Bits	351
Screwdrivers	98, 116

Pozidriv PZ

Bits	321, 338, 339, 340, 341, 342, 343, 344, 346, 347, 348, 349
Bit Sockets	164
Screwdrivers	22, 37, 54, 90

R

Rack

Kraftform	63
Kraftform Micro	62

Rapidaptor

Bit Holder	414, 415, 416, 417
Bit Holder Ring Magnet	417
Stainless Steel	414

Ratchets

Koloss	212
Koloss Accessories	213
Zyklop Accessories	156, 166, 167, 169, 180, 186, 187, 196, 202, 203, 204, 205, 206, 208, 209
Zyklop Hybrid	194, 196
Zyklop Metal	144, 146, 152, 153, 154, 155, 176, 177, 178, 179, 198, 199, 200, 201
Zyklop Mini	216, 217, 218, 219, 220, 222
Zyklop Mini Accessories	223
Zyklop Speed	126, 144, 145, 146, 148, 149, 150, 155, 172, 173, 174, 190, 191, 192
Zyklop VDE	126, 128, 129

Alphabetical Index

All products from A to Z

R

Ratchet Wrenches 228, 229, 230, 231, 232

Reamer 62

S

Screwdrivers

Hex-Plus 38

Hexagon socket screws 38

Phillips PH 22, 36, 54, 90

PlusMinus PH-S 97, 98, 116

Pozidriv PZ 22, 37, 54, 90

Slotted 22, 34, 35, 54, 60, 90

Square socket screws 23, 41

TORQ-SET® 40

TORX® 23, 39, 40, 51, 55

TORX® BO 40, 51

TORX PLUS® 40

TORX PLUS® IPR 68, 81

TRI-WING® 42

Wood 60

Screwdrivers PlusMinus PH-S 97, 98

Screwdrivers PlusMinus PZ-S 98, 116

Screwdrivers with Holding Function

TORX® 38, 50, 66, 80

Screwdriver Sets 45, 46, 48, 49, 50, 51, 56

Screwdriver Sets Big Pack 30, 45, 102

Screwdriver Sets Kraftform 2go 46, 102

Screwdriver Sets XXL 45, 46

Screw Gripper 63

Single Tap Bits 461

Slotted

Bits 376, 377, 378, 379

Bit Sockets 165

Screwdrivers 22, 34, 35, 54, 60, 90

Snake Eye

Bits 400

Sockets	
with Holding Function	144, 155, 179, 202, 203
Soft-faced Hammers	514, 515
Spanner	
Bits	400
Square socket screws	
Bits	388, 389, 390, 391
Screwdrivers	23, 41
Stainless Steel Tools	
Bitholding Screwdrivers	284
Bits	316, 326, 338, 344, 352, 358, 367, 376, 378, 380, 382, 388, 390, 438, 439
Bit Sets	438, 439
Kraftform Kompakt	270, 271
L-Keys	238, 239, 246
Nutsetters	401
Screwdrivers	22, 23, 24, 25, 90, 91
Stepped drill bits	461
Stubbies	
Carburettor Screwdrivers	44
T-Handle Screwdrivers	76, 77
Thread drive Bits	333, 334, 348, 349, 362, 363
Tool-Check	218, 219, 220
Toolfinder Take it easy	
Bit-Checks	434, 435, 436, 438, 440, 441, 442, 443, 444, 445, 446, 447
Bit-Safes	440
Bits	264, 316, 317, 318, 326, 327, 338, 339, 340, 344, 346, 352, 353, 354, 358, 376, 380, 382, 387
Bit Sockets	204, 205, 206
Joker	228, 229, 230, 231, 232
L-Keys	212, 238, 240, 241, 246, 247, 250, 251, 252, 253, 254
Ratchet Sets	144, 145, 146, 148, 149, 150, 152, 153, 154, 155, 172, 173, 174, 176, 177, 178, 179, 190, 191, 192, 194, 196, 198, 199, 200, 201, 216, 217, 218, 219, 220
Screwdrivers	22, 23, 24, 25, 34, 35, 36, 37, 38, 39, 45, 44, 45, 46, 48, 49, 50, 51, 90, 91, 94, 95, 96, 97, 98, 99, 102, 103, 104, 105
Sockets	156, 180, 202, 203

Alphabetical Index

All products from A to Z

T

TORQ-SET®

Bits	392, 393, 394
Screwdrivers	40

Torque Tools

ESD	473, 474, 475, 481, 483
Insert Tools	502, 503, 504, 505, 506, 507
Torque-indicators	486, 487
Torque Screwdrivers	108, 270, 472, 474, 476, 480, 482
Torque Wrenches Click-Torque	492, 494, 495, 496, 497, 498, 499, 500
VDE	108, 114

TORX®

Bits	352, 353, 354, 355, 356, 358, 359, 360, 361, 362, 363, 364, 365
Bits with Holding Function	354, 359
Bits with Safety Pin	357
Bit Sockets with Holding Function	160, 161, 182, 204, 205
Flagdrivers	61
L-Keys	212, 250, 251, 252, 253, 254, 256
L-Keys with holding Function	240, 246, 250, 254, 256
Screwdrivers	23, 39, 40, 51, 55
Screwdrivers with holding Function	38, 50, 66, 80

TORX® BO

Bits	366, 367
L-Keys	212, 254
Screwdrivers	40, 51

TORX PLUS®

Bits	368, 369, 370
Flagdrivers	61
Screwdrivers	40

TORX PLUS® IPR

Bits	372, 373, 374
Screwdrivers	68, 81

TRI-WING®

Bits	395
Screwdrivers	42

U

Unlocking pin 196, 213

V

Vario 289, 292, 293, 294

Voltage tester 101

W

Wera 2go 300, 301, 303

Wera Star 62

Wooden Handle Screwdrivers 60

Z

Zyklop

Accessories 156, 166, 167, 169, 180, 186, 187, 196, 202, 203,
204, 205, 206, 208, 209

Hybrid 194, 196

Metal 144, 146, 152, 153, 154, 155, 176, 177, 178, 179,
198, 199, 200, 201

Mini 216, 217, 218, 219, 220, 222

Mini Accessories 223

Speed 126, 144, 145, 146, 148, 149, 150, 155, 172, 173,
174, 190, 191, 192

VDE 126, 128, 129

Regional Contacts



Wera Werkzeuge GmbH

Korzterter Straße 21-25
42349 Wuppertal

+49 / (0)202 / 40 45 - 311
Fax: +49 / (0)202 / 40 36 34

E-Mail: info@wera.de



Germany

04654 Frohburg
Industrievertretung Jens Hiensch
+49 / (0)157 / 71 90 78 21
E-Mail: jens.hiensch@iv-hiensch.de

26160 Bad Zwischenahn
Ralf Saul
+49 / (0)4403 / 91 00 972
E-Mail: r.saul@wera.de

64342 Seeheim-Jugenheim
Layer OHG
+49 / (0)6257 / 86 96 0
E-Mail: info@layer-ohg.de

09326 Geringswalde
IMS Lonthoff
+49 / (0)1525 / 39 81 570
E-Mail: info@ims-lonthoff.de

42111 Wuppertal
HKL Industrievertretungen GmbH
+49 / (0)202 / 47 00 01
E-Mail: hkl@wera.de

78132 Hornberg
Industrievertretung Markus Haberstroh
+49 / (0)7833 / 955 54 86
E-Mail: m.haberstroh@haberstroh-industrievertretung.de

10961 Berlin
Werksvertretung Peter Raschke
+49 / (0)177 / 74 90 484
E-Mail: raschke@wv-raschke.de

42349 Wuppertal
Dirk Blasius - Verkaufsleiter NRW
+49 / (0)202 / 40 45 204
E-Mail: blasius@wera.de

88489 Wain
Thorsten Schilder Handelsvertretung
+49 / (0)7353 / 528 48 74
E-Mail: thorsten.schilder@wera.de

21465 Reinbek
Rosendahl & Koppel
Inh. Mark Petersen e.K.
+49 / (0)40 / 23 41 47
E-Mail: mark.petersen@roko-petersen.de

58256 Ennepetal
Ulrich Hesselmann
+49 / (0)2333 / 83 92 37
E-Mail: ulrich.hesselmann@wera.de

90455 Nürnberg
Dietz OHG
+49 / (0)9129 / 90 57 50
E-Mail: dietz@wera.de

Europe

AT - 5412 Puch
Alpen-MayKestag GmbH
+43 / (0)662 / 44 901-0
E-Mail: verkauf@a-mk.com

B - 1600 Sint-Pieters-Leeuw
Beltracy S.A.
+32 / (0)2 / 54 36 890
E-Mail: info@beltracy.be

BG - 1421 Sofia
Mr. Nikola Ivanov
+359 / (0)2 / 96 31 900
E-Mail: weraw@mail.bg

CH - 1026 Denges
Metalsa SA
+41 / (0)21 / 80 45 050
E-Mail: info@metalsa.ch

CZ - 180 82 Praha 8
ABQ AGENCY s.r.o.
+420 / (0)2 / 28 38 41 981
E-Mail: info@abefekt.cz

DK - 2730 Herlev
HJS Værktøj A/S
+45 / 44 84 40 44
E-Mail: hjs@hjs.dk

Wera Iberia
C./Mogoda, 1-5 (Edificio Nodus)
Pno. Ind. Can Salvatella
E - 08210 Barberà del Vallès / Barcelona
+34 / 93 / 7 29 7-2 40
Fax: +34 / 93 / 7 29 7-2 41
E-Mail: juan.pires@weraspain.com

EST - 1415 Tallinn
AS Stokker
+372 / 6 / 20 11 11
E-Mail: timmo.eenmaa@stokker.com

EST - 12618 Tallinn
Toolmarketing OÜ
+372 / 6 / 09 64 36
E-Mail: info@toolmarketing.eu

Wera Outillages S.A.S.
13, rue Ampère
F - 67500 Haguenau
+33 / 9 72 61 16 52
E-Mail: info@wera-outillages.fr

FIN - 01511 Vantaa
Wihuri Oy Technical Trade
+358 / (0)20 / 51 02 364
E-Mail: info@wihuri.fi

Wera Tools UK Ltd.
Units 1 & 2, McGregor's Way
Turnoaks Business Park
GB - Chesterfield S40 2WB
+44 / (0)1246 / 27 77 56
Fax: +44 / (0)1246 / 27 33 35
E-Mail: queries@wera-tools.co.uk

GR - 166 72 Vari
Costas J. Kessissoglou
+30 / 210 / 96 37 521
E-Mail: kessi@hol.gr

I - 20097 San Donato Milanese
Carlo Stechel & Figli srl
+39 / 02 52 77 71
E-Mail: wera@stechel.it

For more regional contacts please see

www.wera.de, www.weratools.com and www.wera-tools.co.uk

Regional Contacts

Europe

 **LT-69320 Klaipėdos raj.**
UAB GITANA
+370 / 46 / 410881
E-Mail: info@gitana.lt

 **N - 0787 Oslo**
MORGENSTIERNE verktøy AS
+47 / (0)22 / 49 28 00
E-Mail: tools@morgenstierne.no

  **NL - Nord**
Gerard Kluck
+31 / 65 28 52 622
E-Mail: kluck@wera.de

  **NL - Süd**
Wouter Steijvers
+31 / 65 28 50 162
E-Mail: steijvers@wera.de

 **PL - 61-306 Poznań**
Agentools Sp. z o.o. Sp. k.
+48 / (0)61 / 87 19 000
E-Mail: info@agentools.pl

 **RO-400441 Cluj-Napoca**
Mr. Victor Martes
+40 / 741 / 072 479
E-Mail: rominfocom@gmail.com

 **RUS - 119454 Moskau**
KNIPEX 000
+7 / 495 / 73 73 497
E-Mail: info@knipec.ru



 **RUS-143581 Moskau**
000 „ЦИТ“ ЦЕНТРОИНСТРУМЕНТ
+7- / 495 / 789 73 14/15
E-Mail: wera@centro-i.ru

 **S - 163 53 Spånga**
Hansson & Frife AB
+46 / (0)8 / 76 02 510
E-Mail: hansson.frife@esma.se

 **SRB-11030 Beograd**
ELTEC Export-Import d.o.o
+381 / 11 / 3555 - 065
E-Mail: info@eltec.rs

North America (Canada, USA, Mexico)

  **CA - Burlington, Ontario**
Wera Tools Inc.
1 - 800 - 267 - 5541
E-Mail: info@weratools.com

  **CA - Burlington, Ontario**
Wera Tools Inc.
1 - 800 - 267 - 5541
E-Mail: info@weratools.com

  **CA - Burlington, Ontario**
Wera Tools Inc.
+ 1 - 905 - 637 - 0003
E-Mail: info@weratools.com

South America

 **AR - 1879 Buenos Aires**
Quilmes Neumática S.A.
+54 / 11 42 50 03 65 int.21
E-Mail: rudi@quilmesneumatica.com

 **BR - 09601-000 São Bernardo do Campo-SP**
DFG Comércio Importação
Exportação e Representação Ltda
+55 / 11 49 41 21 51
E-Mail: www.dfgferramentas.com.br

 **CL - Santiago de Chile**
Comercial e Industrial Ilesa S.A.
+56 / 23 62 70 00

Australia and Oceania

 **AU - Australia - 2147 Seven Hills**
Cabac
+61 / 13 31 22
E-Mail: sales@cabac.com.au

 **NZ - 1060 Auckland**
Ecco Pacific Ltd.
+64 0800 77 6969
E-Mail: sales@cabac.co.nz

 **NZ - 8023 Christchurch**
Blacks Fasteners
+64-3-3652460
E-Mail: sydenham@blacksfasteners.co.nz

Asia

 **CN - 201206 Shanghai**
KNIPEX Tools Co., Ltd.
+86 / 21 58 99 80 10
E-Mail: info@knipec.com.cn

  **Wera Tools Japan G.K.**
+81 70 4813 1142
E-Mail: frank.yang@wera.de

 **SG - 575625 Singapore**
Wing Poh Hardware Pte Ltd
+65 / 62 50 05 23

 **Matfron Industrial Automatic**
(Shanghai) Co., Ltd
+86 / 021 / 66 24 91 22
E-Mail: service@matfron.com

 **IN - 411001 Pune**
Nikita Distributors & Extreme
Adventure Sports
+91 / 20 30 50 06 14
E-Mail: raman.jp@gmail.com

 **TW - 114 Taipei City / Taiwan R.O.C**
Inhand Corporation
+886 / 2 / 63 19 53 8

 **KR - 10463 Gyunggi-Do**
LnJ Korea
+82 / 31 / 96 61 429
E-Mail: LNJ2100@gmail.com

 **IN - 600 125 Chennai**
Rapidtec Enterprises
+91 994 036 6621
E-Mail: rapidtec2011@gmail.com

 **TW - 11483 Taipei / Taiwan R.O.C.**
Duramet Corporation
+886 / 2 / 26 32 24 88

 **KR - 08531 Seoul**
Protool Co., LTD.
E-Mail: sejin@protool.co.kr

 **VN - Ho Chi Minh City, Vietnam**
THE GIOI MOI EQUIPMENT AND ENGINEERING
SOLUTION JOINT STOCK COMPANY (THE GIOI MOI JSC)
+84-28-66 80 88 75
E-Mail: thegioimoijscvn@gmail.com

Middle East

 **IL - Tel-Aviv 61573**
Tenegal Agencies Ltd.
+972 / (0)3 / 56 17 411
E-Mail: menahem@tenegal.com

JO, LB, IR, SY, KW, BH, QA, OM, AE, SA, JE
KNIPEX Tools Middle East FZE
+971 / 48 87 85 56
E-Mail: info@knipec-tools.com

 **IR - 15866-45915 Tehran / Iran**
Abzarsara Co.
+98 / 21 88 81 31 20
E-Mail: info@abzarsara.com



 **IR - 15866-45915 Tehran / Iran**
FourSat Kish Co Ltd.
+98 / 21 88 60 24 84
E-Mail: arash.etminan@foursat.com

Which type of bit is needed for which job?



Impaktor-Bits

Impact-Bits are needed when a strong power tool (e.g. 18 volt impact screwdriver) is used. Impact bits were specifically developed to withstand high power tool forces.



TH-Bits

TH-Bits are hard bits with a torsion zone. Torsion bits absorb the damaging peak torque loads in the torsion zone. This prevents premature wear and enhances the service life of the bits.



Stainless Steel-Bits

Wera stainless steel bits are manufactured out of stainless steel so unsightly rust can be avoided. The stainless steel bits from Wera are vacuum ice-hardened and have the hardness and strength needed for screw connections. There are no limitations to the industrial applications they are suitable for.



J-Bits

J stands for Japan. J bits have been optimised to suit Asian PH screws. In particular, they are for use with very small dimensions as set out in the Japanese Camera Standard.



BDC-Bits

BDC-Bits are absolutely premium products. They have a softer BiTorsion zone which reduces the hardness of the shaft by about 20 % in comparison to the drive tip. This means that the peak loads that cause bit breakage and premature wear are absorbed in this zone – something which enhances the service life of the bits. The diamond coating lowers the danger of slipping as the minute diamond particles literally “bite” themselves into the screw head. B stands for BiTorsion. DC stands for diamond coated.



ACR®-Bits

ACR® stands for “anti-cam-out ribs”. ACR® bits have ribs at the drive tip that protect against slipping out of the screw head. It is recommended that ACR® bits are matched with ribbed ACR® screws for maximum effect. ACR® is a registered trademark of Phillips Screw Company.



BTH-Bits

BTH-Bits have an additional tempered BiTorsion zone, which reduces the hardness of the shaft by about 20 % in comparison to the drive tip. This means that the peak loads that cause bit breakage and premature wear are absorbed in this zone – something which enhances the service life of the bits.



TiN-Bits

TiN stands for titanium-nitrite. An extremely hard coating to withstand permanent loads such as during continual screwdriving operations in series manufacturing.



BTZ-Bits

BTZ-Bits have an additional tempered BiTorsion zone, which reduces the hardness of the shaft by about 20 % in comparison to the drive tip. This means that the peak loads that cause bit breakage and premature wear are absorbed in this zone – something which enhances the service life of the bits.



DC-Bits

The diamond coating of the DC bits lowers the danger of slipping as the minute diamond particles literally “bite” themselves into the screw head.



TZ-Bits

TZ-Bits are tough bits with a torsion zone. Torsion bits absorb the damaging peak torque loads in the torsion zone. This prevents premature wear and enhances the service life of the bits.



Bits with reduced shaft diameter

Bits with reduced shaft diameter ensure that screws can be sunk without damaging the surface. This is particularly necessary in drywall construction applications.



A-Bits

A stands for aviation. A bits are particularly hard bits with a sharp-edged profile which e.g. penetrates screw profiles full of paint (such as on fuselage panels) ensuring a dependable transfer of force between the bit and the screw.

Imprint

Subject to technical modifications!

Any reprinting – even only excerpts – shall only be permissible with the prior written consent of the company Wera Werkzeuge GmbH.

Edition: EN 2018

Printed in Germany

Trademarks used:

ACR	Phillips Screw Company
ASSY	Adolf Würth GmbH & Co. KG
AW	Adolf Würth GmbH & Co. KG
HIOS	Totsu, Katsuyuki
Microstix	OSG System Products Co. Ltd.
Phillips Recess	Phillips Screw Company
Pozidriv	registered trademark for Phillips Screw Company in Canada, Mexico and in the USA; for Trifast plc in the UK
PZ	registered trademark for Phillips Screw Company in Canada, Mexico and in the USA
PZ1, PZ2, PZ3	registered trademark in the USA for Phillips Screw Company
Robertson	British Robertson S.L.U.
SDS plus	Robert Bosch GmbH
SIT	Adolf Würth GmbH & Co. KG
SPAX	SPAX International GmbH & Co. KG
T-STAR plus	SPAX International GmbH & Co. KG
TORQ-SET	Phillips Screw Company
TORX	Acument Intellectual Properties, LLC, Troy, Mich., US
TORX PLUS	Acument Intellectual Properties, LLC, Troy, Mich., US
TRI-WING	Phillips Screw Company

We reserve the right to modify without prior notification any details stated in this catalogue regarding product features, versions and designs.

No liability for printing errors or mistakes shall be assumed.



Contact us

All regions (except for North America, UK and Republic of Ireland)

Wera Werkzeuge GmbH · Germany
Korzter Straße 21–25
D-42349 Wuppertal

Phone: +49 (0) 202 / 40 45-0
Fax: +49 (0) 202 / 40 36 34
E-Mail: info@wera.de

Internet:
www.wera.de

North America

Wera Tools Inc.
4129 Harvester Rd, Unit H
Burlington, Ontario
Canada, L7L 5M3

Phone: 1-800-267-55 41
E-Mail: info@weratools.com

Internet:
www.weratools.com

UK & Republic of Ireland

Wera Tools UK LTD
Units 1 & 2, McGregor's Way
Turnoaks Business Park, Chesterfield
Derbyshire, S40 2WB
Great Britain

Phone: +44 / (0) 12 46 / 27 77 56
E-Mail: queries@wera-tools.co.uk

Internet:
www.wera-tools.co.uk

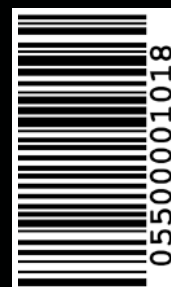

EN 05 500001 018 - 0052570 - 01