

windas

High Quality Tools Distributor

Jl.Kelapa Hibrida VIII Ra 23 No 12a
Kelapa Gading, Jakarta 14250
Phone : +62 21 45841539 / 4535134 / 4500784
Fax : +62 21 4513002
Hotline : +62 812 1818784
E-mail : info@windas.co.id
Web : www.windas.co.id
Marketplace : www.tokopedia.com/windas



Screwdriving Tools for the Aerospace Segment





Content

Screwdriver Bits	4
Bitholders and Adaptors	28
Combination ratchet wrenches	32
Ratchets	36
Torque Tools	62
Screwdrivers	66
Kraftform Kompakt Tools	79
L-Keys	86



Precision engineered tools for the challenges of Aerospace maintenance operations

With the increasing economic pressures on the global Aerospace industry, Wera recognizes the importance of the maintenance operations of all carriers, whether they are passenger, commercial or military. Wera is constantly working to improve on the status-quo, and provide new solutions to the unique challenges of aerospace maintenance. There have been several traditional suppliers of fastening tools to the Aerospace industry over the past few years, however Wera has chosen to improve on the status-quo.

Perhaps the best example of the innovative character of Wera, specifically related to the Aerospace market, was the introduction of our patented TORQ-SET® Mplus screwdriver bits. The uniquely improved geometry of the Mplus bits provides for

better fit in the screws, higher torque transfer, and less cam-out. Most importantly for the MRO activities, the strongest benefit of the Mplus technology is seen during the removal of fasteners which have been in service and are probably filled with paint or in slightly less-than-perfect condition. When you add the patented diamond-coating to the Mplus profile, you've got a combination that can handle the most stubborn removal challenge.

We are sure that you will find many useful solutions to your fastening challenges in the pages of our new Aerospace brochure. And if we can provide any additional technical assistance or if you have a particular challenge you can't find a solution for, please contact our local representatives.

The Wera Bits Range

Tools. From Ideas.

Wera provides professional technicians with exceptional product ideas. In practical applications these ideas – with their often unique features – result in a truly professional screwdriving performance. The extensive range of Wera screwdriver bits contains the best tools for different types of fasteners. Wera's bits are designed for the toughest applications. Through careful selection of materials, and strictly controlled manufacturing processes, Wera bits fulfil the highest quality requirements. They provide the transfer of high torque values, and deliver a long service life.



Bits with Impaktor technology

The Impaktor technology ensures the best possible performance, even under extreme conditions, through optimization of material properties and geometry, making them ideal for use with impact drivers.



Bits with diamond coating

Bits with a rough diamond coating on their surface, reduce the danger of cam-out, due to increased surface friction.



A stands for aviation

These bits are particularly hard bits with a sharp-edged profile which e.g. penetrates screw profiles full of paint (such as on fuselage panels) ensuring a dependable transfer of force between the bit and the screw.



Bits with reduced shaft diameter

Bits with reduced shaft diameter ensure that screws can be sunk without damaging the surface.

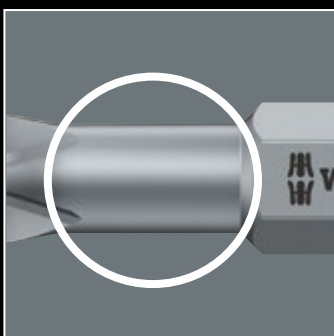

Bits with Torsion zone

Bits with a torsion zone absorb the damaging peak torque loads in the torsion zone. This prevents premature wear and enhances the service life of the bits.



Bits for Phillips Screws

851/1 IMP DC Impaktor bits



Application: Phillips screws

Drive: 1/4" hexagon, suitable for DIN 3126-D 6.3, ISO 1173 bit holders

Design: The Impaktor technology ensures an above-average service life even under extreme conditions thanks to a best-possible utilisation of the material properties and optimally designed geometry, particularly suitable for use with conventional impact drivers, the rough diamond coating reduces the danger of any slipping out of the screw head due to the enhanced frictional resistance

Code	+	mm	mm					
05057616001	PH 2	25	1"					10
05057617001	PH 3	25	1"					10

851/1 A bits

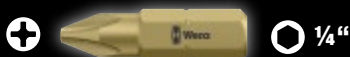

Application: Phillips screws

Drive: 1/4" hexagon, suitable for DIN 3126-D 6.3, ISO 1173 bit holders

Design: Robust and efficient bits for allround purposes, profiled version

Code	+	mm	mm	mm				
05134918001	PH 0	25	1"	3.0				10
05134919001	PH 1	25	1"	4.5				10
05134920001	PH 2	25	1"	6.0				10
05134921001	PH 3	25	1"	-				10

851/1 RH bits

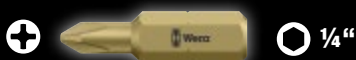

Application: Phillips screws

Drive: 1/4" hexagon, suitable for DIN 3126-D 6.3, ISO 1173 bit holders

Design: Reduced shaft diameter, robust and efficient bits for allround purposes, profiled version

Code	+	mm	mm	mm				
05380158001	PH 1	25	1"	4.2				10
05346281001	PH 2	25	1"	4.2				10

851/1 ADC bits

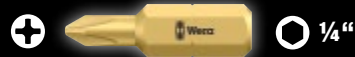

Application: Phillips screws

Drive: 1/4" hexagon, suitable for DIN 3126-D 6.3, ISO 1173 bit holders

Design: Diamond-coated for secure screw fit, profiled version

Code	+	mm	mm	mm				
05134940001	PH 1	25	1"	4.5				10
05134941001	PH 2	25	1"	6.0				10
05134942001	PH 3	25	1"	-				10

851/1 AH bits

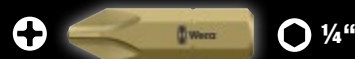

Application: Phillips screws

Drive: 1/4" hexagon, suitable for DIN 3126-D 6.3, ISO 1173 bit holders

Design: Industrial version for optimum torque transfer with increased depth of penetration into the screw recess, 1/4" hexagon over the entire bit length, robust and efficient bits for allround purposes, profiled version

Code	+	mm	mm	mm				
05380155001	PH 1	25	1"					10
05380156001	PH 2	25	1"					10
05380157001	PH 3	25	1"					10

853/1 TZ bits, ACR



Application: Phillips screws

Drive: 1/4" hexagon, suitable for DIN 3126-D 6.3, ISO 1173 bit holders

Design: Torsion-style design to reduce premature wear, tough, ideal for difficult screwdriving jobs e.g. in sheet steel or metal, ACR (Anti-Cam-Out Ribs) prevents bits from slipping out of the screw head

Code	+	mm	mm	mm				
05056660001	PH 1	25	1"					10
05056662001	PH 2	25	1"					10
05056664001	PH 3	25	1"					10



The Impaktor technology

The Impaktor technology ensures the best possible performance, even under extreme conditions, through optimization of material properties and geometry, making them ideal for use with impact drivers.



Diamond coating

Bits with a rough diamond coating on their surface, reduce the danger of cam-out, due to increased surface friction.



A stands for aviation

A bits are particularly hard bits with a sharp-edged profile which e.g. penetrates screw profiles full of paint (such as on fuselage panels) ensuring a dependable transfer of force between the bit and the screw.

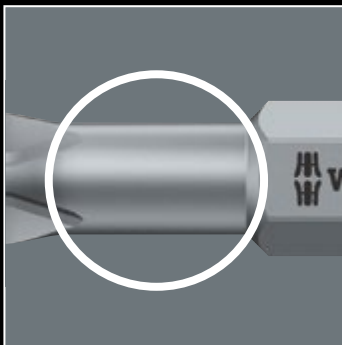

Torsion zone

Bits with a torsion zone absorb the damaging peak torque loads in the torsion zone. This prevents premature wear and enhances the service life of the bits.

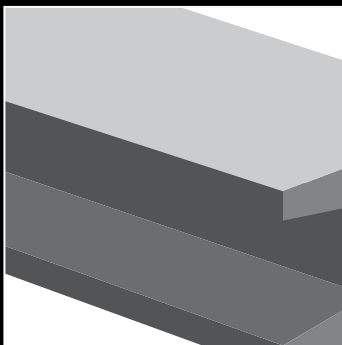

Z-bits

Z-bits are tough. Designed for use on harder materials, where bit breakage is an issue.

Bits for Phillips Screws

851/1 Z bits



Application: Phillips screws

Drive: 1/4" hexagon, suitable for DIN 3126-D 6.3, ISO 1173 bit holders

Design: Tough, ideal for difficult screwdriving jobs e.g. in sheet steel or metal

Code	+	mm	mm					
0505650001	PH 0	25	1"					10
05072070001	PH 1	25	1"					10
05056507001	PH 1	50	2"					10
05072072001	PH 2	25	1"					10
05056515001	PH 2	32	1 1/4"					10
05056520001	PH 2	50	2"					10
05072074001	PH 3	25	1"					10
05056530001	PH 3	32	1 1/4"					10
05134905001	PH 3	50	2"					10
05056535001	PH 4	32	1 1/4"					10

851/4 A bits



Application: Phillips screws

Drive: 1/4" hexagon, suitable for DIN 3126-F 6.3, ISO 1173 bit holders

Design: Robust and efficient bits for allround purposes, profiled version

Code	+	mm	mm	mm				
05134929001	PH 0	50	2"	3				10
05134906001	PH 0	70	2 3/4"	3				10
05134907001	PH 0	89	3 1/2"	3				10
05134908001	PH 0	152	6"	3				10
05134930001	PH 1	50	2"	4.5				10
05134370001	PH 1	70	2 3/4"	4.5				10
05134372001	PH 1	89	3 1/2"	4.5				10
05134909001	PH 1	152	6"	4.5				10
05134931001	PH 2	50	2"	6				10
05134371001	PH 2	70	2 3/4"	6				10
05134373001	PH 2	89	3 1/2"	6				10
05134910001 ¹⁾	PH 2	152	6"	6				10
05134911001 ²⁾	PH 2	152	6"	6				10
05134932001	PH 3	50	2"	-				10
05134912001	PH 3	50	2"	8				10
05134913001	PH 3	70	2 3/4"	8				10
05134914001	PH 3	89	3 1/2"	8				10
05134915001	PH 3	152	6"	8				10
05160983001	PH 4	50	2"	10				10

¹⁾ Length of drive 100 mm

²⁾ Length of drive 20 mm

851/4 IMP DC Impaktor bits



Application: Phillips screws

Drive: 1/4" hexagon, suitable for DIN 3126-F 6.3, ISO 1173 bit holders

Design: The Impaktor technology ensures an above-average service life even under extreme conditions thanks to a best-possible utilisation of the material properties and optimally designed geometry, particularly suitable for use with conventional impact drivers, the rough diamond coating reduces the danger of any slipping out of the screw head due to the enhanced frictional resistance

Code	+	mm	mm					
05057656001	PH 2	50	2"					5
05057657001	PH 3	50	2"					5

851/4 ADC bits



Application: Phillips screws

Drive: 1/4" hexagon, suitable for DIN 3126-F 6.3, ISO 1173 bit holders

Design: Robust and efficient bits for allround purposes, diamond-coated for secure screw fit, profiled version

Code	+	mm	mm	mm				
05134950001	PH 1	50	2"	4.5				10
05134951001	PH 2	50	2"	6				10
05134952001	PH 3	50	2"	-				10

851/4 Reduced tip bits



Application: Phillips screws

Drive: 1/4" hexagon, suitable for DIN 3126-F 6.3, ISO 1173 bit holders

Design: Reduced shaft diameter, tough, ideal for difficult access screwdriving jobs e.g. in sheet steel or metal

Code	+	mm	mm	mm				
05160899001	PH 2	50	2"	3.0				10
05160896001	PH 2	152	6"	3.0				10

851/4 RH Reduced tip bits

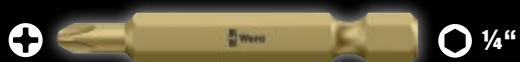

Application: Phillips screws

Drive: 1/4" hexagon, suitable for DIN 3126-F 6.3, ISO 1173 bit holders

Design: Reduced shaft diameter, robust and efficient bits for allround purposes

Code	+	mm	mm	mm				
05380160001	PH 1	50	2"	4.2				10
05380161001	PH 2	50	2"	4.2				10

851/4 Z bits



Application: Phillips screws

Drive: 1/4" hexagon, suitable for DIN 3126-F 6.3, ISO 1173 bit holders

Design: Tough, ideal for difficult screwdriving jobs e.g. in sheet steel or metal

Code	+	mm	mm	mm				
05059755001	PH 1	70	2 3/4"	4.5				10
05059760001	PH 1	89	3 1/2"	4.5				10
05059765001	PH 1	127	5"	4.5				10
05059766001	PH 1	152	6"	4.5				10
05059770001	PH 2	70	2 3/4"	6.0				10
05059775001	PH 2	89	3 1/2"	6.0				10
05059780001	PH 2	110	4 3/8"	6.0				10
05059785001	PH 2	127	5"	6.0				10
05059786001	PH 2	152	6"	6.0				10
05059790001	PH 3	70	2 3/4"	-				10
05059795001	PH 3	89	3 1/2"	-				10
05059800001	PH 3	110	4 3/8"	-				10
05059802001	PH 3	152	6"	-				10



Reduced shaft diameter

Bits with reduced shaft diameter ensure that screws can be sunk without damaging the surface.

Bits for Phillips Screws

853/4 Harpoon ACR bits



Application: Phillips screws

Drive: 1/4" hexagon, suitable for DIN 3126-F 6.3, ISO 1173 bit holders

Design: Reduced shaft diameter, tough, ideal for difficult screwdriving jobs e.g. in sheet steel or metal, ACR (Anti Cam-Out Ribs) prevents bit from slipping out of screw head

Code	+	mm	mm	mm			
05160901001	PH 2	50	2"	3.3			10
05160895001	PH 2	70	2 3/4"	3.3			10
05160908001	PH 2	152	6"	3.3			10

851/7 H bits



Application: Phillips screws

Drive: 7/16" hexagon, suitable for power tools with DIN 3126-F 11.2, ISO 1173 chuck

Design: Robust and efficient bits for allround purposes

Code	+	mm	mm	mm			
05380214001	PH 2	89	3 1/2"	6.0			5
05380215001	PH 3	89	3 1/2"	8.0			5
05380216001	PH 4	89	3 1/2"	10.0			5

853/4 ACR bits

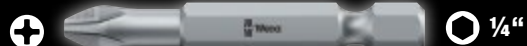

Application: Phillips screws

Drive: 1/4" hexagon, suitable for DIN 3126-F 6.3, ISO 1173 bit holders

Design: Tough, ideal for difficult screwdriving jobs e.g. in sheet steel or metal, ACR (Anti Cam-Out Ribs) prevents bit from slipping out of screw head

Code	+	mm	mm	mm			
05346285001	PH 1	50	2"	3.5			10
05346286001	PH 2	50	2"	5.2			10
05346287001	PH 3	50	2"	5.8			10

851/2 Z bits

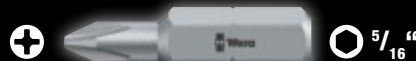

Application: Phillips screws

Drive: 5/16" hexagon, suitable for DIN 3126-D 8, ISO 1173 bit holders

Design: Tough, ideal for difficult screwdriving jobs e.g. in sheet steel or metal

Code	+	mm	mm	mm			
05057705001	PH 1	32	1 1/4"	4.5			10
05057710001	PH 2	32	1 1/4"	6.0			10
05057715001	PH 3	32	1 1/4"	7.6			10
05057720001	PH 4	32	1 1/4"	-			10
05057725001	PH 4	38	1 1/2"	10.0			10

851/25 H bits



Application: Phillips screws

Drive: 5/16" external square; special drive for direct use in 5/16" square air tools

Design: Robust and efficient bits for allround purposes

Code	+	mm	mm	mm			
05380380001	PH 1	29	1 3/16"				10
05380381001	PH 2	29	1 3/16"				10
05380382001	PH 3	29	1 3/16"				10
05380383001	PH 4	29	1 3/16"				10



ACR®-Bits:

ACR® stands for "anti-cam-out ribs". ACR® bits have ribs at the drive tip that protect against slipping out of the screw head. ACR® is a registered trademark of Phillips Screw Company.

Bits for Hexagon Socket Screws

840/1 IMP DC Impaktor bits



Application: Hexagon socket screws

Drive: 1/4" hexagon, suitable for DIN 3126-D 6.3, ISO 1173 bit holders

Design: The Impaktor technology ensures an above-average service life even under extreme conditions thanks to a best-possible utilisation of the material properties and optimally designed geometry, particularly suitable for use with conventional impact drivers, the rough diamond coating reduces the danger of any slipping out of the screw head due to the enhanced frictional resistance

Code	mm	mm	mm					
05057604001	4.0	25	1"					10
05057605001	5.0	25	1"					10
05057606001	6.0	25	1"					10

842/1 Z bits

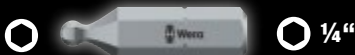

Application: Hexagon socket screws

Drive: 1/4" hexagon, suitable for DIN 3126-D 6.3, ISO 1173 bit holders

Design: Ball end, tough, ideal for difficult screwdriving jobs e.g. in sheet steel or metal

Code	mm	mm	mm					
05056350001	2.5	25	1"					10
05056352001	3.0	25	1"					10
05056354001	4.0	25	1"					10
05056356001	5.0	25	1"					10
05056358001	6.0	25	1"					10
05380103001		3/32"	25	1"				10
05380104001		7/64"	25	1"				10
05380105001		1/8"	25	1"				10
05380106001		9/64"	25	1"				10
05380107001		5/32"	25	1"				10
05380108001		3/16"	25	1"				10
05380109001		7/32"	25	1"				10
05380110001		1/4"	25	1"				10

Hex-Plus tools

Hexagon socket screws are prone to rounding out, because the typical profile attempts to transfer high torque over small, sharp edges. HexPlus tools have a unique profile that spreads those loads over larger contact points, preventing fastener damage. The best news is, Hex-Plus tools will fit any standard hex-recess fastener.

840/1 Z bits



Application: Hexagon socket screws

Drive: 1/4" hexagon, suitable for DIN 3126-D 6.3, ISO 1173 bit holders

Design: Hex-Plus, tough, ideal for difficult screwdriving jobs e.g. in sheet steel or metal

Code	mm	mm	mm					
05056303001	1.5	25	1"					10
05056305001	2.0	25	1"					10
05056310001	2.5	25	1"					10
05056315001	3.0	25	1"					10
05056320001	4.0	25	1"					10
05056325001	5.0	25	1"					10
05056330001	6.0	25	1"					10
05056332001	7.0	25	1"					10
05056335001	8.0	25	1"					10
05056340001	10.0	25	1"					10
05135060001		0.05"	25	1"				10
05135070001		1/16"	25	1"				10
05135071001		5/64"	25	1"				10
05135072001		3/32"	25	1"				10
05135078001		7/64"	25	1"				10
05135073001		1/8"	25	1"				10
05135069001		9/64"	25	1"				10
05135074001		5/32"	25	1"				10
05135075001		3/16"	25	1"				10
05135079001		7/32"	25	1"				10
05135076001		1/4"	25	1"				10
05135077001		5/16"	25	1"				10
05135068001		3/8"	25	1"				10

 **Hex-Plus Tools Available by Wera only**

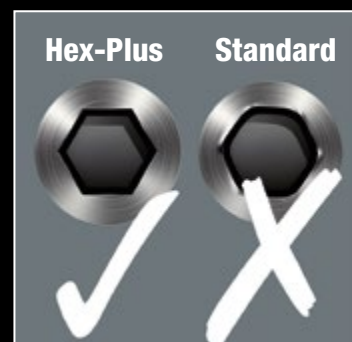

Bits for Hexagon Socket Screws

840/4 IDC Impaktor bits



Application: Hexagon socket screws

Drive: 1/4" hexagon, suitable for DIN 3126-F 6.3, ISO 1173 bit holders

Design: The Impaktor technology ensures an above-average service life even under extreme conditions thanks to a best-possible utilisation of the material properties and optimally designed geometry, particularly suitable for use with conventional impact drivers, the rough diamond coating reduces the danger of any slipping out of the screw head due to the enhanced frictional resistance

Code	mm	mm	mm					
05057644001	4.0	50	2"					5
05057645001	5.0	50	2"					5
05057646001	6.0	50	2"					5

842/4 Bits



Application: Hexagon socket screws

Drive: 1/4" hexagon, suitable for DIN 3126-F 6.3, ISO 1173 bit holders

Design: Ball end, tough, ideal for difficult screwdriving jobs e.g. in sheet steel or metal

Code	mm	mm	mm	mm				
05059680001	3.0		89	3 1/2"				5
05059681001	4.0		89	3 1/2"				5
05059682001	5.0		89	3 1/2"				5
05059683001	6.0		89	3 1/2"				5
05380124001		3/32"	89	3 1/2"				5
05380125001		7/64"	89	3 1/2"				5
05380126001		1/8"	89	3 1/2"				5
05380127001		9/64"	89	3 1/2"				5
05380128001		5/32"	89	3 1/2"				5
05380129001		3/16"	89	3 1/2"				5
05380130001		7/32"	89	3 1/2"				5
05380131001		1/4"	89	3 1/2"				5





The Impaktor technology

The Impaktor technology ensures the best possible performance, even under extreme conditions, through optimization of material properties and geometry, making them ideal for use with impact drivers.



Diamond coating

Bits with a rough diamond coating on their surface, reduce the danger of cam-out, due to increased surface friction.

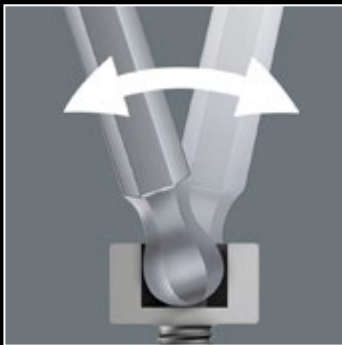

Hexagon ball tip

The ball-point tip makes it possible to work effectively, in those hard-to-reach screwdriving jobs.

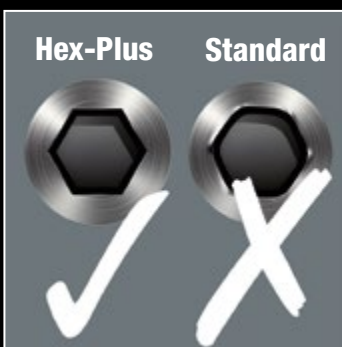

Hex-Plus tools

Hexagon socket screws are prone to rounding out, because the typical profile attempts to transfer high torque over small, sharp edges. Hex-Plus tools have a unique profile that spreads those loads over larger contact points, preventing fastener damage. The best news is, Hex-Plus tools will fit any standard hex-recess fastener.

Bits for Hexagon Socket Screws

840/4 Z bits



840/2 Z Bits



Application: Hexagon socket screws

Drive: 1/4" hexagon, suitable for DIN 3126-F 6.3, ISO 1173 bit holders

Design: Hex-Plus, tough, ideal for difficult screwdriving jobs e.g. in sheet steel or metal

Application: Hexagon socket screws

Drive: 5/16" hexagon, suitable for DIN 3126-D 8, ISO 1173 bit holders

Design: Hex-Plus, tough, ideal for difficult screwdriving jobs e.g. in sheet steel or metal

Code	mm	mm	mm	mm		
05059602001	1.5	50	2"	2.0		10
05059603001	2.0	50	2"	4.0		10
05059628001	2.0	89	3 1/2"	4.0		5
05059604001	2.5	50	2"	4.0		10
05059629001	2.5	89	3 1/2"	4.0		5
05059605001	3.0	50	2"	4.0		10
05059630001	3.0	89	3 1/2"	4.0		5
05380033001	3.0	152	6"	4.0		5
05059610001	4.0	50	2"	5.0		10
05059631001	4.0	89	3 1/2"	5.0		5
05059634001	4.0	152	6"	5.0		5
05059615001	5.0	50	2"	6.0		10
05059632001	5.0	89	3 1/2"	6.0		5
05059635001	5.0	152	6"	6.0		5
05059620001	6.0	50	2"	5.0		10
05059633001	6.0	89	3 1/2"	-		5
05059636001	6.0	152	6"	-		5
05059625001	8.0	50	2"	-		10
05135090001	1/16"	50	2"	2.5		10
05380045001	1/8"	152	6"	4.0		5
05135091001	5/64"	50	2"	3.0		10
05059660001	5/64"	89	3 1/2"	3.0		5
05135092001	3/32"	50	2"	3.0		10
05059661001	3/32"	89	3 1/2"	3.5		5
05135093001	7/64"	50	2"	3.5		10
05059662001	7/64"	89	3 1/2"	4.0		5
05135094001	1/8"	50	2"	4.0		10
05059663001	1/8"	89	3 1/2"	4.0		5
05135095001	9/64"	50	2"	4.5		10
05059664001	9/64"	89	3 1/2"	4.5		5
05380046001	9/64"	152	6"	4.5		5
05135096001	5/32"	50	2"	5.0		10
05059665001	5/32"	89	3 1/2"	5.0		5
05380047001	5/32"	152	6"	5.0		5
05135097001	3/16"	50	2"	6.0		10
05059666001	3/16"	89	3 1/2"	6.0		5
05380048001	3/16"	152	6"	6.0		5
05135098001	7/32"	50	2"	-		10
05059667001	7/32"	89	3 1/2"	-		5
05380049001	7/32"	152	6"	-		5
05135099001	1/4"	50	2"	-		10
05059668001	1/4"	89	3 1/2"	-		5
05380050001	1/4"	152	6"	-		5
05346288001	5/16"	50	2"	-		10

Code	mm	mm	mm			
05057505001	3	30	1 3/16"			10
05057510001	4	30	1 3/16"			10
05057550001	4	50	2"			10
05057560001	4	70	2"			10
05057570001	4	100	4"			10
05057515001	5	30	1 3/16"			10
05057551001	5	50	2"			10
05057561001	5	70	2 3/4"			10
05057571001	5	100	4"			10
05057520001	6	30	1 3/16"			10
05057552001	6	50	2"			10
05057562001	6	70	2 3/4"			10
05057572001	6	100	4"			10
05057553001	7	50	2"			10
05057573001	7	100	4"			10
05057525001	8	30	1 3/16"			10
05057554001	8	50	2"			10
05057563001	8	70	2 3/4"			10
05057574001	8	100	4"			10
05057530001	10	30	1 3/16"			10
05057555001	10	50	2"			10
05057575001	10	100	4"			10
05221102001	5/32"	30	1 3/16"			10
05057565001	5/32"	70	2 3/4"			10
05135083001	3/16"	30	1 3/16"			10
05135084001	7/32"	30	1 3/16"			10
05057566001	7/32"	70	2 3/4"			10
05135080001	1/4"	30	1 3/16"			10
05057567001	1/4"	70	2 3/4"			10
05135081001	5/16"	30	1 3/16"			10
05057568001	5/16"	70	2 3/4"			10
05135082001	3/8"	30	1 3/16"			10

Bits for Tamper-Proof Hexagon Socket Screws with Safety Pin

840/1 Z Tamper-proof Hex-Plus B0 bits



Application: Hexagon socket screws with safety pin (B0 = with bore hole)

Drive: 1/4" hexagon, suitable for DIN 3126-D 6.3, ISO 1173 bit holders

Design: Hex-Plus with bore hole, tough, ideal for difficult screwdriving jobs e.g. in sheet steel or metal

Code	mm	mm	mm					
05056341001	2.0	25	1"					10
05056342001	2.5	25	1"					10
05056343001	3.0	25	1"					10
05056344001	4.0	25	1"					10
05056345001	5.0	25	1"					10
05056346001	6.0	25	1"					10

840/4 Z Tamper-proof Hex-Plus B0 bits



Application: Hexagon socket screws with safety pin (B0 = with bore hole)

Drive: 1/4" hexagon, suitable for DIN 3126-F 6.3, ISO 1173 bit holders

Design: Hex-Plus with bore hole, tough, ideal for difficult screwdriving jobs e.g. in sheet steel or metal

Code	mm	mm	mm	mm				
05059640001	2.0	89	3 1/2"	4.0				5
05059641001	2.5	89	3 1/2"	4.0				5
05059642001	3.0	89	3 1/2"	4.0				5
05059643001	4.0	89	3 1/2"	5.0				5
05059644001	5.0	89	3 1/2"	6.0				5
05059645001	6.0	89	3 1/2"	-				5

Tamper-proof Hex-Plus B0 bits

These bits fit hex socket screws with a pin or post in the center of the hex recess. The internal pin requires a special insert bit, screwdriver or L-key to insert and remove. This reduces the risk of tampering by intruders undoing the screws. These screws are often referred to as Tamper Resistant, Tamper Proof, or Security Hex Screws.

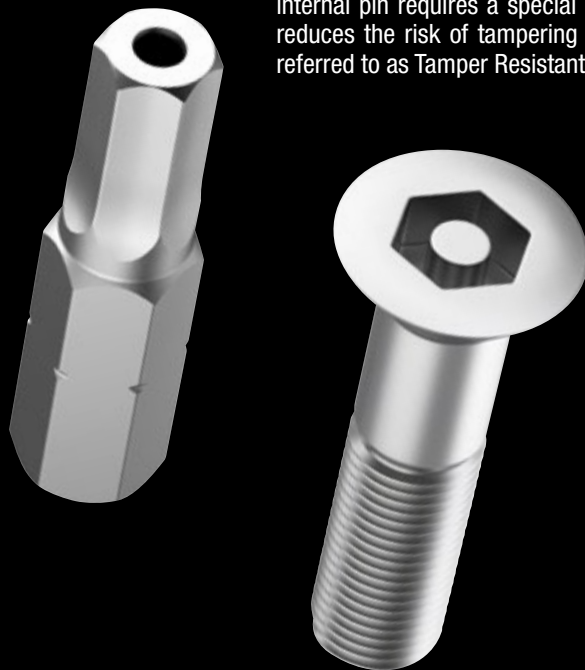

867/1 Z TORX® HF bits with holding function

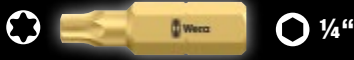

Application: TORX® socket screws made according to Acument Intellectual Properties specifications

Drive: 1/4" hexagon, suitable for DIN 3126-F 6.3, ISO 1173 bit holders

Design: Holding function for TORX® screws, tough

Code						
		mm	1"	mm		
05066070001	TX 8	25	1"	2.2		10
05066071001	TX 9	25	1"	2.4		10
05066072001	TX 10	25	1"	2.5		10
05066073001	TX 15	25	1"	3.0		10
05066074001	TX 20	25	1"	3.7		10
05066075001	TX 25	25	1"	4.1		10
05066076001	TX 27	25	1"	4.8		10
05066077001	TX 30	25	1"	5.4		10
05066078001	TX 40	25	1"	6.5		10

867/4 TORX® HF bits with holding function



Application: TORX® socket screws made according to Acument Intellectual Properties specifications

Drive: 1/4" hexagon, suitable for DIN 3126-F 6.3, ISO 1173 bit holders

Design: Holding function for TORX® screws

Code						
		mm	1"	mm		
05060080001	TX 8	50	2"	3.0		10
05060360001	TX 10	89	3 1/2"	4.0		5
05060081001	TX 10	50	2"	4.0		10
05060361001	TX 15	89	3 1/2"	4.0		5
05060082001	TX 15	50	2"	4.0		10
05060362001	TX 20	89	3 1/2"	4.5		5
05060083001	TX 20	50	2"	4.5		10
05060084001	TX 25	50	2"	6.0		10
05060363001	TX 25	89	3 1/2"	6.0		5
05060085001	TX 27	50	2"	6.0		10
05060364001	TX 27	89	3 1/2"	6.0		5
05060086001	TX 30	50	2"	6.0		10
05060365001	TX 30	89	3 1/2"	6.0		5
05060087001	TX 40	50	2"	-		10
05060366001	TX 40	89	3 1/2"	-		5



Wera TORX® HF profile

The Wera TORX® HF profile (HF = Holding Function) securely holds TORX® screws on the tool tip thanks to its drive geometry and the wedging forces associated with this. Ideal for work in difficult-to-access areas e.g. screw connections in deep blind holes.

Wera TORX® HF Profile Available by Wera only

Bits for TORX® Screws

867/1 KK TORX® bits



Application: TORX® socket screws

Drive: 1/4" hexagon, suitable for DIN 3126-D 6.3, ISO 1173 bit holders

Design: Ball end, tough

Code		mm						
05066060001	TX 10	25	1"					10
05066061001	TX 15	25	1"					10
05066062001	TX 20	25	1"					10
05066063001	TX 25	25	1"					10
05066064001	TX 30	25	1"					10
05066065001	TX 40	25	1"					10

867/4 KK TORX® bits



Application: TORX® socket screws

Drive: 1/4" hexagon, suitable for DIN 3126-F 6.3, ISO 1173 bit holders

Design: Ball end, tough

Code		mm						
05059700001	TX 10	89	3 1/2"					5
05059701001	TX 15	89	3 1/2"					5
05059702001	TX 20	89	3 1/2"					5
05059703001	TX 25	89	3 1/2"					5
05059704001	TX 30	89	3 1/2"					5
05059705001	TX 40	89	3 1/2"					5

867/1 Z TORX® bits

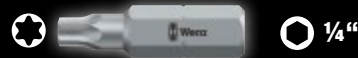

Application: TORX® socket screws

Drive: 1/4" hexagon, suitable for DIN 3126-D 6.3, ISO 1173 bit holders

Design: Tough, ideal for difficult screwdriving jobs e.g. in sheet steel or metal

Code		mm		mm				
05066492001	TX 5	25	1"	3.0				10
05066493001	TX 6	25	1"	3.0				10
05066494001	TX 7	25	1"	3.0				10
05066495001	TX 8	25	1"	3.0				10
05066496001	TX 9	25	1"	3.0				10
05066485001	TX 10	25	1"	4.0				10
05066486001	TX 15	25	1"	4.0				10
05066487001	TX 20	25	1"	5.0				10
05066488001	TX 25	25	1"	5.0				10
05066489001	TX 27	25	1"	6.0				10
05066490001	TX 30	25	1"	6.0				10
05066491001	TX 40	25	1"	-				10
05066325001	TX 45	35	1 3/8"	8.0				10
05066330001	TX 50	35	1 3/8"	9.0				10
05066335001	TX 55	35	1 3/8"	12.0				10



TORX® ball tip

The ball-point tip makes it possible to work effectively, in those hard-to-reach screwdriving jobs.

867/4 Z TORX® bits



Application: TORX® socket screws

Drive: 1/4" hexagon, suitable for DIN 3126-F 6.3, ISO 1173 bit holders

Design: Tough, ideal for difficult screwdriving jobs e.g. in sheet steel or metal

Code						
		mm	"	mm		
05135200001	TX 1	50	2"	2.0		10
05135201001	TX 2	50	2"	2.0		10
05135202001	TX 3	50	2"	2.0		10
05135204001	TX 4	50	2"	3.0		10
05135205001	TX 5	50	2"	3.0		10
05308428001	TX 6	50	2"	3.0		10
05134740001	TX 6	70	2 3/4"	3.0		10
05332600001	TX 6	89	3 1/2"	3.0		10
05328448001	TX 6	152	6"	3.0		10
05160830001	TX 7	50	2"	3.0		10
05345047001	TX 7	70	2 3/4"	3.0		10
05060131001	TX 8	50	2"	3.0		10
05060098001	TX 8	70	2 3/4"	3.0		10
05060185001	TX 8	89	3 1/2"	3.0		10
05060195001	TX 8	152	6"	3.0		10
05319835001	TX 9	70	2 3/4"	3.0		10
05060193001	TX 9	89	3 1/2"	3.0		10
05060194001	TX 9	152	6"	3.0		10
05060132001	TX 10	50	2"	4.0		10
05060100001	TX 10	70	2 3/4"	4.0		10
05060186001	TX 10	89	3 1/2"	4.0		10
05060196001	TX 10	152	6"	4.0		10
05060133001	TX 15	50	2"	4.0		10
05060105001	TX 15	70	2 3/4"	4.0		10
05060187001	TX 15	89	3 1/2"	4.0		10
05060197001	TX 15	152	6"	4.0		10
05060134001	TX 20	50	2"	4.5		10
05060110001	TX 20	70	2 3/4"	4.5		10
05060188001	TX 20	89	3 1/2"	4.5		10
05060198001	TX 20	152	6"	4.5		10
05060135001	TX 25	50	2"	6.0		10
05060115001	TX 25	70	2 3/4"	6.0		10
05060189001	TX 25	89	3 1/2"	6.0		10
05060199001	TX 25	152	6"	6.0		10
05060136001	TX 27	50	2"	6.0		10
05060120001	TX 27	70	2 3/4"	6.0		10
05060190001	TX 27	89	3 1/2"	6.0		10
05060200001	TX 27	152	6"	6.0		10
05060137001	TX 30	50	2"	6.0		10
05060191001	TX 30	89	3 1/2"	6.0		10
05060201001	TX 30	152	6"	6.0		10
05060138001	TX 40	50	2"	-		10
05060130001	TX 40	70	2 3/4"	-		10
05060192001	TX 40	89	3 1/2"	-		10
05060202001	TX 40	152	6"	-		10

867/2 Z TORX® bits



Application: TORX® socket screws

Drive: 5/16" hexagon, suitable for DIN 3126-D 8, ISO 1173 bit holders

Design: Tough, ideal for difficult screwdriving jobs e.g. in sheet steel or metal

Code						
		mm	"	mm		
05066901001	TX 20	35	1 3/8"	4.5		10
05066930001	TX 20	50	2"	4.5		10
05066945001	TX 20	70	2 3/4"	4.5		10
05066935001	TX 20	100	4"	4.5		10
05066900001	TX 25	35	1 3/8"	5.8		10
05066931001	TX 25	50	2"	5.8		10
05066946001	TX 25	70	2 3/4"	5.8		10
05066936001	TX 25	100	4"	5.8		10
05066902001	TX 27	35	1 3/8"	5.8		10
05066932001	TX 27	50	2"	5.8		10
05066937001	TX 27	100	4"	5.8		10
05066905001	TX 30	35	1 3/8"	6.0		10
05066933001	TX 30	50	2"	6.0		10
05066947001	TX 30	70	2 3/4"	6.0		10
05066938001	TX 30	100	4"	6.0		10
05066910001	TX 40	35	1 3/8"	7.0		10
05066934001	TX 40	50	2"	7.0		10
05066948001	TX 40	70	2 3/4"	7.0		10
05066939001	TX 40	100	4"	7.0		10
05066915001	TX 45	35	1 3/8"	-		10
05066940001	TX 45	50	2"	-		10
05066949001	TX 45	70	2 3/4"	-		10
05066942001	TX 45	100	4"	-		10
05066920001	TX 50	35	1 3/8"	-		10
05066941001	TX 50	50	2"	-		10
05066950001	TX 50	70	2 3/4"	-		10
05066943001	TX 50	100	4"	-		10
05066925001	TX 55	35	1 3/8"	12.0		10
05136220001	TX 60	35	1 3/8"	14.0		10

Bits for Tamper-proof TORX® BO Screws with safety pin

867/1 Z TORX® BO bits

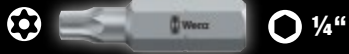

Application: TORX® socket screws with safety pin (BO = with bore hole)

Drive: 1/4" hexagon, suitable for DIN 3126-D 6.3, ISO 1173 bit holders

Design: TORX® with bore hole, tough, ideal for difficult screwdriving jobs e.g. in sheet steel or metal

Code	Icon	mm	mm					
05066497001	TX 7	25	1"					10
05066498001	TX 8	25	1"					10
05066499001	TX 9	25	1"					10
05066500001	TX 10	25	1"					10
05066505001	TX 15	25	1"					10
05066510001	TX 20	25	1"					10
05066515001	TX 25	25	1"					10
05066520001	TX 27	25	1"					10
05066525001	TX 30	25	1"					10
05066530001	TX 40	25	1"					10

867/4 Z TORX® BO bits with bore hole



Application: TORX® socket screws with safety pin (BO = with bore hole)

Drive: 1/4" hexagon, suitable for DIN 3126-F 6.3, ISO 1173 bit holders

Design: TORX® with bore hole, tough, ideal for difficult screwdriving jobs e.g. in sheet steel or metal

Code	Icon	mm	mm	mm				
05060139001	TX 8	70	2 3/4"	3.0				10
05060048001	TX 8	89	3 1/2"	3.0				10
05060049001	TX 9	89	3 1/2"	3.0				10
05060140001	TX 10	70	2 3/4"	4.0				10
05060050001	TX 10	89	3 1/2"	4.0				5
05060141001	TX 15	70	2 3/4"	4.0				10
05060051001	TX 15	89	3 1/2"	4.0				5
05060142001	TX 20	70	2 3/4"	4.5				10
05060052001	TX 20	89	3 1/2"	4.5				5
05060143001	TX 25	70	2 3/4"	6.0				10
05060053001	TX 25	89	3 1/2"	6.0				10
05060144001	TX 27	70	2 3/4"	6.0				10
05060057001	TX 27	89	3 1/2"	6.0				5
05060145001	TX 30	70	2 3/4"	6.0				10
05060054001	TX 30	89	3 1/2"	6.0				5
05060146001	TX 40	70	2 3/4"	-				10
05060056001	TX 40	89	3 1/2"	-				5



Bits for TORX PLUS® Screws





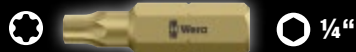

867/1 H IP TORX PLUS® bits



Application: TORX PLUS® socket screws

Drive: 1/4" hexagon, suitable for DIN 3126-D 6.3, ISO 1173 bit holders

Design: Extra-hard, ideal for less demanding screwdriving jobs e.g. in wood

Code						
		mm	1"	mm		
05135120001	IP 1	25	1"	1.5		10
05135121001	IP 2	25	1"	1.5		10
05160956001	IP 3	25	1"	2.0		10
05134695001	IP 4	25	1"	2.0		10



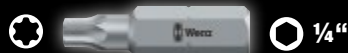

867/1 Z IP TORX PLUS® bits



Application: TORX PLUS® socket screws

Drive: 1/4" hexagon, suitable for DIN 3126-D 6.3, ISO 1173 bit holders

Design: Tough, ideal for difficult screwdriving jobs e.g. in sheet steel or metal

Code						
		mm	1"			
05066272001	5 IP	25	1"			10
05066274001	6 IP	25	1"			10
05066276001	7 IP	25	1"			10
05066278001	8 IP	25	1"			10
05066279001	9 IP	25	1"			10
05066280001	10 IP	25	1"			10
05066282001	15 IP	25	1"			10
05066284001	20 IP	25	1"			10
05066286001	25 IP	25	1"			10
05066287001	27 IP	25	1"			10
05066288001	30 IP	25	1"			10
05066290001	40 IP	25	1"			10

Bits for Tamper-proof TORX PLUS® IPR Screws

867/1 IPR TORX PLUS® bits with bore hole



Application: TORX PLUS® IPR socket screws with safety pin

Drive: 1/4" hexagon, suitable for DIN 3126-D 6.3, ISO 1173 bit holders

Design: Tough, ideal for difficult screwdriving jobs e.g. in sheet steel or metal

Code	IPR	mm	mm						
05134699001	8 IPR	25	1"						10
05134698001	9 IPR	25	1"						10
05134700001	10 IPR	25	1"						10
05134701001	15 IPR	25	1"						10
05134702001	20 IPR	25	1"						10
05134703001	25 IPR	25	1"						10
05134704001	27 IPR	25	1"						10
05134705001	30 IPR	25	1"						10
05134706001	40 IPR	35	1 3/8"						10
05134707001	45 IPR	35	1 3/8"						10

867/4 IPR TORX PLUS® bits with bore hole



Application: TORX PLUS® IPR socket screws with safety pin

Drive: 1/4" hexagon, suitable for DIN 3126-F 6.3, ISO 1173 bit holders

Design: Tough, ideal for difficult screwdriving jobs e.g. in sheet steel or metal

Code	IPR	mm	mm	mm					
05160821001	10 IPR	50	2"	4.0					10
05134657001	10 IPR	89	3 1/2"	4.0					10
05134654001	15 IPR	50	2"	4.0					10
05134720001	15 IPR	89	3 1/2"	4.0					10
05204126001	20 IPR	50	2"	4.5					10
05259135001	20 IPR	89	3 1/2"	4.5					10
05134655001	25 IPR	50	2"	6.0					10
05134722001	25 IPR	89	3 1/2"	6.0					10
05134656001	27 IPR	50	2"	6.0					10
05134658001	27 IPR	89	3 1/2"	6.0					10
05134732001	30 IPR	50	2"	6.0					10
05134723001	30 IPR	89	3 1/2"	6.0					10

TORX PLUS® Bits — Tamper Proof

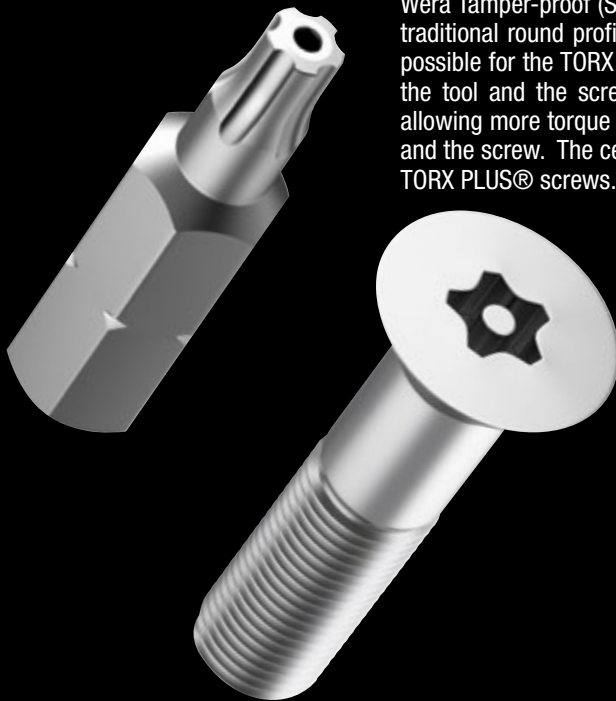

Wera Tamper-proof (Security) TORX PLUS® IPR Bits have a more elliptical profile than the traditional round profile that the standard Tamper-proof TORX® bits have. This makes it possible for the TORX PLUS® tools to increase the flanks that transfer the torque between the tool and the screw. The force applied is distributed across a larger surface area allowing more torque to be transferred and extends the service life of the TORX PLUS® bit and the screw. The center bore hole allows for fastening and unfastening of Tamper Proof TORX PLUS® screws. This reduces the risk of tampering by intruders undoing the screws.

Attention:

TORX PLUS® IPR is a safety profile – sold only to authorised customers. Such authorisation has to be proven in writing.

Bits for TORQ-SET® Screws

871/1 DC TORQ-SET® Mplus bits

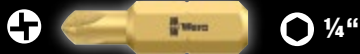

Application: TORQ-SET® screws

Drive: 1/4" hexagon, suitable for DIN 3126-D 6.3, ISO 1173 bit holders

Design: Mplus for higher breaking torque and longer service life, diamond-coated for secure screw fit

Code	mm	mm	mm	mm		
05066640001	6	25	1"	4.7		10
05066642001	8	25	1"	6.0		10
05066644001	10	25	1"	6.0		10
05066646001	6	1/4"	32	1 1/4"	11.0	10

871/4 DC TORQ-SET® Mplus bits

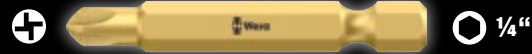

Application: TORQ-SET® screws

Drive: 1/4" hexagon, suitable for DIN 3126-F 6.3, ISO 1173 bit holders

Design: Mplus for higher breaking torque and longer service life, diamond-coated for secure screw fit

Code	mm	mm	mm			
05066690001	6	50	2"			10
05066692001	8	50	2"			10
05066694001	10	50	2"			10
05066696001	1/4"	50	2"			10

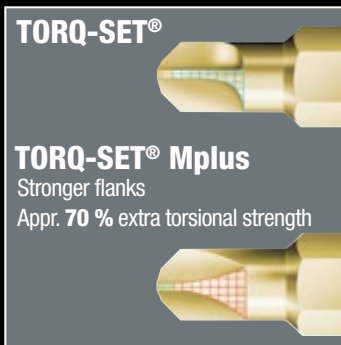
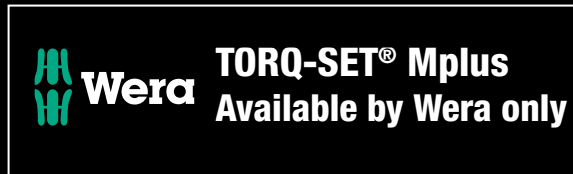

TORQ-SET® Mplus

Wera developed the Mplus profile with stronger flanks compared to tools with a conventional TORQ-SET® profile. This results in approximately 70 % extra torsional strength and greatly extends the service life of Wera Mplus tools.

The best choice to remove seized or damaged screws is the Diamond coated design of the Wera TORQ-SET® Mplus profile. The diamond particles bite securely into the head of the screw and therefore guarantee secure positioning. As a result, the damaging cam-out forces are greatly reduced.



Diamond coating

Bits with a rough diamond coating on their surface, reduce the danger of cam-out, due to increased surface friction.

Bits for TORQ-SET® Screws

871/1 TORQ-SET® Mplus bits, 25 mm



Application: TORQ-SET® screws

Drive: 1/4" hexagon, suitable for DIN 3126-D 6.3, ISO 1173 bit holders

Design: Mplus for higher breaking torque and longer service life, tough, ideal for difficult screwdriving jobs e.g. in sheet steel or metal

Code	mm	mm	mm	mm		
05066618001	0	25	1"	4.7		10
05066619001	1	25	1"	4.7		10
05066620001	2	25	1"	4.7		10
05066622001	3	25	1"	4.7		10
05066624001	4	25	1"	4.7		10
05066626001	5	25	1"	4.7		10
05066628001	6	25	1"	4.7		10
05066630001	8	25	1"	6.0		10
05066632001	10	25	1"	6.0		10
05066633001	1/4"	25	1"	6.0		10

871/1 TORQ-SET® Mplus bits, 32 mm



Application: TORQ-SET® screws

Drive: 1/4" hexagon, suitable for DIN 3126-D 6.3, ISO 1173 bit holders

Design: Mplus for higher breaking torque and longer service life, tough, ideal for difficult screwdriving jobs e.g. in sheet steel or metal

Code	mm	mm	mm			
05066634001	1/4"	32	1 1/4"	11.0		10
05066635001	5/16"	32	1 1/4"	11.0		10



871/4 TORQ-SET® Mplus bits

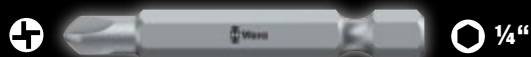

Application: TORQ-SET® screws

Drive: 1/4" hexagon, suitable for DIN 3126-F 6.3, ISO 1173 bit holders

Design: Mplus for higher breaking torque and longer service life

Code	mm	mm	mm				
05066660001	2	50	2"				10
05066683001	2	89	3 1/2"				5
05066662001	3	50	2"				10
05066684001	3	89	3 1/2"				5
05066664001	4	50	2"				10
05066685001	4	89	3 1/2"				5
05066666001	5	50	2"				10
05066668001	6	50	2"				10
05066676001	6	70	2 3/4"				5
05066686001	6	89	3 1/2"				10
05066670001	8	50	2"				10
05066678001	8	70	2 3/4"				5
05066687001	8	89	3 1/2"				10
05066672001	10	50	2"				10
05066680001	10	70	2 3/4"				5
05066682001	10	89	3 1/2"				5
05066674001	2	1/4"	50	2"			10
05221110001	2	5/16"	50	2"			10

871/2 TORQ-SET® Mplus bits



Application: TORQ-SET® screws

Drive: 5/16" hexagon, suitable for DIN 3126-D 8, ISO 1173 bit holders

Design: Mplus for higher breaking torque and longer service life, tough, ideal for difficult screwdriving jobs e.g. in sheet steel or metal

Code	mm	mm	mm				
05066650001	8	32	1 1/4"				5
05066652001	10	32	1 1/4"				5
05066654001	1/4"	32	1 1/4"				5
05066656001	5/16"	32	1 1/4"				5
05066658001	3/8"	32	1 1/4"				5

871/6 TORQ-SET® Mplus bits



Application: TORQ-SET® screws

Drive: 5/16" hexagon, suitable for DIN 3126-F 8, ISO 1173 bit holders

Design: Mplus for higher breaking torque and longer service life

Code	mm	mm	mm	mm			
05066700001	8	35	1 3/8"	6.0			5
05066702001	10	35	1 3/8"	6.0			5
05066704001	1/4"	35	1 3/8"	11.0			5

871/7 TORQ-SET® Mplus bits



Application: TORQ-SET® screws

Drive: 7/16" hexagon, suitable for power tools with DIN 3126-F 11,2, ISO 1173 chuck

Design: Mplus for higher breaking torque and longer service life

Code	mm	mm	mm				
05066740001	1/4"	35	1 3/8"	11.0			5
05066742001	5/16"	35	1 3/8"	11.0			5
05066744001	3/8"	35	1 3/8"	11.0			5
05066746001	7/16"	35	1 3/8"	11.0			5

871/19 TORQ-SET® Mplus bits



Application: TORQ-SET® screws

Drive: 5/8" hexagon

Design: Mplus for higher breaking torque and longer service life

Code	mm	mm					
05066750001	1/2"	40	1 9/16"				5
05066752001	9/16"	40	1 9/16"				5
05066754001	5/8"	40	1 9/16"				5

Bits for TRI-WING® Screws

875/1 TRI-WING® bits, 25 mm

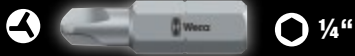

Application: TRI-WING® screws

Drive: 1/4" hexagon, suitable for DIN 3126-D 6.3, ISO 1173 bit holders

Design: Tough, ideal for difficult screwdriving jobs e.g. in sheet steel or metal

Code	Icon	mm	mm	mm	mm	mm	mm	mm	mm	Icon
05066758001	0	25	1"	4.7						10
05066760001	1	25	1"	4.7						10
05066762001	2	25	1"	4.7						10
05066764001	3	25	1"	4.7						10
05066766001	4	25	1"	6.2						10
05066768001	5	25	1"	6.2						10

875/4 TRI-WING® bits



Application: TRI-WING® screws

Drive: 1/4" hexagon, suitable for DIN 3126-F 6.3, ISO 1173 bit holders

Design: Tough, ideal for difficult screwdriving jobs e.g. in sheet steel or metal

Code	Icon	mm	mm	mm	mm	mm	mm	mm	mm	Icon
05066785001	1	89	3 1/2"							5
05066786001	2	89	3 1/2"							5
05066787001	3	89	3 1/2"							5
05066780001	4	50	2"							10
05066788001	4	89	3 1/2"							5
05066782001	5	50	2"							10
05066784001	6	50	2"							10

875/1 TRI-WING® bits, 32 mm



Application: TRI-WING® screws

Drive: 1/4" hexagon, suitable for DIN 3126-D 6.3, ISO 1173 bit holders

Design: Tough, ideal for difficult screwdriving jobs e.g. in sheet steel or metal

Code	Icon	mm	mm	mm	mm	mm	mm	mm	mm	Icon
05066770001	6	32	1 1/4"	11.0						10
05066772001	7	32	1 1/4"	11.0						10
05066774001	8	32	1 1/4"	12.5						10

875/6 TRI-WING® bits

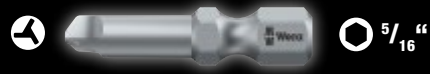

Application: TRI-WING® screws

Drive: 5/16" hexagon, suitable for DIN 3126-F 8, ISO 1173 bit holders

Design: Tough, ideal for difficult screwdriving jobs e.g. in sheet steel or metal

Code	Icon	mm	mm	mm	mm	mm	mm	mm	mm	Icon
05066790001	6	35	1 3/8"	11.0						5
05066792001	7	35	1 3/8"	11.0						5
05066794001	8	35	1 3/8"	12.5						5



TRI-WING® tamper resistant

For applications that require screws to be securely torqued, and that require tamper-resistance, the TRI-WING® system is a good choice. The unique design makes removal without the correct tools, almost impossible.

Bits for Hi-TORQUE Screws

800/1 HTN Hi-TORQUE bits



Application: Hi-TORQUE screws

Drive: 1/4" hexagon, suitable for DIN 3126-D 6.3, ISO 1173 bit holders

Code	Drive	Length (mm)	Length (in)	Weight (g)	Weight (oz)	Material	Quantity
05055950001	1	32	1 1/4"				5
05055951001	2	32	1 1/4"				5
05055952001	3	32	1 1/4"				5
05055953001	4	32	1 1/4"				5

700 B HTS Hi-TORQUE bits



Application: For Hi-TORQUE screws

Drive: 3/8"-square drive socket

Code	Drive	Length (mm)	Length (in)	Weight (g)	Weight (oz)	Material	Quantity
05040040001	3	25	1"				5
05040041001	4	25	1"				5
05040042001	5	32	1 1/4"				5
05040043001	6	32	1 1/4"				5

700 A HTS Hi-TORQUE bits



Application: For Hi-TORQUE screws

Drive: 1/4"-square drive socket

Code	Drive	Length (mm)	Length (in)	Weight (g)	Weight (oz)	Material	Quantity
05040030001	0	25	1"				5
05040031001	1	25	1"				5
05040032001	2	25	1"				5
05040033001	3	25	1"				5
05040034001	4	25	1"				5

700 C HTS Hi-TORQUE bits



Application: For Hi-TORQUE screws

Drive: 1/2"-square drive socket

Code	Drive	Length (mm)	Length (in)	Weight (g)	Weight (oz)	Material	Quantity
05040045001	7	42	1 5/8"				5
05040046001	8	42	1 5/8"				5
05040047001	9	42	1 5/8"				5
05040048001	10	42	1 5/8"				5
05040049001	12	60	2 3/8"				5

Hi-Torque

Hi-Torque screws provide the optimum in maintenance efficiency where repeated installation and removal of high strength fasteners are encountered. Hi-Torque's built-in reliability means confidence in the capacity to match aerospace concepts of today and for the future.

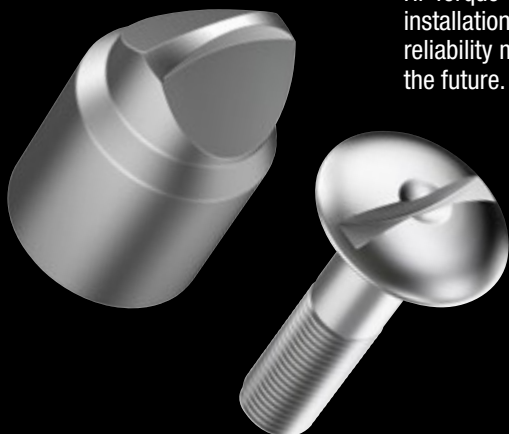

Impaktor Bit Holder

For an above-average service life

897/4 IMP R Impaktor holder with retaining ring and ring magnet

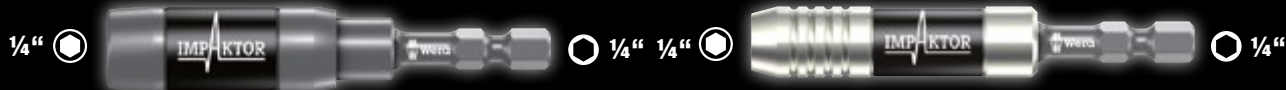

Impaktor holder to cushion extreme impulse peaks, special torsion effect from the double-torsion spring, equipped with a ring magnet to easily hold longer and heavier screws, also ideal for above-head work, particularly suitable for use with impact drivers, the magnet can be retracted and in this way be disabled

Output: Suitable for bits with 1/4" hexagon head drive as per DIN 3126-C 6.3 and Wera Series 1

Design: The Impaktor technology ensures an above-average service life even under extreme conditions thanks to a best-possible utilisation of the material properties and optimally designed geometry (two coupled torsion zones that perform successively), fitted with retaining ring and ring magnet

Drive: 1/4" hexagon, suitable for power driven screwdrivers with DIN 3126-F 6.3, ISO 1173 chucks

Code						
Code	mm	mm	mm	mm	mm	mm
05057676001	1/4"	75	3"	1/4"		5

897/4 IMP Impaktor holder with retaining ring and magnet



Impaktor holder to cushion extreme impulse peaks, special torsion effect from the double-torsion spring, equipped with a retaining ring for a secure fit of the bits in the holder, holder out of stainless steel, fitted with magnet for a secure positioning of the bit and screw.

Output: Suitable for bits with 1/4" hexagon head drive as per DIN 3126-C 6.3 and Wera Series 1

Design: The Impaktor technology ensures an above-average service life even under extreme conditions thanks to a best-possible utilisation of the material properties and optimally designed geometry (two coupled torsion zones that perform successively), fitted with strong retaining ring and magnet

Drive: 1/4" hexagon, suitable for power driven screwdrivers with DIN 3126-F 6.3, ISO 1173 chucks

Code						
Code	mm	mm	mm	mm	mm	mm
05057675001	1/4"	75	3"	1/4"		5



Impaktor holder with ring magnet

The Impaktor holder with ring magnet securely holds longer and heavier screws with ease. This helps to ensure faster and more reliable screw positioning. The extra hold is also ideal for over-head work. Should the magnet function not be required in a particular situation e.g. when working with metal, it can be extracted from the screwdriving area and can thereby be "disabled".



Impaktor stainless steel holder

The Impaktor stainless steel holder, uses a retaining ring and magnet, to withstand the toughest fastening applications. This unique design has no small mechanical parts, so it is less prone to failure. In addition, it's 2 different torsion zones cushion extreme torque peaks, providing longer service life for the bits.

Rapidaptor Bit Holder

For rapid bit changes

889/4/1 K Rapidaptor Universal Bit Holder



Wera Rapidaptor holders
Available by Wera only

Application: Suitable for 1/4" DIN 3126-C 6,3 and E 6,3 (ISO 1173) hexagon insert bits and Wera Series 1 and 4

Design: Rapidaptor rapid-in, rapid-out, rapid-spin, chuck-all, and single-hand technology, with strong permanent magnet

Drive: 1/4" hexagon suitable for power tools with DIN 3126-F 6,3, ISO 1173 receiver

Code						
	1/4"	mm	2"	1/4"	mm	5
05052502001	1/4"	50	2"	1/4"	15.0	5



Chuck-all – Flexibility

The Rapidaptor quick-release chucks hold both 1/4" bits as per DIN 3126-C 6.3 (Wera series 1) and E 6.3 (Wera series 4).



Rapid-in, self-locking, and free-spinning

The bit can be pushed into the chuck without moving the sleeve. It automatically locks with a secure and wobble-free fit as soon as the bit is applied to the screw. Rapid bit change without additional tools. Single-hand operation. Free-turning sleeve allows screw steadying at the start of the screwdriving process. Can also be used as a short extension.



Rapid-out – Easy bit changes

Simply push the sleeve forward to change the bit. The spring mechanism lifts the bit off the magnet and unlocks the tool. The bit can be easily removed. Particularly helpful: even the smallest bits can be removed without any extra tools.

Universal Bit Holder with Stainless Steel Sleeve

Strong magnet for secure hold





899/4/1 S Universal Bit Holder with strong retaining ring



Application: Suitable for 1/4" DIN 3126-C 6,3 (ISO 1173) hexagon insert bits and Wera Series 1

Design: With stainless steel sleeve, strong retaining ring, and strong permanent magnet

Drive: 1/4" hexagon, suitable for power tools with DIN 3126-F 6,3, ISO 1173 receiver

Code	1/4" 	mm	1/4" 	mm			
05160976001	1/4"	50	2"	10.5	1/4"	10.5	5
05160924001	1/4"	75	3"	10.5	1/4"	10.5	5
05160977001	1/4"	100	4"	10.5	1/4"	10.5	5
05160978001	1/4"	152	6"	10.5	1/4"	10.5	5
05160979001	1/4"	200	8"	10.5	1/4"	10.5	2
05160980001	1/4"	250	10"	10.5	1/4"	10.5	2
05160981001	1/4"	300	12"	10.5	1/4"	10.5	2

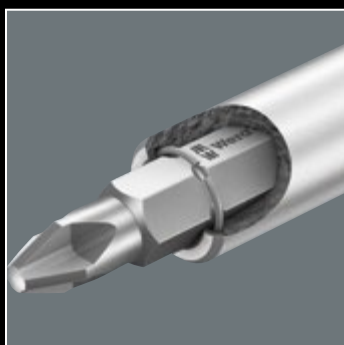

Universal Bit Holder with Stainless Steel Sleeve

With stainless steel sleeve, strong retaining ring, and strong permanent magnet. The retaining ring is a tried and tested adapter shape that ensures that the tool is held firmly in the holder.



Adaptors with quick-release chuck



Adaptors



784 A 1/4" Adaptor with quick-release chuck



Application: Suitable for 1/4" DIN 3126-C 6,3 (ISO 1173) hexagon insert bits and Wera Series 1

Design: With Wera quick-release chuck

Drive: 1/4" female square

Code	Art.No.					
Code	Art.No.	mm	mm			
05042750001	784 A/1	1/4"	30	1 3/16"	1/4"	5





784 B 3/8" Adaptors with quick-release chuck



Application: Suitable for 1/4" DIN 3126-C 6,3 and 5/16" DIN 3126-C 8 (ISO 1173) hexagon insert bits and Wera Series 1 and 2

Design: With Wera quick-release chuck

Drive: 3/8" female square

Code	Art.No.					
Code	Art.No.	mm	mm			
05042755001	784 B/1	1/4"	43	1 5/8"	3/8"	5
05042765001	784 B/2	5/16"	50	2"	3/8"	5





784 C 1/2" Adaptors with quick-release chuck



Application: Suitable for 1/4" DIN 3126-C 6,3 and 5/16" DIN 3126-C 8 (ISO 1173) hexagon insert bits and Wera Series 1 and 2

Design: With Wera quick-release chuck

Drive: 1/2" female square

Code	Art.No.					
Code	Art.No.	mm	mm			
05042760001	784 C/1	1/4"	50	2"	1/2"	5
05042768001	784 C/2	5/16"	50	2"	1/2"	5

Joker Combination ratchet wrenches







Do it all. Better.

Joker Ratcheting combination wrenches



Application: Hexagonal nuts or bolts

Design: Ratcheting combination wrench; unique holding function, thanks to the metal plate in the jaw, reduces the risk of dropping nuts and bolts; replaceable metal plate in the jaw secures nuts and bolts with its extra hard teeth and reduces the danger of slipping; integrated limit stop prevents any slipping around the bolt head and allows higher torque to be applied; double-hex geometry makes for a positive connection with nuts or bolts and reduces the risk of slipping; return angle of only 30° at the open end to avoid time consuming flipping of the wrench during fastening jobs; ratchet mechanism at the ring end, with an exceptional, fine-tooth mechanism – 80 teeth in all – enables flexibility in very confined working spaces; specially forged geometry for high torque transfer and strength; high performance chrome molybdenum steel; nickel-chrome coating for high corrosion protection.

Code	 mm	 mm	 mm	 mm	 mm	 mm	
05073268001	8	144	20	5.5	18	7	3
05073270001	10	159	22	5.5	21	7.2	3
05073271001	11	165.0	25	6.3	22	7.5	3
05073272001	12	170.7	26.3	6.6	25	8.5	3
05073273001	13	177	27.3	7	25	8.6	3
05073274001	14	188	29.3	7.5	28	9.2	3
05073275001	15	200	32.3	7.8	28.5	9.2	3
05073276001	16	212	35	8.2	32.7	10.5	3
05073277001	17	224	37.2	8.5	32.7	10.5	3
05073278001	18	235	39	9	33.8	11	3
05073279001	19	246	42	9.5	34.8	11	3
05073280001	5/16"	144	20	5.5	18	7	3
05073281001	3/8"	159	22	5.5	21	7.2	3
05073282001	7/16"	165.0	25	6.3	22	7.5	3
05073283001	1/2"	177	27.3	7	25	8.6	3
05073284001	9/16"	188	29.3	7.5	28	9.2	3
05073285001	5/8"	212	35	8.2	32.7	10.5	3
05073286001	11/16"	235	39	9	33.8	11	3
05073287001	3/4"	246	42	9.5	34.8	11	3



Wera Joker
Available by Wera only





Holding function

The Joker's holding function means that nuts and bolts can be held in the jaw and easily positioned where they are needed. Fastening on to the thread can then be done quickly and safely, thanks to the innovative special stop-plate which holds the fastener. No more time-wasting searches for dropped nuts and bolts! After applying and positioning the nut or bolt, fastening can begin immediately – no additional tools required.



Secure grip on fasteners

Constant re-positioning of the wrench? Difficulty holding fasteners in confined spaces? Easing off to avoid any risks of injury or fastener damage? That was yesterday. Today, the Joker prevents slipping off of the fastener head with its integrated limit-stop – no longer is the thumb needed to act as a depth stop. This makes applications much easier and allows significantly more force to be applied during fastening jobs.



Very small return angle

Less can be more. Particularly in those very confined spaces, where conventional wrenches with a 60° return angle have to be turned over and over, to tighten and loosen nuts or bolts. Instead of 60°, the Joker only has a 30° return angle thanks to its unique double-hex design. Along with the Joker's straight neck, this means that flipping the wrench has become a thing of the past. With the Joker, you can now loosen and tighten nuts and bolts, in situations where conventional tools fail. Particularly in confined spaces.



Anti-slip effect

The Joker's clever double-hex geometry delivers a very positive connection with nuts or bolts – it's a perfect fit. And the exchangeable, hardened metal gripping plate in the Joker's mouth literally bites itself into the bolt, with its extremely hard tips. Both features combine to prevent slipping, even at higher torque.



Fine tooth mechanism

The Joker performs fastening jobs in almost every conceivable situation, quickly and with great precision. The ratcheting feature at the ring end boasts an exceptional, fine tooth mechanism – 80 teeth in all – which provides greater flexibility, even in very confined working spaces.

Joker Set of ratcheting combination wrenches



Set of ratcheting combination wrenches
11-piece set
Durable pouch

Application: Hexagonal nuts or bolts

Design: Ratcheting combination wrench; unique holding function, thanks to the metal plate in the jaw, reduces the risk of dropping nuts and bolts; replaceable metal plate in the jaw secures nuts and bolts with its extra hard teeth and reduces the danger of slipping; integrated limit stop prevents any slipping around the bolt head and allows higher torque to be applied; double-hex geometry makes for a positive connection with nuts or bolts and reduces the risk of slipping; return angle of only 30° at the open end to avoid time consuming flipping of the wrench during fastening jobs; ratchet mechanism at the ring end, with an exceptional, fine-tooth mechanism – 80 teeth in all – enables flexibility in very confined working spaces; specially forged geometry for high torque transfer and strength; high performance chrome molybdenum steel; nickel-chrome coating for high corrosion protection.

Code			
05020013001	Joker	1 x 8x144; 1 x 10x159; 1 x 11x165.0; 1 x 12x170.7; 1 x 13x177; 1 x 14x188; 1 x 15x200; 1 x 16x212; 1 x 17x224; 1 x 18x235; 1 x 19x246	1

Joker Set of ratcheting combination wrenches, imperial



Set of ratcheting combination wrenches
8-piece set
Most popular sizes
Durable pouch

Application: Hexagonal nuts or bolts

Design: Ratcheting combination wrench; unique holding function, thanks to the metal plate in the jaw, reduces the risk of dropping nuts and bolts; replaceable metal plate in the jaw secures nuts and bolts with its extra hard teeth and reduces the danger of slipping; integrated limit stop prevents any slipping around the bolt head and allows higher torque to be applied; double-hex geometry makes for a positive connection with nuts or bolts and reduces the risk of slipping; return angle of only 30° at the open end to avoid time consuming flipping of the wrench during fastening jobs; ratchet mechanism at the ring end, with an exceptional, fine-tooth mechanism – 80 teeth in all – enables flexibility in very confined working spaces; specially forged geometry for high torque transfer and strength; high performance chrome molybdenum steel; nickel-chrome coating for high corrosion protection.

Code			
05020012001	Joker inch	1 x 5/16"x144; 1 x 3/8"x159; 1 x 7/16"x165.0; 1 x 1/2"x177; 1 x 9/16"x188; 1 x 5/8"x212; 1 x 11/16"x235; 1 x 3/4"x246	1





The Zyklop Ratchets Range

Ratchets reinvented

Zyklop Speed

5 types of ratchets in 1 tool



The Zyklop Speed is particularly impressive because it combines 5 types of ratchet into a single tool, and delivers the fastest working speeds. Both features result in making work simpler, and saving time.

Zyklop Metal

with push-through square drive



The Zyklop Metal ratchets are solid chrome-moly steel. Light and strong. The unique push-through square drive cannot come loose from the ratchet, and cannot accidentally change direction. In addition, the secure socket-lock mechanism keeps a solid connection to sockets and accessories.

Zyklop Metal

with switch lever



Textile boxes

for improved portability



The Zyklop Metal ratchets with switch lever are made completely of metal. The switch lever allows for convenient change of direction. As with all Zyklop ratchets, the Zyklopp Metal ratchets with switch lever feature a secure socket locking function.

Wera has developed a completely new "set concept". The completely new textile boxes offer dramatically improved portability, and are space-saving to boot! This means you can now carry the same collection of tools, in a much more compact and comfortable package.

The much lower weight of a set makes carrying more convenient than ever before. The textile box including the tool will even survive a fall undamaged. And: it leaves absolutely no signs of scratches on sensitive surfaces.

The Zyklop Speed Ratchets, 1/4"

Combining 5 types of ratchet

8000 A Zyklop Speed ratchet with 1/4" drive

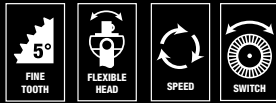

Application: 1/4" square sockets and 1/4" adaptors with square drive, equipped with ball lock

Design: Flywheel design and easy-to-grip free-turning sleeve for faster work, swivel ratchet head, defined lock positions at 0° and 90° to the left and right as well as at 15° before 90° inwards, at 0° it can be used like a conventional screwdriver, pushbutton release, left/right switchover, fine-tooth design, small return angle of 5°

Handle: Multi-component Kraftform handle ensures minimum fatigue

Code	mm								
05003500001	1/4"	152.0							1

8100 SA 2 Zyklop Speed ratchet set, 1/4" drive, metric

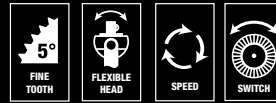

42-piece set in strong metal case

1 Zyklop ratchet with 1/4" drive, 13 Zyklop sockets (metric), 2 Zyklop „flexible-lock“ extensions (short and long) with free-turning sleeve, 1 wobble extension, 1 sliding T-handle, 1 universal joint, 1 adaptor with quick-release chuck, 22 bits



Wera Zyklop Ratchets
Available by Wera only

Code			
05003533001	8000 A	1 x 1/4"x152.0	1
	8790 HMA	1 x 4.0x23.0; 1 x 4.5x23.0; 1 x 5.0x23.0; 1 x 5.5x23.0; 1 x 6.0x23.0; 1 x 7.0x23.0; 1 x 8.0x23.0; 1 x 9.0x23.0; 1 x 10.0x23.0; 1 x 11.0x23.0; 1 x 12.0x23.0; 1 x 13.0x23.0; 1 x 14.0x23.0	
	8789 A	1 x 1/4"x110.0	
	8794 A	1 x 1/4"x56.0	
	8795 A	1 x 1/4"x35.5	
	8784 A1	1 x 1/4"x1/4"x37.0	
	8796 SA	1 x 1/4"x75.0	
	8796 LA	1 x 1/4"x150.0	
	840/1 Z Hex-Plus	1 x 3.0x25; 1 x 4.0x25; 1 x 5.0x25; 1 x 6.0x25; 1 x 8.0x25	
	867/1 Z TORX® BO	1 x TX 8x25; 1 x TX 9x25; 1 x TX 10x25; 1 x TX 15x25; 1 x TX 20x25; 1 x TX 25x25; 1 x TX 30x25; 1 x TX 40x25	
	800/1 Z	1 x 0.6x4.5x25; 1 x 1.0x5.5x25; 1 x 1.2x8.0x25	
	851/1 Z PH	1 x PH 1x25; 1 x PH 2x25; 1 x PH 3x25	
	855/1 Z PZ	1 x PZ 1x25; 1 x PZ 2x25; 1 x PZ 3x25	



Fast mover

The Zyklop ratchets are really fast movers. The gyrating mass design means that screwdriving is accelerated. The rotation-symmetric structure of the Kraftform handle and the free-turning sleeve reinforce this rapid twisting process, particularly when the ratchet does not engage because of insufficient resistance in the thread.

8100 SA 4 Zyklop Speed ratchet set, 1/4" drive, imperial

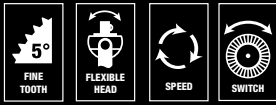

41-piece set in strong metal case

1 Zyklop ratchet with 1/4" drive, 10 Zyklop sockets (imperial), 2 Zyklop „flexible-lock“ extensions (short and long) with free-turning sleeve, 1 wobble extension, 1 sliding T-handle, 1 universal joint, 1 adaptor with quick-release chuck, 24 bits

Code			
05003535001	8000 A	1 x 1/4"x152.0	1
	8790 HMA	1 x 3/16"x23.0; 1 x 7/32"x23.0; 1 x 1/4"x23.0; 1 x 9/32"x23.0; 1 x 5/16"x23.0; 1 x 11/32"x23.0; 1 x 3/8"x23.0; 1 x 7/16"x23.0; 1 x 1/2"x23.0; 1 x 9/16"x23.0	
	8789 A	1 x 1/4"x110.0	
	8794 A	1 x 1/4"x56.0	
	8795 A	1 x 1/4"x35.5	
	8784 A1	1 x 1/4"x1/4"x37.0	
	8796 SA	1 x 1/4"x75.0	
	8796 LA	1 x 1/4"x150.0	
	867/1 Z TORX® B0	1 x TX 8x25; 1 x TX 9x25; 1 x TX 10x25; 1 x TX 15x25; 1 x TX 20x25; 1 x TX 25x25; 1 x TX 30x25; 1 x TX 40x25	
	800/1 Z	1 x 0.6x4.5x25; 1 x 1.0x5.5x25; 1 x 1.2x8.0x25	
	851/1 Z PH	1 x PH 1x25; 1 x PH 2x25; 1 x PH 3x25	
	855/1 Z PZ	1 x PZ 1x25; 1 x PZ 2x25; 1 x PZ 3x25	
	840/1 Z Hex- Plus	1 x 5/64"x25; 1 x 3/32"x25; 1 x 1/8"x25; 1 x 9/64"x25; 1 x 5/32"x25; 1 x 3/16"x25; 1 x 7/32"x25	



Pivoting head

The ratchet head pivots freely and can be locked into any position by using the slide switch that is positioned on either side. It is even possible to work in very confined and difficult-to-access areas with enhanced hand clearance. The predefined locking at 0°, 15° and 90°, both to the right and left, ensure safe working without any slipping of the ratchet head.



Low return angle

The reversible ratchet with 72 fine-pitched teeth has a low return angle of only 5°. This short stroke allows fast and precise work in all types of installation.

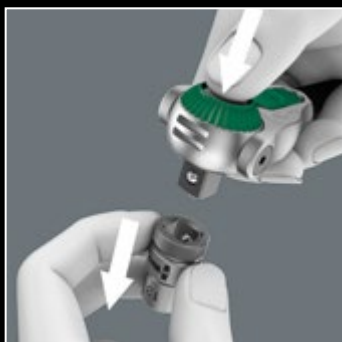

Ball lock

The ball lock holds the sockets and attachments securely, ensuring safe working. A changeover into any predefined position is completed by simply pressing the release button – this is even the case in the 90° position.

The Zyklop Speed Ratchets, 1/4"

Combining 5 types of ratchet in 1 tool

8100 SA 6 Zyklop Speed Ratchet Set, 1/4" drive, metric

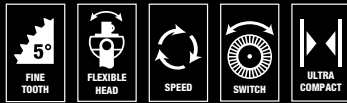

28-piece set; in a surface-preserving, compact and extremely robust textile box; low volume and weight for simplified mobility
 1 Zyklop Speed Ratchet with 1/4" drive, 9 Zyklop sockets, 1 Zyklop extension (long) with free-turning sleeve, 1 wobble extension, 1 adaptor with quick-release chuck, 15 bits

Code			
05004016001	○ 8000 A	1 x 1/4"x152.0	1
	● 8790 HMA	1 x 5.0x23.0; 1 x 5.5x23.0; 1 x 6.0x23.0; 1 x 7.0x23.0; 1 x 8.0x23.0; 1 x 10.0x23.0; 1 x 11.0x23.0; 1 x 12.0x23.0; 1 x 13.0x23.0	
	⊗ 8794 LA	1 x 1/4"x150.0	
	⊗ 8794 A	1 x 1/4"x56.0	
	⊗ 8784 A1	1 x 1/4"x1/4"x37.0	
	⊕ 851/4 TZ PH	1 x PH 1x50; 1 x PH 2x50; 1 x PH 3x50	
	⊕ 855/4 TZ PZ	1 x PZ 1x50; 1 x PZ 2x50	
	⊕ 867/4 Z TORX®	1 x TX 10x50; 1 x TX 15x50; 1 x TX 20x50; 1 x TX 25x50; 1 x TX 27x50; 1 x TX 30x50	
	○ 840/4 Z Hex-Plus	1 x 3.0x50; 1 x 4.0x50; 1 x 5.0x50; 1 x 6.0x50	

8100 SA 9 Zyklop Speed Ratchet Set, 1/4" drive, imperial

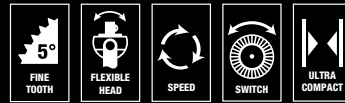

28-piece set; in a surface-preserving, compact and extremely robust textile box; low volume and weight for simplified mobility
 1 Zyklop Speed Ratchet with 1/4" drive, 9 Zyklop sockets, 1 Zyklop extension (long) with free-turning sleeve, 1 wobble extension, 1 adaptor with quick-release chuck, 15 bits

Code			
05004019001	○ 8000 A	1 x 1/4"x152.0	1
	● 8790 HMA	1 x 3/16"x23.0; 1 x 7/32"x23.0; 1 x 1/4"x23.0; 1 x 9/32"x23.0; 1 x 5/16"x23.0; 1 x 11/32"x23.0; 1 x 3/8"x23.0; 1 x 7/16"x23.0; 1 x 1/2"x23.0	
	⊗ 8794 LA	1 x 1/4"x150.0	
	⊗ 8794 A	1 x 1/4"x56.0	
	⊗ 8784 A1	1 x 1/4"x1/4"x37.0	
	⊕ 851/4 TZ PH	1 x PH 1x50; 1 x PH 2x50; 1 x PH 3x50	
	⊕ 855/4 TZ PZ	1 x PZ 1x50; 1 x PZ 2x50	
	⊕ 867/4 Z TORX®	1 x TX 10x50; 1 x TX 15x50; 1 x TX 20x50; 1 x TX 25x50; 1 x TX 27x50; 1 x TX 30x50	
	○ 840/4 Z Hex-Plus	1 x 5/32"x50; 1 x 3/16"x50; 1 x 7/32"x50; 1 x 1/4"x50	



Thumbwheel

All Zyklop Speed ratchets feature a thumbwheel that can be used to quickly and easily switch between clockwise and anticlockwise rotation, at any position. No complicated handling, no loss of time!



Screwdriver

The ratchet can be used as a conventional screwdriver in the 0° position by attaching a unique bitholding adaptor and a bit.



For more information on the Zyklop Speed ratchets please scan QR Code.



Textile boxes

Completely new textile boxes offer dramatically improved portability, and are space-saving to boot! This means you can now carry the same collection of tools, in a much more compact and comfortable package. The textile box including the tool will even survive a fall undamaged. And: it leaves absolutely no signs of scratches on sensitive surfaces.

The Zyklop Metal Ratchets Push, 1/4"

With push-through square

8003 A Zyklop Metal Ratchet with push-through square and 1/4" drive

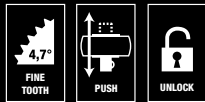

Application: 1/4" square sockets as well as for 1/4" adaptors with square drive, with ball locking device

Design: Forged, full metal ratchet (chrome-molybdenum) that is extremely robust with a long service life; slim design to enable work in very confined spaces; the dual-ratchet-teeth design means that a 76 fine-toothing division can be achieved from the 38 robust teeth with a return angle of only 4.7°; simple direction change with the undetachable push-through square and very secure socket lock mechanism

Code	mm	mm	mm		
05004003001	1/4"	141	21	22	3

8100 SA 10 Zyklop Metal Ratchet Set with push-through square, 1/4" drive, imperial



28-piece set; in a surface-preserving, compact and extremely robust textile box; low volume and weight for simplified mobility
1 Zyklop Metal Ratchet with push-through square and 1/4" drive, 9 Zyklop sockets, 1 Zyklop extension (long) with free-turning sleeve, 1 wobble extension, 1 adaptor with quick-release chuck, 15 bits

Code			
05004020001	8003 A	1 x 1/4"x141	1
	8790 HMA	1 x 3/16"x23.0; 1 x 7/32"x23.0; 1 x 1/4"x23.0; 1 x 9/32"x23.0; 1 x 5/16"x23.0; 1 x 11/32"x23.0; 1 x 3/8"x23.0; 1 x 7/16"x23.0; 1 x 1/2"x23.0	
	8794 LA	1 x 1/4"x150.0	
	8794 A	1 x 1/4"x56.0	
	8784 A1	1 x 1/4"x1/4"x37.0	
	851/1 Z PH	1 x PH 1x25; 1 x PH 2x25; 1 x PH 3x25	
	855/1 Z PZ	1 x PZ 1x25; 1 x PZ 2x25	
	867/1 Z TORX®	1 x TX 10x25; 1 x TX 15x25; 1 x TX 20x25; 1 x TX 25x25; 1 x TX 27x25; 1 x TX 30x25	
	840/1 Z Hex-Plus	1 x 5/32"x25; 1 x 3/16"x25; 1 x 7/32"x25; 1 x 1/4"x25	

8100 SA 7 Zyklop Metal Ratchet Set with push-through square, 1/4" drive, metric

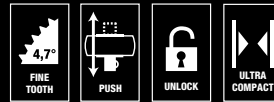

28-piece set; in a surface-preserving, compact and extremely robust textile box; low volume and weight for simplified mobility
1 Zyklop Metal Ratchet with push-through square and 1/4" drive, 9 Zyklop sockets, 1 Zyklop extension (long) with free-turning sleeve, 1 wobble extension, 1 adaptor with quick-release chuck, 15 bits

Code			
05004017001	8003 A	1 x 1/4"x141	1
	8790 HMA	1 x 5.0x23.0; 1 x 5.5x23.0; 1 x 6.0x23.0; 1 x 7.0x23.0; 1 x 8.0x23.0; 1 x 10.0x23.0; 1 x 11.0x23.0; 1 x 12.0x23.0; 1 x 13.0x23.0	
	8794 LA	1 x 1/4"x150.0	
	8794 A	1 x 1/4"x56.0	
	8784 A1	1 x 1/4"x1/4"x37.0	
	851/1 Z PH	1 x PH 1x25; 1 x PH 2x25; 1 x PH 3x25	
	855/1 Z PZ	1 x PZ 1x25; 1 x PZ 2x25	
	867/1 Z TORX®	1 x TX 10x25; 1 x TX 15x25; 1 x TX 20x25; 1 x TX 25x25; 1 x TX 27x25; 1 x TX 30x25	
	840/1 Z Hex-Plus	1 x 3.0x25; 1 x 4.0x25; 1 x 5.0x25; 1 x 6.0x25	

 **Wera Zyklop Ratchets**
Available by Wera only



Extremely slim

Extremely slim. Higher leverage. Incredibly tough, with incredible torque transfer. These ratchets are forged from chrome-moly steel, to be light and strong.



Push-through square

The push-through square that cannot get lost and the secure socket lock mechanism prevent unintentional switchover of direction.

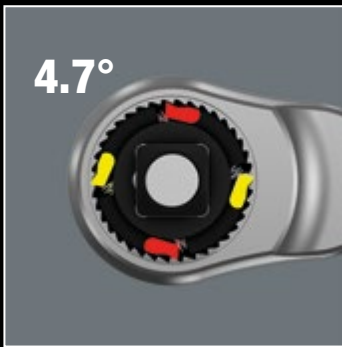

Small return angle

The unique twin-tooth design means that you have the strength of 38 teeth, and the fine action of 76, giving a low return angle of only 4.7 degrees.



The Zyklop Metal Ratchets Switch, 1/4"

With switch lever

8004 A Zyklop Metal Ratchet with switch lever and 1/4" drive



Application: 1/4" square sockets as well as for 1/4" adaptors with square drive, with ball locking device

Design: Forged, full metal ratchet (chrome-molybdenum) that is extremely robust with a long service life; slim design to enable work in very confined spaces; fine-tooth mechanism with 72 teeth for a return angle of only 5°; switch lever for convenient change of direction; secure socket locking function

Code	mm	mm	mm		
05004004001	1/4"	141	19	22	3

8100 SA 11 Zyklop Metal Ratchet Set with switch lever, 1/4" drive, imperial



28-piece set; in a surface-preserving, compact and extremely robust textile box; low volume and weight for simplified mobility
1 Zyklop Metal Ratchet with switch lever and 1/4" drive, 9 Zyklop sockets, 1 Zyklop extension (long) with free-turning sleeve, 1 wobble extension, 1 adaptor with quick-release chuck, 15 bits

8100 SA 8 Zyklop Metal Ratchet Set with switch lever, 1/4" drive, metric



28-piece set; in a surface-preserving, compact and extremely robust textile box; low volume and weight for simplified mobility
1 Zyklop Metal Ratchet with switch lever and 1/4" drive, 9 Zyklop sockets, 1 Zyklop extension (long) with free-turning sleeve, 1 wobble extension, 1 adaptor with quick-release chuck, 15 bits

Code			
05004021001	8004 A	1 x 1/4"x141	1
	8790 HMA	1 x 3/16"x23.0; 1 x 7/32"x23.0; 1 x 1/4"x23.0; 1 x 9/32"x23.0; 1 x 5/16"x23.0; 1 x 11/32"x23.0; 1 x 3/8"x23.0; 1 x 7/16"x23.0; 1 x 1/2"x23.0	
	8794 LA	1 x 1/4"x150.0	
	8794 A	1 x 1/4"x56.0	
	8784 A1	1 x 1/4"x1/4"x37.0	
	851/1 Z PH	1 x PH 1x25; 1 x PH 2x25; 1 x PH 3x25	
	855/1 Z PZ	1 x PZ 1x25; 1 x PZ 2x25	
	867/1 Z TORX®	1 x TX 10x25; 1 x TX 15x25; 1 x TX 20x25; 1 x TX 25x25; 1 x TX 27x25; 1 x TX 30x25	
	840/1 Z Hex-Plus	1 x 5/32"x25; 1 x 3/16"x25; 1 x 7/32"x25; 1 x 1/4"x25	

Code			
05004018001	8004 A	1 x 1/4"x141	1
	8790 HMA	1 x 5.0x23.0; 1 x 5.5x23.0; 1 x 6.0x23.0; 1 x 7.0x23.0; 1 x 8.0x23.0; 1 x 10.0x23.0; 1 x 11.0x23.0; 1 x 12.0x23.0; 1 x 13.0x23.0	
	8794 LA	1 x 1/4"x150.0	
	8794 A	1 x 1/4"x56.0	
	8784 A1	1 x 1/4"x1/4"x37.0	
	851/1 Z PH	1 x PH 1x25; 1 x PH 2x25; 1 x PH 3x25	
	855/1 Z PZ	1 x PZ 1x25; 1 x PZ 2x25	
	867/1 Z TORX®	1 x TX 10x25; 1 x TX 15x25; 1 x TX 20x25; 1 x TX 25x25; 1 x TX 27x25; 1 x TX 30x25	
	840/1 Z Hex-Plus	1 x 3.0x25; 1 x 4.0x25; 1 x 5.0x25; 1 x 6.0x25	

Wera Zyklop Ratchets
Available by Wera only



Extremely slim

Extremely slim. Higher leverage. Incredibly tough, with incredible torque transfer. These ratchets are forged from chrome-moly steel, to be light and strong.



Switch lever

Switch lever for convenient change of direction; secure socket locking function.



Small return angle

Fine tooth mechanism with 72 teeth for a return angle of only 5°.





The Zyklop Speed Ratchets, 3/8"

Combining 5 types of ratchet in 1 tool

8000 B Zyklop ratchet with 3/8" drive



Application: 3/8" square drive sockets and 3/8" adaptors with square drive, equipped with ball lock

Design: Flywheel design and easy-to-grip free-turning sleeve for faster work, swivel ratchet head, defined lock positions at 0° and 90° to the left and right as well as at 15° before 90° inwards, at 0° it can be used like a conventional screwdriver, pushbutton release, left/right switchover, fine-tooth design, small return angle of 5°

Handle: Multi-component Kraftform handle ensures minimum fatigue

Code	Icon	mm							
05003550001	3/8"	199.0							1

8100 SB 2 Zyklop Speed ratchet set, 3/8" drive, metric



43-piece set in strong metal case

1 Zyklop ratchet with 3/8" drive, 18 Zyklop sockets (metric), 2 Zyklop „flexible-lock“ extensions (short and long) with free-turning sleeve, 1 sliding T-handle, 1 wobble extension, 1 universal joint, 1 adaptor with quick-release chuck, 18 bits



Code	Icon	Item	Quantity	
05003594001	○	8000 B	1 x 3/8"x199.0	1
	●	8790 HMB	1 x 6.0x29.0; 1 x 7.0x29.0; 1 x 8.0x29.0; 1 x 9.0x29.0; 1 x 10.0x29.0; 1 x 11.0x29.0; 1 x 12.0x29.0; 1 x 13.0x29.0; 1 x 14.0x29.0; 1 x 15.0x29.0; 1 x 16.0x30.0; 1 x 17.0x30.0; 1 x 18.0x30.0; 1 x 19.0x30.0; 1 x 20.0x30.0; 1 x 21.0x30.0; 1 x 22.0x30.0; 1 x 24.0x32.0	
	○	8789 B	1 x 3/8"x165.0	
	○	8794 B	1 x 3/8"x76.0	
	○	8795 B	1 x 3/8"x50.0	
	○	8784 B1	1 x 1/4"x3/8"x44.0	
	○	8796 SB	1 x 3/8"x125.0	
	○	8796 LB	1 x 3/8"x200.0	
	○	840/1 Z Hex-Plus	1 x 3.0x25; 1 x 4.0x25; 1 x 5.0x25; 1 x 6.0x25; 1 x 8.0x25; 1 x 10.0x25	
	⊕	867/1 Z TORX® B0	1 x TX 10x25; 1 x TX 15x25; 1 x TX 20x25; 1 x TX 25x25; 1 x TX 27x25; 1 x TX 30x25; 1 x TX 40x25	
	⊖	800/1 Z	1 x 1.0x5.5x25	
	⊕	851/1 Z PH	1 x PH 2x25; 1 x PH 3x25	
	⊕	855/1 Z PZ	1 x PZ 2x25; 1 x PZ 3x25	

Wera Zyklop Ratchets
Available by Wera only

8100 SB 4 Zyklop Speed ratchet set, 3/8" drive, imperial



38-piece set in strong metal case

1 Zyklop ratchet with $\frac{3}{8}$ " drive, 12 Zyklop sockets (imperial), 2 Zyklop „flexible-lock“ extensions (short and long) with free-turning sleeve, 1 sliding T-handle, 1 wobble extension, 1 universal joint, 1 adaptor with quick-release chuck, 19 bits

Code			
05003596001	⊖	8000 B	1 x 3/8"x199.0
	⊙	8790 HMB	1 x 1/4"x29.0; 1 x 5/16"x29.0; 1 x 11/32"x29.0; 1 x 3/8"x29.0; 1 x 7/16"x29.0; 1 x 1/2"x29.0; 1 x 9/16"x29.0; 1 x 5/8"x30.0; 1 x 11/16"x30.0; 1 x 3/4"x30.0; 1 x 13/16"x30.0; 1 x 7/8"x30.0
	⊖	8789 B	1 x 3/8"x165.0
	⊖	8794 B	1 x 3/8"x76.0
	⊖	8795 B	1 x 3/8"x50.0
	⊖	8784 B1	1 x 1/4"x3/8"x44.0
	⊖	8796 SB	1 x 3/8"x125.0
	⊖	8796 LB	1 x 3/8"x200.0
	⊕	867/1 Z TORX® B0	1 x TX 10x25; 1 x TX 15x25; 1 x TX 20x25; 1 x TX 25x25; 1 x TX 27x25; 1 x TX 30x25; 1 x TX 40x25
	⊖	800/1 Z	1 x 1.0x5.5x25
	⊕	851/1 Z PH	1 x PH 2x25; 1 x PH 3x25
	⊕	855/1 Z PZ	1 x PZ 2x25; 1 x PZ 3x25
	⊖	840/1 Z Hex-Plus	1 x 5/64"x25; 1 x 3/32"x25; 1 x 1/8"x25; 1 x 9/64"x25; 1 x 5/32"x25; 1 x 3/16"x25; 1 x 7/32"x25

8100 SB 6 Zyklop Speed Ratchet Set, 3/8" drive, metric



29-piece set; in a surface-preserving, compact and extremely robust textile box; low volume and weight for simplified mobility

1 Zyklop Speed Ratchet with $\frac{3}{8}$ " drive, 9 Zyklop sockets, 1 Zyklop extension (long) with free-turning sleeve, 1 wobble extension, 1 adaptor with quick-release chuck, 16 bits

Code			
05004046001	⊖	8000 B	1 x 3/8"x199.0
	⊙	8790 HMB	1 x 8.0x29.0; 1 x 10.0x29.0; 1 x 12.0x29.0; 1 x 13.0x29.0; 1 x 15.0x29.0; 1 x 16.0x30.0; 1 x 17.0x30.0; 1 x 18.0x30.0; 1 x 19.0x30.0
	⊖	8794 LB	1 x 3/8"x200.0
	⊖	8794 B	1 x 3/8"x76.0
	⊖	8784 B1	1 x 1/4"x3/8"x44.0
	⊕	851/4 TZ PH	1 x PH 1x50; 1 x PH 2x50; 1 x PH 3x50
	⊕	855/4 TZ PZ	1 x PZ 1x50; 1 x PZ 2x50; 1 x PZ 3x50
	⊕	867/4 Z TORX®	1 x TX 20x50; 1 x TX 25x50; 1 x TX 27x50; 1 x TX 30x50; 1 x TX 40x50
	⊖	840/4 Z Hex-Plus	1 x 4.0x50; 1 x 5.0x50; 1 x 6.0x50; 1 x 8.0x50
	⊖	800/4 Z	1 x 1.0x5.5x50



For more information on the Zyklop Speed ratchets please scan QR Code.

The Zyklop Speed Ratchets, 3/8"

Combining 5 types of ratchet in 1 tool

8100 SB 9 Zyklop Speed Ratchet Set, 3/8" drive, imperial



29-piece set; in a surface-preserving, compact and extremely robust textile box; low volume and weight for simplified mobility

1 Zyklop Speed Ratchet with 3/8" drive, 9 Zyklop sockets, 1 Zyklop extension (long) with free-turning sleeve, 1 wobble extension, 1 adaptor with quick-release chuck, 16 bits

Code			
05004049001	⊖	8000 B	1 x 3/8"x199.0
	⊙	8790 HMB	1 x 1/4"x29.0; 1 x 5/16"x29.0; 1 x 3/8"x29.0; 1 x 7/16"x29.0; 1 x 1/2"x29.0; 1 x 9/16"x29.0; 1 x 5/8"x30.0; 1 x 11/16"x30.0; 1 x 3/4"x30.0
	⊙	8794 LB	1 x 3/8"x200.0
	⊙	8794 B	1 x 3/8"x76.0
	⊙	8784 B1	1 x 1/4"x3/8"x44.0
	+	851/4 TZ PH	1 x PH 1x50; 1 x PH 2x50; 1 x PH 3x50
	+	855/4 TZ PZ	1 x PZ 1x50; 1 x PZ 2x50; 1 x PZ 3x50
	⊕	867/4 Z TORX®	1 x TX 20x50; 1 x TX 25x50; 1 x TX 27x50; 1 x TX 30x50; 1 x TX 40x50
	⊖	840/4 Z Hex-Plus	1 x 3/16"x50; 1 x 7/32"x50; 1 x 1/4"x50; 1 x 5/16"x50
	⊖	800/4 Z	1 x 1.0x5.5x50



Textile boxes

Completely new textile boxes offer dramatically improved portability, and are space-saving to boot! This means you can now carry the same collection of tools, in a much more compact and comfortable package. The textile box including the tool will even survive a fall undamaged. And: it leaves absolutely no signs of scratches on sensitive surfaces.



For more information on the Zyklop Metal ratchets please scan QR Code.

The Zyklop Metal Ratchets Push, 3/8"

With push-through square

8003 B Zyklop Metal Ratchet with push-through square and 3/8" drive



Application: 3/8" square sockets as well as for 3/8" adaptors with square drive, with ball locking device

Design: Forged, full metal ratchet (chrome-molybdenum) that is extremely robust with a long service life; slim design to enable work in very confined spaces; the dual-ratchet-teeth design means that a 76 fine-toothing division can be achieved from the 38 robust teeth with a return angle of only 4.7°; simple direction change with the detachable push-through square and very secure socket lock mechanism

Code	mm	mm	mm		
05004033001	3/8"	222.0	27	29	3

8100 SB 7 Zyklop Metal Ratchet Set with push-through square, 3/8" drive, metric



29-piece set; in a surface-preserving, compact and extremely robust textile box; low volume and weight for simplified mobility

1 Zyklop Metal Ratchet with 3/8" drive, 9 Zyklop sockets, 1 Zyklop extension (long) with free-turning sleeve, 1 wobble extension, 1 adaptor with quick-release chuck, 16 bits

Code			
05004047001	8003 B	1 x 3/8"x222.0	1
	8790 HMB	1 x 8.0x29.0; 1 x 10.0x29.0; 1 x 12.0x29.0; 1 x 13.0x29.0; 1 x 15.0x29.0; 1 x 16.0x30.0; 1 x 17.0x30.0; 1 x 18.0x30.0; 1 x 19.0x30.0	
	8794 LB	1 x 3/8"x200.0	
	8794 B	1 x 3/8"x76.0	
	8784 B1	1 x 1/4"x3/8"x44.0	
	851/1 Z PH	1 x PH 1x25; 1 x PH 2x25; 1 x PH 3x25	
	855/1 Z PZ	1 x PZ 1x25; 1 x PZ 2x25	
	867/1 Z TORX®	1 x TX 15x25; 1 x TX 20x25; 1 x TX 25x25; 1 x TX 27x25; 1 x TX 30x25; 1 x TX 40x25	
	840/1 Z Hex-Plus	1 x 3.0x25; 1 x 4.0x25; 1 x 5.0x25; 1 x 6.0x25; 1 x 8.0x25	

8100 SB 10 Zyklop Metal Ratchet Set with push-through square, 3/8" drive, imperial

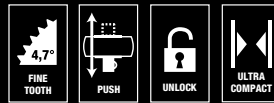

29-piece set; in a surface-preserving, compact and extremely robust textile box; low volume and weight for simplified mobility

1 Zyklop Metal Ratchet with 3/8" drive, 9 Zyklop sockets, 1 Zyklop extension (long) with free-turning sleeve, 1 wobble extension, 1 adaptor with quick-release chuck, 16 bits

Code			
05004050001	8003 B	1 x 3/8"x222.0	1
	8790 HMB	1 x 1/4"x29.0; 1 x 5/16"x29.0; 1 x 3/8"x29.0; 1 x 7/16"x29.0; 1 x 1/2"x29.0; 1 x 9/16"x29.0; 1 x 5/8"x30.0; 1 x 11/16"x30.0; 1 x 3/4"x30.0	
	8794 LB	1 x 3/8"x200.0	
	8794 B	1 x 3/8"x76.0	
	8784 B1	1 x 1/4"x3/8"x44.0	
	851/1 Z PH	1 x PH 1x25; 1 x PH 2x25; 1 x PH 3x25	
	855/1 Z PZ	1 x PZ 1x25; 1 x PZ 2x25	
	867/1 Z TORX®	1 x TX 15x25; 1 x TX 20x25; 1 x TX 25x25; 1 x TX 27x25; 1 x TX 30x25; 1 x TX 40x25	
	840/1 Z Hex-Plus	1 x 5/32"x25; 1 x 3/16"x25; 1 x 7/32"x25; 1 x 1/4"x25; 1 x 5/16"x25	



The Zyklop Metal Ratchets Switch, 3/8"

With switch lever

8004 B Zyklop Metal Ratchet with switch lever and 3/8" drive



Application: 3/8" square sockets as well as for 3/8" adaptors with square drive, with ball locking device

Design: Forged, full metal ratchet (chrome-molybdenum) that is extremely robust with a long service life; slim design to enable work in very confined spaces; fine-tooth mechanism with 72 teeth for a return angle of only 5°; switch lever for convenient change of direction; secure socket locking function

Code	mm	mm	mm	
05004034001	3/8"	222,0	26	29

8100 SB 11 Zyklop Metal Ratchet Set with switch lever, 3/8" drive, imperial



29-piece set; in a surface-preserving, compact and extremely robust textile box; low volume and weight for simplified mobility
1 Zyklop Metal Ratchet with 3/8" drive, 9 Zyklop sockets, 1 Zyklop extension (long) with free-turning sleeve, 1 wobble extension, 1 adaptor with quick-release chuck, 16 bits

8100 SB 8 Zyklop Metal Ratchet Set with switch lever, 3/8" drive, metric



29-piece set; in a surface-preserving, compact and extremely robust textile box; low volume and weight for simplified mobility
1 Zyklop Metal Ratchet with 3/8" drive, 9 Zyklop sockets, 1 Zyklop extension (long) with free-turning sleeve, 1 wobble extension, 1 adaptor with quick-release chuck, 16 bits

Code			
05004051001	8004 B	1 x 3/8"x222,0	1
	8790 HMB	1 x 1/4"x29.0; 1 x 5/16"x29.0; 1 x 3/8"x29.0; 1 x 7/16"x29.0; 1 x 1/2"x29.0; 1 x 9/16"x29.0; 1 x 5/8"x30.0; 1 x 11/16"x30.0; 1 x 3/4"x30.0	
	8794 LB	1 x 3/8"x200.0	
	8794 B	1 x 3/8"x76.0	
	8784 B1	1 x 1/4"x3/8"x44.0	
	851/1 Z PH	1 x PH 1x25; 1 x PH 2x25; 1 x PH 3x25	
	855/1 Z PZ	1 x PZ 1x25; 1 x PZ 2x25	
	867/1 Z TORX®	1 x TX 15x25; 1 x TX 20x25; 1 x TX 25x25; 1 x TX 27x25; 1 x TX 30x25; 1 x TX 40x25	
	840/1 Z Hex-Plus	1 x 5/32"x25; 1 x 3/16"x25; 1 x 7/32"x25; 1 x 1/4"x25; 1 x 5/16"x25	

Code			
05004048001	8004 B	1 x 3/8"x222,0	1
	8790 HMB	1 x 8.0x29.0; 1 x 10.0x29.0; 1 x 12.0x29.0; 1 x 13.0x29.0; 1 x 15.0x29.0; 1 x 16.0x30.0; 1 x 17.0x30.0; 1 x 18.0x30.0; 1 x 19.0x30.0	
	8794 LB	1 x 3/8"x200.0	
	8794 B	1 x 3/8"x76.0	
	8784 B1	1 x 1/4"x3/8"x44.0	
	851/1 Z PH	1 x PH 1x25; 1 x PH 2x25; 1 x PH 3x25	
	855/1 Z PZ	1 x PZ 1x25; 1 x PZ 2x25	
	867/1 Z TORX®	1 x TX 15x25; 1 x TX 20x25; 1 x TX 25x25; 1 x TX 27x25; 1 x TX 30x25; 1 x TX 40x25	
	840/1 Z Hex-Plus	1 x 3.0x25; 1 x 4.0x25; 1 x 5.0x25; 1 x 6.0x25; 1 x 8.0x25	

or more information on the Zyklop Metal ratchets please scan QR Code.



The Zyklop Speed Ratchets, 1/2"

Combining 5 types of ratchet in 1 tool

8000 C Zyklop Speed ratchet with 1/2" drive

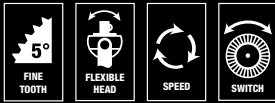

Application: 1/2" square drive sockets and 1/2" adapters with square drive, equipped with ball lock

Design: Flywheel design and easy-to-grip free-turning sleeve for faster work, swivel ratchet head, defined lock positions at 0° and 90° to the left and right as well as at 15° before 90° inwards, at 0° it can be used like a conventional screwdriver, pushbutton release, left/right switchover, fine-tooth design, small return angle of 5°

Handle: Multi-component Kraffform handle ensures minimum fatigue

Code	Icon	mm							
05003600001	1/2"	277.0							1

8100 SC 2 Zyklop Speed ratchet set, 1/2" drive, metric

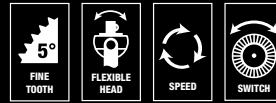

37-piece set in strong metal case

1 Zyklop ratchet with 1/2" drive, 17 Zyklop sockets (metric), 2 Zyklop „flexible-lock“ extensions (short and long) with free-tuning sleeve, 1 sliding T-handle, 1 universal joint, 1 wobble extension, 1 adaptor with quick-release chuck, 13 bits



Code	Icon	Item	Quantity	
05003645001	○	8000 C	1 x 1/2"x277.0	1
	●	8790 HMC	1 x 10.0x37.0; 1 x 11.0x37.0; 1 x 12.0x37.0; 1 x 13.0x37.0; 1 x 14.0x37.0; 1 x 15.0x37.0; 1 x 16.0x37.0; 1 x 17.0x37.0; 1 x 18.0x37.0; 1 x 19.0x37.0; 1 x 20.0x37.0; 1 x 21.0x37.0; 1 x 22.0x37.0; 1 x 24.0x37.0; 1 x 27.0x40.0; 1 x 30.0x42.0; 1 x 32.0x42.0	
	○	8789 C	1 x 1/2"x250.0	
	●	8794 C	1 x 1/2"x52.0	
	●	8795 C	1 x 1/2"x69.0	
	●	8784 C2	1 x 5/16"x1/2"x50.0	
	●	8796 SC	1 x 1/2"x125.0	
	●	8796 LC	1 x 1/2"x250.0	
	○	840/2 Z	1 x 5x30; 1 x 6x30; 1 x 8x30; 1 x 10x30	
	+	851/2 Z PH	1 x PH 3x32	
	+	855/2 Z PZ	1 x PZ 3x32	
	⊕	867/2 Z TORX®	1 x TX 20x35; 1 x TX 25x35; 1 x TX 30x35; 1 x TX 40x35; 1 x TX 45x35; 1 x TX 50x35; 1 x TX 55x35	

8100 SC 4 Zyklop Speed ratchet set, 1/2" drive, imperial

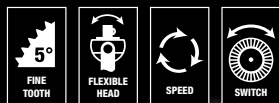

38-piece set in strong metal case

1 Zyklop ratchet with 1/2" drive, 18 Zyklop sockets (imperial), 2 Zyklop „flexible-lock“ extensions (short and long) with free-tuning sleeve, 1 sliding T-handle, 1 universal joint, 1 wobble extension, 1 adaptor with quick-release chuck, 13 bits

Code			
05003647001	8000 C	1 x 1/2"x277.0	1
	8790 HMC	1 x 3/8"x37.0; 1 x 7/16"x37.0; 1 x 1/2"x37.0; 1 x 9/16"x37.0; 1 x 19/32"x37.0; 1 x 5/8"x37.0; 1 x 11/16"x37.0; 1 x 3/4"x37.0; 1 x 25/32"x37.0; 1 x 13/16"x37.0; 1 x 7/8"x37.0; 1 x 15/16"x37.0; 1 x 31/32"x37.0; 1 x 1"x40.0; 1 x 1 1/16"x40.0; 1 x 1 1/8"x40.0; 1 x 1 3/16"x42.0; 1 x 1 1/4"x42.0	
	8789 C	1 x 1/2"x250.0	
	8794 C	1 x 1/2"x52.0	
	8795 C	1 x 1/2"x69.0	
	8784 C2	1 x 5/16"x1/2"x50.0	
	8796 SC	1 x 1/2"x125.0	
	8796 LC	1 x 1/2"x250.0	
	851/2 Z PH	1 x PH 3x32	
	855/2 Z PZ	1 x PZ 3x32	
	867/2 Z TORX®	1 x TX 20x35; 1 x TX 25x35; 1 x TX 30x35; 1 x TX 40x35; 1 x TX 45x35; 1 x TX 50x35; 1 x TX 55x35	
	840/2 Z	1 x 7/32"x30; 1 x 1/4"x30; 1 x 5/16"x30; 1 x 3/8"x30	

8100 SC 6 Zyklop Speed Ratchet Set, 1/2" drive, metric



28-piece set; in a surface-preserving, compact and extremely robust textile box; low volume and weight for simplified mobility

1 Zyklop Speed Ratchet with 1/2" drive, 10 Zyklop sockets, 1 Zyklop extension (long) with free-turning sleeve, 1 wobble extension, 1 adaptor with quick-release chuck, 14 bits

Code			
05004076001	8000 C	1 x 1/2"x277.0	1
	8790 HMC	1 x 10.0x37.0; 1 x 11.0x37.0; 1 x 12.0x37.0; 1 x 13.0x37.0; 1 x 14.0x37.0; 1 x 15.0x37.0; 1 x 16.0x37.0; 1 x 17.0x37.0; 1 x 18.0x37.0; 1 x 19.0x37.0	
	8794 LC	1 x 1/2"x250.0	
	8794 C	1 x 1/2"x52.0	
	8784 C2	1 x 5/16"x1/2"x50.0	
	851/2 Z PH	1 x PH 2x32; 1 x PH 3x32	
	855/2 Z PZ	1 x PZ 2x32; 1 x PZ 3x32	
	867/2 Z TORX®	1 x TX 20x35; 1 x TX 25x35; 1 x TX 30x35; 1 x TX 40x35; 1 x TX 45x35; 1 x TX 50x35	
	840/2 Z	1 x 5x30; 1 x 6x30; 1 x 8x30; 1 x 10x30	



For more information on the Zyklop Speed ratchets please scan QR Code.

The Zyklop Speed Ratchets, 1/2"

Combining 5 types of ratchet in 1 tool

8100 SC 9 Zyklop Speed Ratchet Set, 1/2" drive, imperial



28-piece set; in a surface-preserving, compact and extremely robust textile box; low volume and weight for simplified mobility

1 Zyklop Speed Ratchet with 1/2" drive, 10 Zyklop sockets, 1 Zyklop extension (long) with free-turning sleeve, 1 wobble extension, 1 adaptor with quick-release chuck, 14 bits

Code			
05004079001	○ 8000 C	1 x 1/2"x277.0	1
	● 8790 HMC	1 x 3/8"x37.0; 1 x 7/16"x37.0; 1 x 1/2"x37.0; 1 x 9/16"x37.0; 1 x 19/32"x37.0; 1 x 5/8"x37.0; 1 x 11/16"x37.0; 1 x 3/4"x37.0; 1 x 25/32"x37.0; 1 x 13/16"x37.0	
	● 8794 LC	1 x 1/2"x250.0	
	● 8794 C	1 x 1/2"x52.0	
	● 8784 C2	1 x 5/16"x1/2"x50.0	
	⊕ 851/2 Z PH	1 x PH 2x32; 1 x PH 3x32	
	⊕ 855/2 Z PZ	1 x PZ 2x32; 1 x PZ 3x32	
	⊕ 867/2 Z TORX®	1 x TX 20x35; 1 x TX 25x35; 1 x TX 30x35; 1 x TX 40x35; 1 x TX 45x35; 1 x TX 50x35	
	○ 840/2 Z	1 x 7/32"x30; 1 x 1/4"x30; 1 x 5/16"x30; 1 x 3/8"x30	



The Zyklop Metal Ratchets Push, 1/2"

With push-through square

8003 C Zyklop Metal Ratchet with push-through square and 1/2" drive

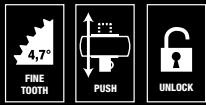

Application: 1/2" square sockets as well as for 1/2" adaptors with square drive, with ball locking device

Design: Forged, full metal ratchet (chrome-molybdenum) that is extremely robust with a long service life; slim design to enable work in very confined spaces; the dual-ratchet-teeth design means that a 76 fine-toothing division can be achieved from the 38 robust teeth with a return angle of only 4.7°; simple direction change with the undetachable push-through square and very secure socket lock mechanism

Code	mm	mm	mm		
05004063001	1/2"	281	36	37	3

8100 SC 10 Zyklop Metal Ratchet Set with push-through square, 1/2" drive, imperial



28-piece set; in a surface-preserving, compact and extremely robust textile box; low volume and weight for simplified mobility
 1 Zyklop Metal Ratchet with push-through square and 1/2" drive, 10 Zyklop sockets, 1 Zyklop extension (long) with free-turning sleeve, 1 wobble extension, 1 adaptor with quick-release chuck, 14 bits

8100 SC 7 Zyklop Metal Ratchet Set with push-through square, 1/2" drive, metric



28-piece set; in a surface-preserving, compact and extremely robust textile box; low volume and weight for simplified mobility
 1 Zyklop Metal Ratchet with push-through square and 1/2" drive, 10 Zyklop sockets, 1 Zyklop extension (long) with free-turning sleeve, 1 wobble extension, 1 adaptor with quick-release chuck, 14 bits

Code			
05004080001	8003 C	1 x 1/2"x281	1
	8790 HMC	1 x 3/8"x37.0; 1 x 7/16"x37.0; 1 x 1/2"x37.0; 1 x 9/16"x37.0; 1 x 19/32"x37.0; 1 x 5/8"x37.0; 1 x 11/16"x37.0; 1 x 3/4"x37.0; 1 x 25/32"x37.0; 1 x 13/16"x37.0	
	8794 LC	1 x 1/2"x250.0	
	8794 C	1 x 1/2"x52.0	
	8784 C2	1 x 5/16"x1/2"x50.0	
	851/2 Z PH	1 x PH 2x32; 1 x PH 3x32	
	867/2 Z TORX®	1 x TX 20x35; 1 x TX 25x35; 1 x TX 27x35; 1 x TX 30x35; 1 x TX 40x35; 1 x TX 45x35; 1 x TX 50x35; 1 x TX 55x35	
	840/2 Z	1 x 7/32"x30; 1 x 1/4"x30; 1 x 5/16"x30; 1 x 3/8"x30	

Code			
05004077001	8003 C	1 x 1/2"x281	1
	8790 HMC	1 x 10.0x37.0; 1 x 11.0x37.0; 1 x 12.0x37.0; 1 x 13.0x37.0; 1 x 14.0x37.0; 1 x 15.0x37.0; 1 x 16.0x37.0; 1 x 17.0x37.0; 1 x 18.0x37.0; 1 x 19.0x37.0	
	840/2 Z	1 x 5x30; 1 x 5x30; 1 x 6x30; 1 x 6x30; 1 x 8x30; 1 x 8x30; 1 x 10x30; 1 x 10x30	
	8794 LC	1 x 1/2"x250.0	
	8794 C	1 x 1/2"x52.0	
	8784 C2	1 x 5/16"x1/2"x50.0	
	851/2 Z PH	1 x PH 2x32; 1 x PH 3x32	
	867/2 Z TORX®	1 x TX 20x35; 1 x TX 25x35; 1 x TX 27x35; 1 x TX 30x35; 1 x TX 40x35; 1 x TX 45x35; 1 x TX 50x35; 1 x TX 55x35	

The Zyklop Metal Ratchets Switch, 1/2"

With switch lever

8004 C Zyklop Metal Ratchet with switch lever and 1/2" drive



Application: 1/2" square sockets as well as for 1/2" adaptors with square drive, with ball locking device

Design: Forged, full metal ratchet (chrome-molybdenum) that is extremely robust with a long service life; slim design to enable work in very confined spaces; the dual-ratchet-teeth design means that a 76 fine-toothing division can be achieved from the 38 robust teeth with a return angle of only 4.7°; simple direction change with the undetachable push-through square and very secure socket lock mechanism

Code	mm	mm	mm		
05004064001	1/2"	281	34	37	3

8100 SC 8 Zyklop Metal Ratchet Set with switch lever, 1/2" drive, metric



28-piece set, in a surface-preserving, compact and extremely robust textile box; low volume and weight for simplified mobility
1 Zyklop Metal Ratchet with switch lever and 1/2" drive, 10 Zyklop sockets, 1 Zyklop extension (long) with free-turning sleeve, 1 wobble extension, 1 adaptor with quick-release chuck, 14 bits

Code			
05004078001	8004 C	1 x 1/2"x281	1
	8790 HMC	1 x 10.0x37.0; 1 x 11.0x37.0; 1 x 12.0x37.0; 1 x 13.0x37.0; 1 x 14.0x37.0; 1 x 15.0x37.0; 1 x 16.0x37.0; 1 x 17.0x37.0; 1 x 18.0x37.0; 1 x 19.0x37.0	
	8794 LC	1 x 1/2"x250.0	
	8794 C	1 x 1/2"x52.0	
	8784 C2	1 x 5/16"x1/2"x50.0	
	851/2 Z PH	1 x PH 2x32; 1 x PH 3x32	
	867/2 Z TORX®	1 x TX 20x35; 1 x TX 25x35; 1 x TX 27x35; 1 x TX 30x35; 1 x TX 40x35; 1 x TX 45x35; 1 x TX 50x35; 1 x TX 55x35	
	840/2 Z	1 x 5x30; 1 x 6x30; 1 x 8x30; 1 x 10x30	

8100 SC 11 Zyklop Metal Ratchet Set with switch lever, 1/2" drive, imperial



28-piece set, in a surface-preserving, compact and extremely robust textile box; low volume and weight for simplified mobility
1 Zyklop Metal Ratchet with switch lever and 1/2" drive, 10 Zyklop sockets, 1 Zyklop extension (long) with free-turning sleeve, 1 wobble extension, 1 adaptor with quick-release chuck, 14 bits

Code			
05004081001	8004 C	1 x 1/2"x281	1
	8790 HMC	1 x 3/8"x37.0; 1 x 7/16"x37.0; 1 x 1/2"x37.0; 1 x 9/16"x37.0; 1 x 19/32"x37.0; 1 x 5/8"x37.0; 1 x 11/16"x37.0; 1 x 3/4"x37.0; 1 x 25/32"x37.0; 1 x 13/16"x37.0	
	8794 LC	1 x 1/2"x250.0	
	8794 C	1 x 1/2"x52.0	
	8784 C2	1 x 5/16"x1/2"x50.0	
	851/2 Z PH	1 x PH 2x32; 1 x PH 3x32	
	867/2 Z TORX®	1 x TX 20x35; 1 x TX 25x35; 1 x TX 27x35; 1 x TX 30x35; 1 x TX 40x35; 1 x TX 45x35; 1 x TX 50x35; 1 x TX 55x35	
	840/2 Z	1 x 7/32"x30; 1 x 1/4"x30; 1 x 5/16"x30; 1 x 3/8"x30	



KOLOSS

This ratchet is a hit... Really!

8002 C KOLOSS All Inclusive Set with 1/2" drive

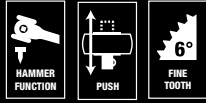

Application: Ratchet function for 1/2" square sockets and 1/2" adaptors with square drive, equipped with ball lock, hammer function e.g. to align work pieces

Design: Push-through square drive for forward and reverse operation, fine-tooth ratchet mechanism, small return angle of 6°, can transfer at least 600 Nm of torque, tubular shaft to minimise impact vibrations, drop-forged hammer head, positively pinned, ground striking face

Handle: Multi-component Kraftform handle for optimum pressure, impact and tensile loads, handle end designed for connection of KOLOSS extension 8780 C and KOLOSS centering pin 8781 C

Code				
05133862001	8002 C	1 x 1/2"x341.0		1
	8782 C	1 x 2x50.0		
	8780 C	1 x 341.0x137		
	8000 E	1 x Extension release pin		
	8000 HLF	1 x Holster		

8780 C KOLOSS extension



Application: Extension for use with Wera KOLOSS 8002 C to increase torque transfer

Design: Tough, tempered Cr-Mo steel

Handle: Multi-component Kraftform handle for optimum pressure, impact and tensile loads, laser-engraved safety instructions for permanent recognition

Code	mm	mm							
05003695001	341.0	137							1

8782 C KOLOSS pad set



Application: Protective attachment for striking faces for use with Wera Koloss 8002 C to protect materials and surfaces

Design: Flexible, thermoplastic elastomer material for lasting elasticity and maximum protection

Code	#	mm							
05003697001	2	50.0							5



Square drive

The KOLOSS from Wera – a ratchet that can also safely and officially be used as a hammer! The KOLOSS is a reversible, heavy-duty ratchet that can be used with a load of at least 600 Newton meters. Dual ratchet teeth and the minimal 6° return angle ensure rapid and precise screwdriving even in confined situations. And the best thing: absolutely no blow to the hammer faces, however hard, can destroy the ratchet mechanism.



Square drive

Permanently locked, hardened square drive, which gives way to impacts and cannot be damaged when the ratchet is used as a hammer. The push-through square drive, including the tooth system, is far more robust than a forward/reverse switch.



Double pawl mechanism

A double pawl mechanism and a return angle of only 6° allow you to tighten and loosen screws quickly and accurately even in cramped conditions.



Rubber pad

Dry-fined hammer face: used with rubber pad attachments to protect materials and surfaces.

Kraftform Torque Screwdrivers

For controlled tightening

Wera's adjustable torque screwdrivers allow variable torque settings with maximum precision and ensure that the user gets the very best results in the familiar Wera design with superior ergonomics.



Wera torque tools permit torque-controlled tightening to prevent damage to screws or work pieces and to ensure the dependability of the screw connection. This makes labour-intensive drilling-out of the screw and unproductive downtimes a thing of the past. Also important whenever repeat accuracy is needed.

Includes the ergonomic Kraftform handle that clicks audibly and noticeably when the desired torque is reached.

62 Instead of special blades, standard 1/4" hex bits, in any length, can be used, as well as 1/4" square drive sockets.

The Kraftform pistolgrip handle allows real power to be applied, directly to the fastener. It fits securely and comfortably in the hand, and provides the best possible leverage for higher torque requirements.



Simple setting of the required torque by hand.



Easy-to-read scale value.



Measurement accuracy is $\pm 6\%$ in accordance with the standard EN ISO 6789. Distinctly tactile and audible excess-load indication, when the desired torque is achieved.



Unlimited by hand-transferable torque for loosening seized screws.



Rapidaptor technology makes the tool adaptable since bits and sockets can be exchanged rapidly.

Series 7400 Kraftform Torque Screwdrivers

Variable torque adjustment models

Series 7400 Kraftform adjustable torque screwdrivers (0.1-3.0 Nm) with Rapidaptor quick-release chuck



Application: Suitable for 1/4" DIN 3126-C 6.3 and E 6.3 (ISO 1173) hexagon insert bits and Wera Series 1 and 4

Design: Rapidaptor rapid-in, rapid-out, rapid-spin, chuck-all and single-hand technology

Accuracy: ±6 % (EN ISO 6789). Numerical torque value scale, audible excess-load signal

Handle: Kraftform with non-roll feature, multi-component

Code	Art.No.	mm	Nm	Nm	mm	mm	
05074770001 ¹⁾	7430	89	1/4"	0,10-0,34	0,015	142	5 7/16" 1
05074772001 ¹⁾	7431	89	1/4"	0,30-1,00	0,05	142	5 7/16" 1
05074774001 ¹⁾	7432	89	1/4"	0,90-1,50	0,05	142	5 7/16" 1
05074700001	7440	105	1/4"	0,30-1,20	0,05	155	6" 1
05074701001	7441	105	1/4"	1,20-3,00	0,10	155	6" 1

¹⁾With attachable magnifying glass, dramatically improving visibility.

Series 7400 Kraftform adjustable torque screwdrivers (2.5-29.0 in. lbs.) with Rapidaptor quick-release chuck



Application: Suitable for 1/4" DIN 3126-C 6.3 and E 6.3 (ISO 1173) hexagon insert bits and Wera Series 1 and 4

Design: Rapidaptor rapid-in, rapid-out, rapid-spin, chuck-all and single-hand technology

Accuracy: ±6 % (EN ISO 6789). Numerical torque value scale. Audible excess-load signal

Handle: Kraftform with non-roll feature, multi-component

Code	Art.No.	in. lbs.	in. lbs.	mm	mm	
05074710001	7445	1/4"	2.5-11.5	0.5	155	6" 1
05074711001	7446	1/4"	11.0-29.0	1.0	155	6" 1



Simple setting

Wera's adjustable torque screwdrivers allow variable torque settings with maximum precision and ensure that the user gets the very best results in the familiar Wera design with superior ergonomics.

Measurement accuracy is ± 6 % in accordance with the standard EN ISO 6789. Easy-to-read scale value.

Unlimited torque for loosening seized screws.



Excess-load signal

Distinctly tactile and audible excess-load indication, when the desired torque is achieved.

Series 7400 Kraftform pistol grip, adjustable torque screwdrivers (3.0-8.8 Nm) with Rapidaptor quick-release chuck



Application: Suitable for 1/4" DIN 3126-C 6.3 and E 6.3 (ISO 1173) hexagon insert bits and Wera Series 1 and 4

Design: Rapidaptor rapid-in, rapid-out, rapid-spin, chuck-all and single-hand technology

Accuracy: ±6 % (EN ISO 6789). Numerical torque value scale. Audible excess-load signal

Handle: Kraftform pistol grip, multi-component

Code	Art.No.	1/4"	Nm	Nm	mm	mm	mm	mm
05074702001	7442	1/4"	3.0-6.0	0.25	150	100	4"	1
05074705001	7443	1/4"	4.0-8.8	0.40	150	100	4"	1

Series 7400 Kraftform pistol grip, adjustable torque screwdrivers (25,0-55,0 in. lbs.) with Rapidaptor quick-release chuck



Application: Suitable for 1/4" DIN 3126-C 6.3 and E 6.3 (ISO 1173) hexagon insert bits and Wera Series 1 and 4

Design: Rapidaptor rapid-in, rapid-out, rapid-spin, chuck-all and single-hand technology

Accuracy: ±6 % (EN ISO 6789). Numerical torque value scale. Audible excess-load signal

Handle: Kraftform pistol grip, multi-component

Code	Art.No.	1/4"	in. lbs.	in. lbs.	mm	mm	mm	mm
05074712001	7447	1/4"	25.0-55.0	2.5	150	100	4"	1



Rapidaptor

Rapidaptor technology makes the tool adaptable since 1/4" bits (and sockets) can be exchanged rapidly.



Attachable magnifying glass

Articles 7430, 7431 and 7432 all come with a magnifying glass. This can be easily attached on to the scale, dramatically improving visibility.

Kraftform Plus – Series 300

The right tool for every application

350 PH Screwdriver for Phillips screws



Application: Phillips screws

Blade: Round

Design: Chrome-plated, Lasertip

Handle: Kraftform with non-roll feature, multi-component

Code	+	mm	mm	mm	mm			
05008705001 ¹⁾	PH 0	60	81	3.0	2 3/8"			5
05008706001 ¹⁾	PH 0	100	81	3.0	4"			5
05008710001	PH 1	80	98	4.5	3 1/8"			10
05008712001	PH 1	200	98	4.5	8"			2
05008715001 ¹⁾	PH 1	300	98	4.5	12"			2
05008720001	PH 2	100	105	6.0	4"			10
05008723001	PH 2	150	105	6.0	6"			10
05008725001	PH 2	200	105	6.0	8"			2
05008730001 ¹⁾	PH 2	300	105	6.0	12"			2
05008735001	PH 3	150	112	8.0	6"			5
05008740001 ¹⁾	PH 4	200	112	10.0	8"			2

352 Ball end screwdriver for hexagon socket screws



Application: Hexagon socket screws

Blade: Hexagonal

Design: Ball end hexagon, chrome-plated, Black Point

Handle: Kraftform with non-roll feature, multi-component, sizes W/F 12.0, W/F 1/2": Kraftform with non-roll feature, single-component

Code	mm	mm	mm	mm	mm			
05022795001	1.5		60	70	2 3/8"			10
05022800001	2.0		100	70	4"			10
05138070001	2.5		100	81	4"			10
05022805001	3.0		100	81	4"			10
05022810001	4.0		100	98	4"			10
05022815001	5.0		100	105	4"			10
05022820001	6.0		125	105	5"			5
05022825001	8.0		150	112	6"			5
05022830001	10.0		150	112	6"			5
05022835001	12.0		150	117	6"			5
05022905001	5/32"		100	98	4"			5
05022910001	3/16"		100	105	4"			5
05022915001	7/32"		100	105	4"			5
05022920001	1/4"	125	105	5"				5
05022925001	5/16"	150	112	6"				5
05022930001	3/8"	150	112	6"				5
05022935001	1/2"	150	117	6"				5



Kraftform handle

The outstanding design of the Kraftform handle that fits perfectly into the hand prevents hand injuries such as blisters and calluses.



Lasertip

The sharp-edged surface structure of the Wera Lasertip "bites" itself into the screw head and prevents any slips out of the recess.





Kraftform Plus – Series 900

The chiseldriver for fastening and chiselling

932 A Screwdriver for slotted screws



Application: Slotted screws

Blade: Hexagonal throughout with impact cap and hexagonal bolster from size 0.8 x 4.5

Design: Chrome-plated, Black Point

Handle: Kraftform with non-roll feature, multi-component, sizes 2.0 x 12.0, 2.5 x 14.0: Kraftform with non-roll feature, single-component

Code	mm	mm	mm	mm	mm	mm	mm	mm	mm
05018260001	0.6	3.5	4		80	81	9/64"	3 1/8"	10
05018262001	0.8	4.5	5	8	90	98	0.178"	3 1/2"	10
05018264001	1.0	5.5	6	10	100	105	7/32"	4"	10
05018266001	1.2	7.0	6	10	125	105	9/32"	5"	10
05018268001	1.6	9.0	8	13	150	112	11/32"	6"	10
05018270001	1.6	10.0	8	13	175	112	3/8"	7"	5
05018272001	2.0	12.0	10	16	200	117	1/2"	8"	2
05018274001	2.5	14.0	10	16	250	117	9/16"	10"	2

917 SPH Screwdriver for Phillips screws



Application: Phillips screws

Blade: Hexagonal throughout with impact cap, hexagonal bolster for sizes 1 - 4

Design: Chrome-plated, Black Point

Handle: Kraftform with non-roll feature, multi-component, size 4/200: Kraftform with non-roll feature, single-component

Code	mm	mm	mm	mm	mm	mm	mm
05017005001	PH 1	5	8	80	98	3 1/8"	10
05017010001	PH 2	6	10	100	105	4"	10
05017015001	PH 3	8	13	150	112	6"	5
05017020001	PH 4	10	16	200	117	8"	2

977 Screwdriver for TORX® screws



Application: TORX® socket screws

Blade: Hexagonal throughout with impact cap, hexagonal bolster

Design: Chrome-plated, Black Point

Handle: Kraftform with non-roll feature, multi-component

Code	mm	mm	mm	mm	mm	mm	mm
05024400001	TX 15	5	8	80	98	3 1/8"	10
05024401001	TX 20	5	8	90	98	3 1/2"	10
05024402001	TX 25	6	10	100	105	4"	10
05024403001	TX 27	6	10	125	105	5"	10
05024404001	TX 30	8	13	150	112	6"	10
05024405001	TX 40	8	13	150	112	6"	10

The Chiseldriver
Available by Wera only



Pound-thru hexagon blade

The Chiseldriver is the solution whenever the job requires more than just screwdriving. It is suitable for fastening, chiselling and loosening seized screws or screw clamps. A hexagon blade made out of high-quality bit material extends right through the handle – thereby ensuring full transfer of force, even when struck with a hammer. The ductile tempered material prevents the blade from splintering or breaking.



Impact cap

An integrated impact cap lengthens the service life and reduces the danger of splintering. Nevertheless, always wear protective goggles.



Hex bolster

Greater torque can be transferred by fitting an open-jaw or ring spanner over the integrated hex bolster.



Non-roll feature

The hexagonal non-roll feature prevents any annoying rolling away at the workplace.

ESD Series

ESD-safe tools

1578 A Kraftform Micro screwdriver for slotted screws

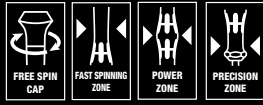

Application: Slotted screws

Blade: Round

Design: Chrome-plated, Black Point

Handle: Kraftform Micro with non-roll feature and rotating cap, multi-component

Code	mm	mm	mm	mm	mm	mm	mm	mm	mm
05030101001	0.23	1.5	40	97	2.5	1/16"	1 9/16"	5	
05030100001	0.25	1.2	40	97	2.5	0.05"	1 9/16"	5	
05030102001	0.30	1.8	60	97	2.5	0.07"	2 3/8"	5	
05030103001	0.40	2.0	60	97	2.5	5/64"	2 3/8"	5	
05030104001	0.40	2.5	80	97	2.5	3/32"	3 1/8"	5	
05030105001	0.50	3.0	80	97	3.0	1/8"	3 1/8"	5	
05030106001	0.60	3.5	80	97	4.0	9/64"	3 1/8"	5	
05030107001	0.80	4.0	80	97	4.0	5/32"	3 1/8"	5	

1550 PH Kraftform Micro screwdriver for Phillips screws

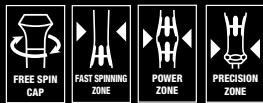

Application: Phillips screws

Blade: Round

Design: Chrome-plated, Black Point

Handle: Kraftform Micro with non-roll feature and rotating cap, multi-component

Code	mm	mm	mm	mm	mm	mm	mm	mm
05030110001	PH 00	60	97	2.5	2 3/8"			5
05030111001	PH 0	60	97	3.0	2 3/8"			5
05030112001	PH 1	80	97	4.0	3 1/8"			5

1567 TORX® Kraftform Micro screwdriver for TORX® screws

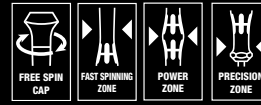

Application: TORX® socket screws

Blade: Round

Design: Chrome-plated, Black Point

Handle: Kraftform Micro with non-roll feature and rotating cap, multi-component

Code	mm	mm	mm	mm	mm	mm	mm	mm
05030120001	TX 4	40	97	2.5	1 9/16"			5
05030121001	TX 5	40	97	3.0	1 9/16"			5
05030122001	TX 6	40	97	3.0	1 9/16"			5

1567 TORX® B0 Kraftform Micro screwdriver for tamper-proof TORX® screws

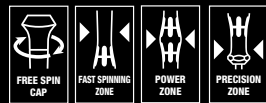

Application: TORX® socket screws with safety pin

(B0 = with bore hole)

Blade: Round

Design: Bore hole in TORX® section, chrome-plated, Black Point

Handle: Kraftform Micro with non-roll feature and rotating cap, multi-component

Code	mm	mm	mm	mm	mm	mm	mm	mm
05030123001	TX 7	60	97	3.0	2 3/8"			5
05030124001	TX 8	60	97	3.0	2 3/8"			5
05030125001	TX 9	60	97	4.0	2 3/8"			5
05030126001	TX 10	60	97	4.0	2 3/8"			5



ESD-safe

The requirements for ESD-safe screwdrivers are specified in the European standard EN 100-015 Part 1.

The Wera products in the ESD series satisfy these standards and the even more stringent requirements demanded by some technology companies.



European standard EN 100-015 Part 1

This standard also includes a handle that has to be out of a defined conductive material. The electric surface resistance of the Wera ESD material is between $10^6 - 10^9$ ohm. This securely protects components against electrostatic energy and associated damage.



Kraftform Micro screwdrivers – Fast-turning zone

The swivel head and the fast-turning zone just below the head allow rapid twisting.



Kraftform Micro screwdrivers – Power zone

The power zone has integrated soft zones near the blade tip to ensure high torque transfer for loosening or tightening screws without losing contact with the screw.



Kraftform Micro screwdrivers – Precision zone

The precision zone directly above the blade gives the user a better feel for the right rotation angle during fine adjustment work.

ESD Series

ESD-safe tools

1569 ESD Nutdriver

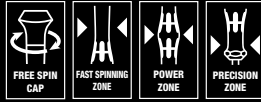

Application: Hexagon headed bolts, screws and nuts

Blade: Round

Design: Chrome-plated

Handle: Kraftform Micro with non-roll feature and rotating cap, multi-component

Code	mm	mm	mm	mm	mm		
05030150001	5.0	60	97	7.0	2 3/8"		5
05030151001	5.5	60	97	7.8	2 3/8"		5

1466 Kraftform Micro ESD pre-set torque screwdriver with quick-release chuck



Application: Suitable for bits with 4 mm Halfmoon drive (and Wera Serie 9) and 4 mm HIOS drive (and Wera Series 21)

Design: With quick-release chuck for rapid bit change

Pre-set torque: 0.65 kgfcm

Accuracy: ± 10%

Handle: Kraftform Micro with non-roll feature and rotating cap, multi-component

Code	Art.No.	kgfcm	kgfcm	mm	mm		
05300005001 ¹⁾	1466 ESD	0.65	0.5-1.1	130	5 1/8"		1

1460 Kraftform Micro ESD pre-set torque screwdriver with quick-release chuck

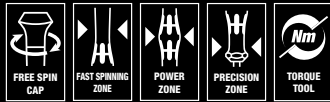

Application: Suitable for bits with 4 mm Halfmoon drive (and Wera Serie 9) and 4 mm HIOS drive (and Wera Series 21)

Design: With quick-release chuck for rapid bit change

Pre-set torque: 0.035 Nm

Accuracy: ± 10%

Handle: Kraftform Micro with non-roll feature and rotating cap, multi-component

Code	Art.No.	Nm	Nm	mm	mm		
05074800001	1460 ESD	0.035	0.02-0.06	133	5 1/8"		1

1430 Kraftform Micro ESD adjustable torque screwdrivers (0.02-0.11 Nm) with quick-release chuck



Application: Suitable for bits with 4 mm Halfmoon drive (and Wera Serie 9) and 4 mm HIOS drive (and Wera Series 21)

Design: With quick-release chuck for rapid bit change

Accuracy: ± 10%

Handle: Kraftform Micro with non-roll feature and rotating cap, multi-component

Code	Art.No.	Nm	Nm	mm	mm		
05074802001 ¹⁾	1430 ESD	0.02-0.06	0.0025	141	5 7/16"		1
05074804001 ¹⁾	1431 ESD	0.05-0.11	0.005	141	5 7/16"		1

¹⁾With attachable magnifying glass, dramatically improving visibility.

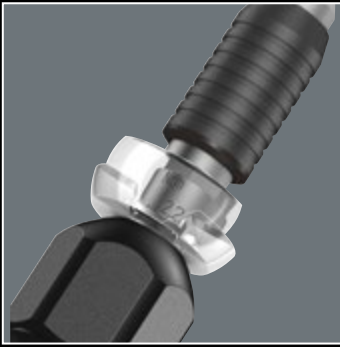

Attachable magnifying glass

Articles 1430 ESD and 1431 ESD all come with a magnifying glass. This can be easily attached on to the scale, dramatically improving visibility.



Halfmoon drive and HIOS drive

The Kraftform Micro ESD bitholding screwdriver is suitable both for bits with 4 mm Halfmoon drive (Wera Serie 9) and 4 mm HIOS drive (Wera Series 21).



Kraftform Kompakt Micro-Set

One handle – many applications. The Wera interchangeable blade system ensures that the user is equipped for any application. The quick-release chuck allows rapid bit change without additional tools. Simply insert the bit in the chuck and the automatic locking mechanism ensures a secure fit. To change the bit, just push the sleeve forwards and remove the bit.

ESD Series

ESD-safe tools

1013 Kraftform Micro ESD bitholding screwdriver

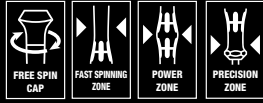

Application: Suitable for bits with 4 mm Halfmoon drive (and Wera Serie 9) and 4 mm HIOS drive (and Wera Series 21)

Design: With quick-release chuck for rapid bit change

Handle: Kraftform Micro with non-roll feature and rotating cap, multi-component

Code	mm	mm	mm						
05300004001	23	97	1"						1

Kraftform Kompakt Micro-Set ESD/20 SB

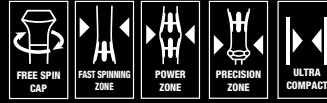

Pouch with 44 mm bits
20-piece set
1 Kraftform Micro ESD bitholding screwdriver

Code			
05073671001	⚡	1013 Kraftform 1 x 97 Micro ESD	1
	⊕	851/9 C 1 x PH 00x44; 1 x PH 0x44; 1 x PH 1x44	
	⊗	867/9 C TORX® 1 x TX 1x44; 1 x TX 2x44; 1 x TX 3x44; 1 x TX 4x44; 1 x TX 5x44; 1 x TX 6x44	
	⊗	867/9 C TORX PLUS® 1 x 1 IPx44; 1 x 2 IPx44; 1 x 3 IPx44; 1 x 4 IPx44	
	⊖	840/9 C 1 x 1.5x44; 1 x 2.0x44	
	⊖	800/9 C 1 x 0.23x1.5x44; 1 x 0.40x2.0x44; 1 x 0.50x3.0x44	
	⊗	873/9 Five Lobe 1 x # 1x44	



Series 7400 Krafftform ESD adjustable torque screwdrivers (0.1-3.0 Nm) with Rapidaptor quick-release chuck



Application: Suitable for 1/4" DIN 3126 C 6.3 and E 6.3 (ISO 1173) hexagon insert bits und Wera Series 1 and 4

Design: Rapidaptor rapid-in, rapid-out, rapid-spin, chuck-all and single-hand technology, non-magnetic

Accuracy: ±6 % (EN ISO 6789)

Handle: Krafftform with non-roll feature, multi-component

Code	Art.No.	mm	Nm	Nm	mm	mm	mm	mm
05074780001 ¹⁾	7430 ESD	89	1/4"	0.10-0.34	0,015	142	5 7/16"	1
05074782001 ¹⁾	7431 ESD	89	1/4"	0.30-1,00	0,05	142	5 7/16"	1
05074784001 ¹⁾	7432 ESD	89	1/4"	0.90-1,50	0,05	142	5 7/16"	1
05074730001	7440 ESD	105	1/4"	0.30-1,20	0,05	155	6"	1
05074731001	7441 ESD	105	1/4"	1,20-3,00	0,10	155	6"	1

¹⁾With attachable magnifying glass, dramatically improving visibility.

Series 7400 Krafftform ESD adjustable torque screwdrivers (2.5-29.0 in.lbs) with Rapidaptor quick-release chuck



Application: Suitable for 1/4" DIN 3126 C 6.3 and E 6.3 (ISO 1173) hexagon insert bits und Wera Series 1 and 4

Design: Rapidaptor rapid-in, rapid-out, rapid-spin, chuck-all and single-hand technology, non-magnetic

Accuracy: ±6 % (EN ISO 6789)

Handle: Krafftform with non-roll feature, multi-component

Code	Art.No.	in. lbs.	in. lbs.	mm	mm	mm	mm
05074733001	7445 ESD	1/4"	2.5-11.5	0.5	155	6"	1
05074734001	7446 ESD	1/4"	11.0-29.0	1.0	155	6"	1

813 R ESD bitholding screwdriver, non-magnetic



Application: Suitable for 1/4" DIN 3126-C and E 6.3 (ISO 1173) hexagon insert bits and Wera Series 1 and 4

Design: 1/4" hexagon socket with Wera quick-release chuck and Rapidaptor rapid-in, rapid-out, rapid-spin, chuck-all and single-hand technology

Handle: Krafftform with non-roll feature, multi-component

Code	mm	mm	mm	mm	mm	mm	mm
05051273001	1/4"	90					2

816 R ESD bitholding screwdriver, non-magnetic



Application: Suitable for 1/4" DIN 3126-C and E 6.3 (ISO 1173) hexagon insert bits and Wera Series 1 and 4

Design: 1/4" hexagon socket with Wera quick-release chuck and Rapidaptor rapid-in, rapid-out, rapid-spin, chuck-all and single-hand technology

Handle: Krafftform with non-roll feature, multi-component

Code	mm	mm	mm	mm	mm	mm	mm
05051464001	1/4"	119					2

ESD Series

ESD-safe tools

Series 7400 Kraftform ESD adjustable torque screwdrivers (0.1-1.0 Nm) with quick-release chuck



Application: Suitable for bits with 4 mm Halfmoon drive (and Wera Serie 9) and 4 mm HIOS drive (and Wera Series 21)

Design: With quick-release chuck for rapid bit change

Accuracy: $\pm 6\%$ (EN ISO 6789)

Handle: Kraftform with non-roll feature, multi-component

Code	Art.No.	mm	Nm	Nm	mm	mm	
05074786001	7435 ESD	89	0,10-0,34	0,015	142	5 7/16"	1
05074788001	7436 ESD	89	0,30-1,00	0,05	142	5 7/16"	1



Excess-load signal

Distinctly tactile and audible excess-load indication, when the desired torque is achieved.



Unlimited torque

Unlimited torque for loosening seized screws.



Attachable magnifying glass

Articles 7430 ESD, 7431 ESD, and 7432 ESD, 7435 ESD and 7436 ESD all come with a magnifying glass. This can be easily attached on to the scale, dramatically improving visibility.

Kraftform Kompakt VDE

Insulated versatile tools for work on live wiring

Kraftform Kompakt 60i+iS/62i/65i/67i/17



2x 817 VDE Kraftform handles, exclusively for Wera VDE interchangeable blades
 VDE exchangeable blades (each 154 mm long)
 17-piece set

Code			
05059030001	817 VDE	2 x 9x102	1
	KK 62 i	1 x PH 1x154; 1 x PH 2x154	
	KK 65 i PZ	1 x PZ 1x154; 1 x PZ 2x154	
	KK 65 i PZ/S	1 x # 1x154; 1 x # 2x154	
	KK 67 i TORX®	1 x TX 10x154; 1 x TX 15x154; 1 x TX 20x154; 1 x TX 25x154	
	KK 60 i	1 x 0.4x2.5x154; 1 x 0.8x4.0x154; 1 x 1.0x5.5x154; 1 x 1.2x6.5x154	
	KK 60 iS	1 x 0.6x3.5x154	

Kraftform Kompakt VDE 60 i/7



1 Kraftform hand-held bit holder 817 VDE for Wera interchangeable blades only
 VDE interchangeable blades (each 154 mm long)
 7-piece set

Code			
05003470001	817 VDE	1 x 9x102	1
	KK 62 i	1 x PH 1x154; 1 x PH 2x154	
	KK 60 i	1 x 0.4x2.5x154; 1 x 0.6x3.5x154; 1 x 0.8x4.0x154; 1 x 1.0x5.5x154	



Versatile

The handle/interchangeable blade system of the Kraftform Kompakt VDE sets allows rapid exchange of the blades required for a wide range of applications.



Safe

Each Kraftform Kompakt VDE set has been tested individually in a water bath at 10,000 volts, in accordance with DIN EN 60900 (IEC 60900).

This ten-times-higher testing load guarantees safe working at their maximum permitted load of 1,000 volts.

Kraftform Kompakt 25, 28

Bayonet blade models

Kraftform Kompakt 25 with pouch



Application: Suitable for 1/4" DIN 3126-C 6.3 and E 6.3 (ISO 1173) hexagon socket insert bits and Wera Series 1 and 4

Design: Attachment, bayonet, Rapidaptor rapid-in, rapid-out, rapid-spin, chuck-all and single-hand technology

Handle: Kraftform with non-roll feature, multi-component, integrated magazine

Code			
05051024001	⊕ 889/4 R	1 x 1/4"x100	1
	⊕ 851/1 Z PH	1 x PH 1x25; 1 x PH 2x25; 1 x PH 3x25	
	⊖ 800/1 Z	1 x 0.6x4.5x25; 1 x 1.0x5.5x25; 1 x 1.2x6.5x25	

Kraftform Kompakt 28 SB



Application: Suitable for 1/4" DIN 3126-C 6.3 (ISO 1173) hexagon socket insert bits and Wera Series 1

Design: Attachment, bayonet, with stainless steel sleeve, retaining ring, and strong permanent magnet

Handle: Kraftform with non-roll feature, multi-component, integrated magazine

Code			
05073240001	⊕ 851/1 Z PH	1 x PH 1x25; 1 x PH 2x25	1
	⊕ 855/1 Z PZ	1 x PZ 1x25; 1 x PZ 2x25	
	⊖ 800/1 Z	1 x 1.0x5.5x25; 1 x 1.2x6.5x25	



"Telescope" blade

When the unique unique extending blade is lowered into the handle, fast, easy screw-driving action is possible, even in the tightest spots! By pushing the clamping sleeve, the bayonet blade can be extended out of the handle and the compact tool becomes a full-sized screwdriver. If the clamping sleeve is pushed again the bayonet blade can be taken out of the handle, and be used as a machine bit adaptor.



Bit magazine

Six bits are conveniently integrated into a push-button opening bit magazine. The Rapidaptor technology ensures rapid one hand bit changes, press-in auto bit lock and a secure positioning when used in power tools thanks to the free-turning sleeve.



Kraftform Kompakt 60, 61

Bits of 89 mm in length

Kraftform Kompakt 60



Pouch with 89 mm bits
17-piece set
1 Kraftform bitholding screwdriver 816 R with Rapidaptor quick-release chuck

Code	Icon	Item	Quantity	Unit
05059295001	●	816 R	1 x 1/4"x119	1
	⊕	851/4 Z PH	1 x PH 1x89; 1 x PH 2x89; 1 x PH 3x89	
	⊕	855/4 Z PZ	1 x PZ 1x89; 1 x PZ 2x89; 1 x PZ 3x89	
	⊕	867/4 Z TORX®	1 x TX 10x89; 1 x TX 15x89; 1 x TX 20x89; 1 x TX 25x89; 1 x TX 30x89	
	●	800/4 Z	1 x 1.0x5.5x89	
	○	840/4 Z Hex-Plus	1 x 3.0x89; 1 x 4.0x89; 1 x 5.0x89; 1 x 6.0x89	

Kraftform Kompakt 61



Pouch with 89 mm bits
17-piece set
1 Kraftform bitholding screwdriver 816 R with Rapidaptor quick-release chuck

Code	Icon	Item	Quantity	Unit
05059296001	●	816 R	1 x 1/4"x119	1
	⊕	867/4 Z TORX®	1 x TX 10x89; 1 x TX 15x89; 1 x TX 20x89; 1 x TX 25x89; 1 x TX 30x89	
	⊕	871/4 TORQ-SET® Mplus	1 x 6x89; 1 x 8x89; 1 x 10x89	
	⊕	875/4 TRI-WING®	1 x 1x89; 1 x 2x89; 1 x 3x89; 1 x 4x89	
	●	857/4 Z Spanner	1 x 4x89; 1 x 6x89; 1 x 8x89; 1 x 10x89	

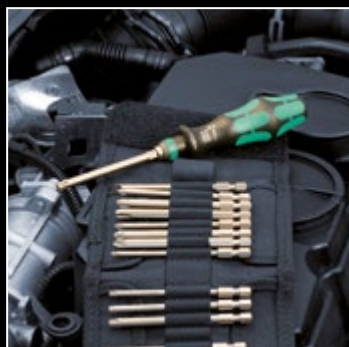

Manual and power tool

The sets come with a Kraftform handle, quick-release chuck and bits for manual and power tool operations. The handle/interchangeable blade system permits rapid exchange of the blades needed for a wide range of applications.

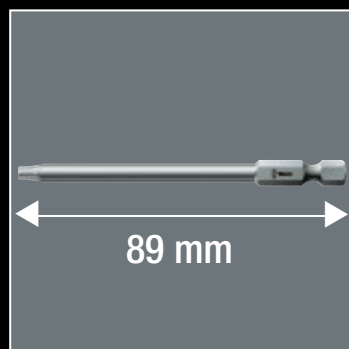

Extra long

The Kraftform Kompakt 60 pouches include a bitholding screwdriver and 89 mm long bits.



Rapidaptor chuck

The Rapidaptor quick-release chucks hold all 1/4" hexagon bits. The bit can be pushed into the adaptor without moving the sleeve. The lock is activated automatically as soon as the bit is applied to the screw. Bits are held securely and wobble-free. Simply push the sleeve forward to change the bit. The spring mechanism lifts the bit off the magnet and unlocks the tool. The rapid-out function makes it easy to remove even the smallest bits without extra tools.

Bitholding Screwdrivers and Adaptors

Suitable for hand and power tool applications

816 R Bitholding screwdriver with Rapidaptor quick-release chuck



Application: Suitable for 1/4" DIN 3126-C 6.3 and E 6.3 (ISO 1173) hexagon insert bits and Wera Series 1 and 4

Drive: 1/4" hexagon with Rapidaptor rapid-in, rapid-out, rapid-spin, chuck-all and single-hand technology, magnetic

Handle: Kraftform with non-roll feature, multi-component

Code			mm					
05051462001	1/4"	119						5

810/1 Bitholding screwdriver with retaining ring



Application: Suitable for 1/2" DIN 3126-C 6.3 (ISO 1173) hexagon insert bits and Wera Series 1

Blade: Hexagon

Design: Retaining ring, chrome-plated

Handle: Kraftform with non-roll feature, multi-component

Code								
Code	mm	mm	mm	mm				
05051005001	1/4"	120	112	10.5	4 3/4"			2

817 R Bitholding screwdriver with Rapidaptor quick-release chuck



Application: Suitable for 1/4" DIN 3126-C 6.3 and E 6.3 (ISO 1173) hexagon insert bits and Wera Series 1 and 4

Drive: 2 position telescopic blade, can be retracted into the handle for confined space operation or extended for more reach, can also be removed and used as a 100mm bit holder in the power tool, 1/4" hexagon suitable for power tools with DIN 3126-F 6.3, ISO 1173 chuck

Design: 1/4" hexagon with Rapidaptor rapid-in, rapid-out, rapid-spin, chuck-all and single-hand technology, magnetic

Handle: Kraftform with non-roll feature, multi-component

Code			mm					
05051482001	1/4"	133						2

Bit Holder with Stainless Steel Sleeve

The bitholding screwdriver 810/1 comes with stainless steel sleeve, strong retaining ring, and strong permanent magnet. The retaining ring is a tried and tested adapter shape that ensures that the tool is held firmly in the holder.



Kraftform Kompakt Vario with Ratchet Function

High working speeds

Kraftform Kompakt 27 RA 1 SB



Application: Suitable for hexagon socket insert bits as per DIN 3126-C 6.3 (ISO 1173) and Wera series 1

Design: Ratchet, fine-tooth design for minimal return angle, switchover ring (right, locked, left), maximum torque of up to 50 Newton metres, hexagon blade with 1/4" hexagon chuck, stainless steel sleeve, strong permanent magnet

Handle: Kraftform with non-roll feature, multi-component, integrated magazine

Code				
05073660001	+	851/1 Z PH	1 x PH 1x25; 1 x PH 2x25	1
	+	855/1 Z PZ	1 x PZ 1x25; 1 x PZ 2x25	
	⊖	800/1 Z	1 x 1.0x5.5x25; 1 x 1.2x6.5x25	

Kraftform Kompakt 60 RA



Pouch with 89 mm bits
17-piece set

1 hand-held bit holder 816 RA Kraftform with ratchet function, fine-tooth design for minimal return angle, switchover ring (right, locked, left), maximum torque of up to 50 Newton metres, 1/4" hexagon chuck with Rapidaptor technology i.e. rapid-in, rapid-out, rapid-spin, chuck-all and single-hand function for rapid bit change, magnetic and 16 bits of 89 mm in length suitable for holders as per DIN 3126-F 6.3, ISO 1173, or for direct insertion in a power tool

Kraftform Kompakt 60 RA, imperial



Pouch with 89 mm bits
17-piece set

1 hand-held bit holder 816 RA Kraftform with ratchet function, fine-tooth design for minimal return angle, switchover ring (right, locked, left), maximum torque of up to 50 Newton metres, 1/4" hexagon chuck with Rapidaptor technology i.e. rapid-in, rapid-out, rapid-spin, chuck-all and single-hand function for rapid bit change, magnetic and 16 bits of 89 mm in length suitable for holders as per DIN 3126-F 6.3, ISO 1173 or for direct insertion in a power tool

Code				
05051040001	⊙	816 RA	1 x 1/4"x142.0	1
	+	851/4 Z PH	1 x PH 1x89; 1 x PH 2x89; 1 x PH 3x89	
	+	855/4 Z PZ	1 x PZ 1x89; 1 x PZ 2x89; 1 x PZ 3x89	
	⊕	867/4 Z TORX®	1 x TX 10x89; 1 x TX 15x89; 1 x TX 20x89;	
		B0	1 x TX 25x89; 1 x TX 30x89	
	⊖	800/4 Z	1 x 1.0x5.5x89	
	○	840/4 Z Hex-Plus	1 x 3.0x89; 1 x 4.0x89; 1 x 5.0x89;	
			1 x 6.0x89	

Code				
05051041001	⊙	816 RA	1 x 1/4"x142.0	1
	+	851/4 Z PH	1 x PH 1x89; 1 x PH 2x89; 1 x PH 3x89	
	⊕	867/4 Z TORX®	1 x TX 10x89; 1 x TX 15x89; 1 x TX 20x89;	
		B0	1 x TX 25x89; 1 x TX 30x89	
	⊖	800/4 Z	1 x 1.0x5.5x89	
	○	840/4 Z Hex-Plus	1 x 3/32"x89; 1 x 1/8"x89; 1 x 5/32"x89;	
			1 x 3/16"x89	
	○	868/4 Square-Plus	1 x # 1x89; 1 x # 2x89; 1 x # 3x89	



Kraftform Kompakt 27 RA with bit magazine

Six bits are conveniently integrated into a push-button opening bit magazine.

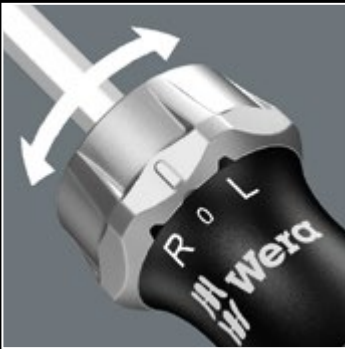

Robust ratchet

Simply the best: the combination of the Kraftform Kompakt system, and a ratcheting screwdriver. Ergonomically designed reversing switch. The low return angle of only 8 degrees allows fast, precise work, even in tight spots with a torque of up to 50 Nm. Fine action 44 tooth system. Great time savings when screwdriving. Ergonomic design of the reverse direction switch.

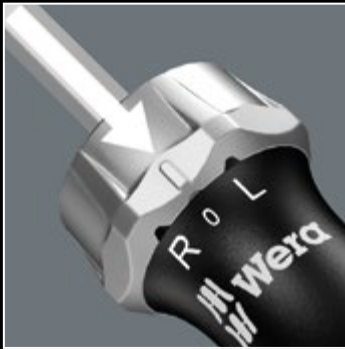

Neutral position

Additionally, the lockable neutral position permits exact adjustment work without having to change the screwdriving direction every time.



Pouch with 89 mm bits

Practical packaging. Ideally suited for mobile use.

L-Keys for Hexagon Socket Screws

The Hex-Plus profile extends the service life of hexagon socket screws

950 SPKL L-key Multicolour, metric, BlackLaser

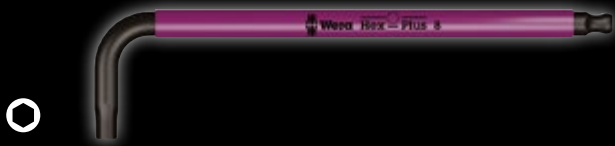

Application: Hexagon socket screws

Design: BlackLaser surface, durable plastic sleeve

Tip: Hex-Plus, ball-end hexagon on long arm

Code	mm	mm	mm	mm	mm	mm	mm
0502260001	1.5	90	14	3 1/2"	9/16"		10
0502260201	2.0	101	16	4"	5/8"		10
0502260401	2.5	112	19	4 7/16"	3/4"		10
0502260601	3.0	123	21	4 7/8"	27/32"		10
0502260801	4.0	137	24	5 3/8"	1"		10
0502261001	5.0	154	27	6 1/16"	1 1/16"		10
0502261201	6.0	172	31	6 3/4"	1 1/4"		10
0502261401	8.0	195	37	7 11/16"	1 7/16"		10
0502261601	10.0	224	42	9"	1 11/16"		10

950 SPKL/9 SM N Multicolour L-key set, metric, BlackLaser



9-piece set. Wera Hex-Plus L-keys have a larger contact surface inside the screw recess. This reduces the notching effect and thereby also the deformation of the screwhead. At the same time up to 20 % more torque can be transferred. The ball-end on the long arm enables angled access to drive screws in awkward places. L-keys with thermoplastic sleeve (SPKL) are manufactured out of easy-to-grip, circular material. The sleeve ensures that work is safe and comfortable even at low temperatures. High corrosion protection features thanks to the special BlackLaser surface treatment. The contrasting inscriptions on the colour-coded sleeves mean that it is easy to recognise the correct sizes and this makes it simpler to find the right tool. The wear-resistant clip material ensures that the L-keys are securely held yet are easy to remove.

Code			
05073593001	950 SPKL Multicolour	1 x 1.5x90; 1 x 2.0x101; 1 x 2.5x112; 1 x 3.0x123; 1 x 4.0x137; 1 x 5.0x154; 1 x 6.0x172; 1 x 8.0x195; 1 x 10.0x224	1

950 SPKL L-key, imperial, BlackLaser

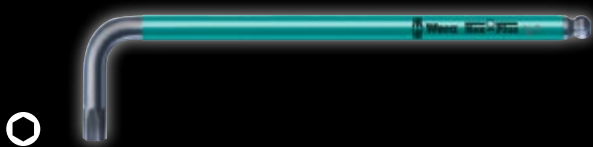

Application: Hexagon socket screws

Design: BlackLaser surface, durable plastic sleeve

Tip: Hex-Plus, ball-end hexagon on long arm

Code	mm	mm	mm	mm	mm	mm	mm
05022519001	5/64"	101	16	4"	5/8"		10
05022520001	3/32"	112	19	4 7/16"	3/4"		10
05022521001	1/8"	123	21	4 7/8"	27/32"		10
05022522001	5/32"	137	24	5 3/8"	1"		10
05022523001	3/16"	154	27	6 1/16"	1 1/16"		10
05022524001	7/32"	172	31	6 3/4"	1 1/4"		10
05022525001	1/4"	185	34	7 1/4"	1 5/16"		10
05022526001	5/16"	195	37	7 11/16"	1 7/16"		10
05022527001	3/8"	224	42	9"	1 11/16"		10



**Hex-Plus Tools
Available by Wera only**

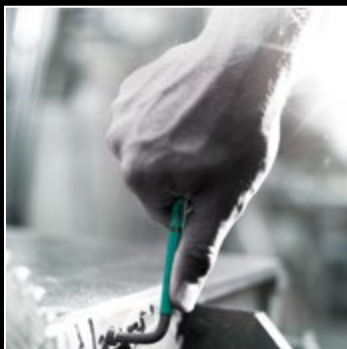

SPKL – protects fingers!

Wera L-keys with a thermoplastic sleeve (SPKL) are manufactured out of easy-to-grip, circular material. The sleeve ensures that work is safe and comfortable even at low temperatures. High corrosion protection features thanks to the special BlackLaser surface treatment. The contrasting inscriptions on the colour-coded sleeves mean that it is easy to recognise the correct sizes and this makes it simpler to find the right tool.

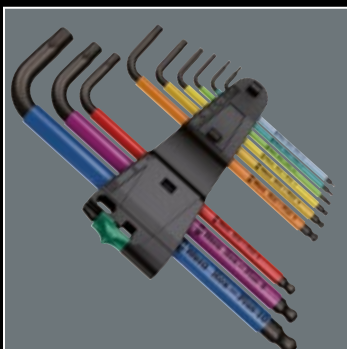

Wear-resistant clip material

The wear-resistant clip material ensures that the L-keys are securely held yet are easy to remove.

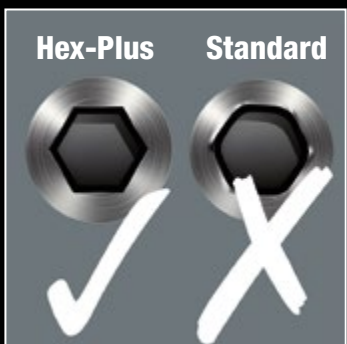

Hex-Plus profile

Hexagon socket screws are prone to rounding out, because the typical profile attempts to transfer high torque over small, sharp edges. Hex-Plus tools have a unique profile that spreads those loads over larger contact points, preventing fastener damage. The best news is, Hex-Plus tools will fit any standard hex-recess fastener. At the same time up to 20 % more torque can be transferred.

Hexagon L-Keys Stainless Steel

Prevent rusting stainless steel

3950 PKL L-key, imperial, stainless



Application: Hexagon socket screws

Design: Stainless steel

Tip: Hex-Plus, ball-end hexagon on long arm

Code	mm	mm	mm	mm	mm	mm	mm
05022710001	3/32"	112	19	4 7/16"	3/4"		10
05022711001	7/64"	119	20	4 3/4"	25/32"		10
05022712001	1/8"	123	21	4 7/8"	27/32"		10
05022713001	9/64"	130	22	5 3/16"	29/32"		10
05022714001	5/32"	137	24	5 3/8"	1"		10
05022715001	3/16"	154	27	6 1/16"	1 1/16"		10
05022716001	1/4"	185	34	7 1/4"	1 5/16"		10
05022717001	5/16"	195	37	7 11/16"	1 7/16"		10
05022718001	3/8"	224	42	9"	1 11/16"		5

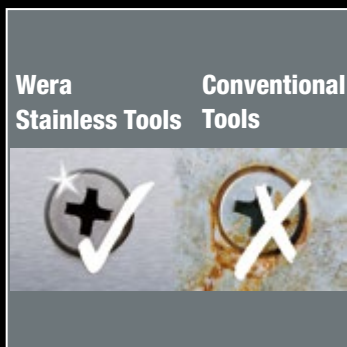

Prevent rusting stainless steel

Stainless steel tools prevent corrosion in stainless fasteners, caused by dissimilar metal contamination, and saves on costly re-fitting.



Vacuum ice-hardened

Stainless steel tools from Wera are vacuum ice-hardened and have the hardness and strength needed for reliable screw connections. There are no limitations to the industrial applications they are suitable for.

3950 PKL L-key, metric, stainless



Application: Hexagon socket screws

Design: Stainless steel

Tip: Hex-Plus, ball-end hexagon on long arm

Code	mm	mm	mm	mm	mm	mm	mm
05022700001	1.5	90	14	3 1/2"	9/16"		10
05022701001	2.0	101	16	4"	5/8"		10
05022702001	2.5	112	19	4 7/16"	3/4"		10
05022703001	3.0	123	21	4 7/8"	27/32"		10
05022704001	4.0	137	24	5 3/8"	1"		10
05022705001	5.0	154	27	6 1/16"	1 1/16"		10
05022706001	6.0	172	31	6 3/4"	1 1/4"		10
05022708001	8.0	195	37	7 11/16"	1 7/16"		10
05022709001	10.0	224	42	9"	1 11/16"		10

3950 PKL/9 SZ L-key set, imperial, stainless

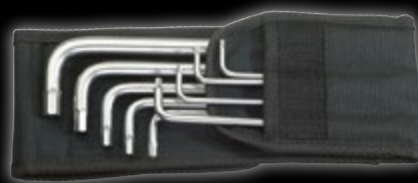

9-piece set in belt pouch

Code	mm	mm	mm	mm	mm	mm	mm				
05022721001	3950 PKL inch	1 x 3/32"x112;	1 x 7/64"x119;	1 x 1/8"x123;	1 x 9/64"x130;	1 x 5/32"x137;	1 x 3/16"x154;	1 x 1/4"x185;	1 x 5/16"x195;	1 x 3/8"x224	1

3950 PKL/9 L-key set, metric, stainless



9-piece set in a two-component clip

Code	mm	mm	mm	mm	mm	mm	mm				
05022720001	3950 PKL	1 x 1.5x90;	1 x 2.0x101;	1 x 2.5x112;	1 x 3.0x123;	1 x 4.0x137;	1 x 5.0x154;	1 x 6.0x172;	1 x 8.0x195;	1 x 10.0x224	10

Hexagon L-Keys BlackLaser

For outstanding surface protection



BlackLaser

Hexagon L-keys with BlackLaser surface treatment for outstanding surface protection and long service life. High corrosion protection.

950 PKL L-key, imperial, BlackLaser



Application: Hexagon socket screws

Design: BlackLaser surface

Tip: Hex-Plus, ball-end hexagon on long arm

Code	⊘	L ₁ mm	L ₂ mm	L ₃ "	L ₄ "			
05022079001 ¹⁾	0.05"	83	14	3 1/4"	9/16"			10
05022081001 ¹⁾	1/16"	91	15	3 1/2"	19/32"			10
05022068001	5/64"	100	16	4"	5/8"			10
05022070001	3/32"	112	18	4 7/16"	23/32"			10
05022071001	7/64"	119	19	4 3/4"	3/4"			10
05022072001	1/8"	126	20	5"	25/32"			10
05022073001	9/64"	132	23	5 3/16"	29/32"			10
05022074001	5/32"	140	25	5 1/2"	1"			10
05022076001	3/16"	160	25	6 5/16"	1"			10
05022078001	7/32"	180	27	7 1/16"	1 1/16"			10
05022080001	1/4"	190	34	7 1/2"	1 5/16"			10
05022082001	5/16"	200	36	8"	1 7/16"			10
05022095001	3/8"	212	38	8 3/8"	1 1/2"			5
05022096001	1/2"	224	40	9"	1 9/16"			5

¹⁾ Regular hexagon

950 PKL BM L-key, metric, BlackLaser



Application: Hexagon socket screws

Design: BlackLaser surface

Tip: Hex-Plus, ball-end hexagon on long arm

Code	⊘ mm	L ₁ mm	L ₂ mm	L ₃ "	L ₄ "			
05027101001 ¹⁾	1.5	90	14	3 1/2"	9/16"			10
05027102001	2.0	100	16	4"	5/8"			10
05027103001	2.5	112	18	4 7/16"	23/32"			10
05027104001	3.0	126	19	5"	3/4"			10
05027105001	4.0	140	25	5 1/2"	1"			10
05027106001	5.0	160	28	6 5/16"	1 3/32"			10
05027107001	6.0	180	32	7 1/16"	1 1/4"			10
05027110001	7.0	190	34	7 1/2"	1 5/16"			10
05027108001	8.0	200	36	8"	1 7/16"			10
05027109001	10.0	219	40	8 11/16"	1 9/16"			10
05027111001	12.0	248	45	10"	1 3/4"			5

¹⁾ Regular hexagon

L-Keys for TORX® Screws

Ball end tip for working at an angle

967 SPKL TORX® BO L-key Multicolour, BlackLaser



Application: TORX® socket screws with and without pin (BO = bore hole)

Design: BlackLaser, durable plastic sleeve

Tip: TORX® on short arm, TORX® ball end on long arm

Code	TX	mm	mm	mm	mm		
05024350001 ¹⁾	TX 8	76	16	3"	5/8"		10
05024351001 ¹⁾	TX 9	79	16	3 1/8"	5/8"		10
05024352001 ²⁾	TX 10	85	17	3 3/8"	21/32"		10
05024353001	TX 15	90	18	3 1/2"	23/32"		10
05024354001	TX 20	96	19	3 3/4"	3/4"		10
05024355001	TX 25	104	21	4 1/8"	27/32"		10
05024356001	TX 27	112	22	4 7/16"	29/32"		10
05024357001	TX 30	122	24	4 13/16"	1"		10
05024358001	TX 40	132	27	5 3/16"	1 1/16"		10

¹⁾ Product without bore hole at the short and without ball-end at the long arm.

²⁾ Product without ball-end at the long arm.

967 SPKL/9 TORX® BO Multicolour L-key set for tamper-proof TORX® screws, BlackLaser



9-piece set in a two-component clip with magnetising device. For socket TORX® screws and socket TORX® screws with pin (BO = bore hole). TORX® BO (BO = bore hole) on short shaft, TORX® ball tip on long shaft; thereby enabling screwdriving jobs at slightly inclined angles; safe work even in difficult ambient conditions. L-keys with plastic sleeve (SPKL) are manufactured out of easy-to-grip circular material. The sleeves make work convenient and safe even at low temperatures. All L-keys are quickly to hand thanks to their colour coding and size marking. The wear-resistant clip material ensures that the L-keys are securely held yet are easy to remove.

Code			
05073599001	967 SPKL TORX® BO Multicolour	1 x TX 8x76 ¹⁾ ; 1 x TX 9x79 ¹⁾ ; 1 x TX 10x85 ²⁾ ; 1 x TX 15x90; 1 x TX 20x96; 1 x TX 25x104; 1 x TX 27x112; 1 x TX 30x122; 1 x TX 40x132	1

¹⁾ Product without bore hole at the short and without ball-end at the long arm.

²⁾ Product without ball-end at the long arm.



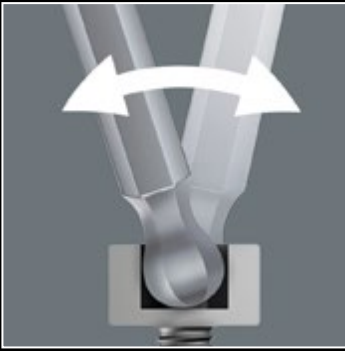

Ball head

The ball-point tip makes it possible to work effectively, in those hard-to-reach screwdriving jobs.



SPKL – protects fingers!

Wera L-keys with a thermoplastic sleeve (SPKL) are manufactured out of easy-to-grip, circular material. The sleeve ensures that work is safe and comfortable even at low temperatures. High corrosion protection features thanks to the special BlackLaser surface treatment. The contrasting inscriptions on the colour-coded sleeves mean that it is easy to recognise the correct sizes and this makes it simpler to find the right tool.

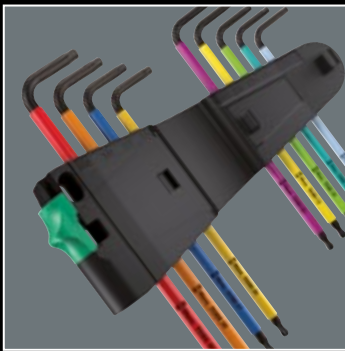

Wear-resistant clip material

The wear-resistant clip material ensures that the L-keys are securely held yet are easy to remove.



SPKL – protects fingers!

Wera L-keys with a thermoplastic sleeve (SPKL) are manufactured out of easy-to-grip, circular material. The sleeve ensures that work is safe and comfortable even at low temperatures. High corrosion protection features thanks to the special BlackLaser surface treatment. The contrasting inscriptions on the colour-coded sleeves mean that it is easy to recognise the correct sizes and this makes it simpler to find the right tool.



Contact us

All regions (except for North America, UK and Republic of Ireland)

Wera Werk · Germany
Korzeter Straße 21-25
D-42349 Wuppertal

Phone: +49 (0)202 / 40 45-322
Fax: +49 (0)202 / 40 36 34
E-Mail: info@wera.de

Internet:
www.wera.de

North America

Wera Tools Inc.
4129 Harvester Rd, Unit H
Burlington, Ontario
Canada, L7L 5M3

Phone: 1-800-267-5541
E-Mail: info@weratools.com

Internet:
www.weratools.com

UK & Republic of Ireland

Wera Tools UK LTD
Units 1 & 2, McGregor's Way
Turnoaks Business Park, Chesterfield
Derbyshire, S40 2WB
Great Britain

Phone: +44 (0)1246/27 77 56
E-Mail: queries@wera-tools.co.uk

Internet:
www.wera-tools.co.uk